

**DENON**

**AVR-1513**  
AV SURROUND RECEIVER

**Owner's Manual**

## SAFETY PRECAUTIONS



**CAUTION**  
**RISK OF ELECTRIC SHOCK**  
**DO NOT OPEN**



**CAUTION:**  
**TO REDUCE THE RISK OF ELECTRIC SHOCK, DO NOT REMOVE COVER (OR BACK). NO USER-SERVICEABLE PARTS INSIDE. REFER SERVICING TO QUALIFIED SERVICE PERSONNEL.**

The lightning flash with arrowhead symbol, within an equilateral triangle, is intended to alert the user to the presence of uninsulated "dangerous voltage" within the product's enclosure that may be of sufficient magnitude to constitute a risk of electric shock to persons.

The exclamation point within an equilateral triangle is intended to alert the user to the presence of important operating and maintenance (servicing) instructions in the literature accompanying the appliance.

**WARNING:**  
**TO REDUCE THE RISK OF FIRE OR ELECTRIC SHOCK, DO NOT EXPOSE THIS APPLIANCE TO RAIN OR MOISTURE.**



Hot surface mark

**CAUTION:**  
**HOT SURFACE. DO NOT TOUCH.**

The top surface over the internal heat sink may become hot when operating this product continuously. Do not touch hot areas, especially around the "Hot surface mark" and the top panel.

## IMPORTANT SAFETY INSTRUCTIONS

1. Read these instructions.
2. Keep these instructions.
3. Heed all warnings.
4. Follow all instructions.
5. Do not use this apparatus near water.
6. Clean only with dry cloth.
7. Do not block any ventilation openings. Install in accordance with the manufacturer's instructions.
8. Do not install near any heat sources such as radiators, heat registers, stoves, or other apparatus (including amplifiers) that produce heat.
9. Do not defeat the safety purpose of the polarized or grounding-type plug. A polarized plug has two blades with one wider than the other. A grounding type plug has two blades and a third grounding prong. The wide blade or the third prong are provided for your safety. If the provided plug does not fit into your outlet, consult an electrician for replacement of the obsolete outlet.
10. Protect the power cord from being walked on or pinched particularly at plugs, convenience receptacles, and the point where they exit from the apparatus.
11. Only use attachments/accessories specified by the manufacturer.
12. Use only with the cart, stand, tripod, bracket, or table specified by the manufacturer, or sold with the apparatus. When a cart is used, use caution when moving the cart/apparatus combination to avoid injury from tip-over.
13. Unplug this apparatus during lightning storms or when unused for long periods of time.
14. Refer all servicing to qualified service personnel. Servicing is required when the apparatus has been damaged in any way, such as power-supply cord or plug is damaged, liquid has been spilled or objects have fallen into the apparatus, the apparatus has been exposed to rain or moisture, does not operate normally, or has been dropped.
15. Batteries shall not be exposed to excessive heat such as sunshine, fire or the like.



### CAUTION:

To completely disconnect this product from the mains, disconnect the plug from the wall socket outlet. The mains plug is used to completely interrupt the power supply to the unit and must be within easy access by the user.

## FCC INFORMATION (For US customers)

### 1. PRODUCT

This product complies with Part 15 of the FCC Rules. Operation is subject to the following two conditions: (1) this product may not cause harmful interference, and (2) this product must accept any interference received, including interference that may cause undesired operation.

### 2. IMPORTANT NOTICE: DO NOT MODIFY THIS PRODUCT

This product, when installed as indicated in the instructions contained in this manual, meets FCC requirements. Modification not expressly approved by DENON may void your authority, granted by the FCC, to use the product.

### 3. NOTE

This product has been tested and found to comply with the limits for a Class B digital device, pursuant to Part 15 of the FCC Rules. These limits are designed to provide reasonable protection against harmful interference in a residential installation.

This product generates, uses and can radiate radio frequency energy and, if not installed and used in accordance with the instructions, may cause harmful interference to radio communications. However, there is no guarantee that interference will not occur in a particular installation. If this product does cause harmful interference to radio or television reception, which can be determined by turning the product OFF and ON, the user is encouraged to try to correct the interference by one or more of the following measures:

- Reorient or relocate the receiving antenna.
- Increase the separation between the equipment and receiver.
- Connect the product into an outlet on a circuit different from that to which the receiver is connected.
- Consult the local retailer authorized to distribute this type of product or an experienced radio/TV technician for help.

### For Canadian customers:

This Class B digital apparatus complies with Canadian ICES-003.

## NOTES ON USE

### WARNINGS

- Avoid high temperatures.  
Allow for sufficient heat dispersion when installed in a rack.
- Handle the power cord carefully.  
Hold the plug when unplugging the cord.
- Keep the unit free from moisture, water, and dust.
- Unplug the power cord when not using the unit for long periods of time.
- Do not obstruct the ventilation holes.
- Do not let foreign objects into the unit.
- Do not let insecticides, benzene, and thinner come in contact with the unit.
- Never disassemble or modify the unit in any way.
- Ventilation should not be impeded by covering the ventilation openings with items, such as newspapers, tablecloths or curtains.
- Naked flame sources such as lighted candles should not be placed on the unit.
- Observe and follow local regulations regarding battery disposal.
- Do not expose the unit to dripping or splashing fluids.
- Do not place objects filled with liquids, such as vases, on the unit.
- Do not handle the mains cord with wet hands.
- When the switch is in the OFF (STANDBY) position, the equipment is not completely switched off from MAINS.
- The equipment shall be installed near the power supply so that the power supply is easily accessible.

## CAUTIONS ON INSTALLATION

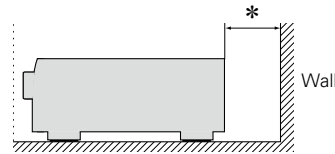
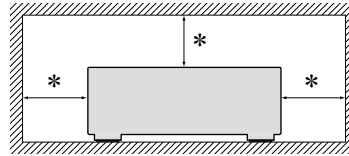

**\* For proper heat dispersal, do not install this unit in a confined space, such as a bookcase or similar enclosure.**

- More than 12 in. (0.3 m) is recommended.
- Do not place any other equipment on this unit.

# Getting started

Thank you for purchasing this DENON product. To ensure proper operation, please read this owner's manual carefully before using the product. After reading them, be sure to keep them for future reference.

## Contents

<b>Getting started</b> .....	<a href="#">1</a>
Accessories .....	<a href="#">1</a>
Features .....	<a href="#">2</a>
Cautions on handling .....	<a href="#">2</a>

## Basic version .....

[3](#)

<b>Connections</b> .....	<a href="#">4</a>
Important information .....	<a href="#">4</a>
Connecting an HDMI-compatible device .....	<a href="#">5</a>
Connecting an HDMI-incompatible device .....	<a href="#">9</a>
<b>Playback (Basic operation)</b> .....	<a href="#">14</a>
Important information .....	<a href="#">14</a>
Playing a Blu-ray Disc player/DVD player .....	<a href="#">15</a>
Playing a portable player .....	<a href="#">15</a>
Tuning in radio stations .....	<a href="#">16</a>
<b>Selecting a listening mode (Surround mode)</b> .....	<a href="#">18</a>
Standard playback .....	<a href="#">19</a>
Multi channel stereo playback .....	<a href="#">20</a>
Virtual playback .....	<a href="#">20</a>
Stereo playback .....	<a href="#">20</a>
Direct playback .....	<a href="#">20</a>

## Advanced version .....

[21](#)

<b>Speaker installation/connection (Advanced connection)</b> .....	<a href="#">22</a>
Speaker installation .....	<a href="#">22</a>
Speaker connection .....	<a href="#">23</a>
<b>Playback (Advanced operation)</b> .....	<a href="#">25</a>
Convenient functions .....	<a href="#">25</a>
<b>How to make detailed settings</b> .....	<a href="#">27</a>
Menu map .....	<a href="#">27</a>
Examples of menu and front display .....	<a href="#">28</a>
Input Setup .....	<a href="#">29</a>
Option Setup .....	<a href="#">32</a>
Adjusting the sound field effects .....	<a href="#">34</a>
Information .....	<a href="#">38</a>

## Information .....

[39](#)

<b>Part names and functions</b> .....	<a href="#">40</a>
Front panel .....	<a href="#">40</a>
Display .....	<a href="#">41</a>
Rear panel .....	<a href="#">42</a>
Remote control unit .....	<a href="#">43</a>
<b>Other information</b> .....	<a href="#">45</a>
Trademark information .....	<a href="#">45</a>
Surround .....	<a href="#">46</a>
Relationship between video signals and monitor output .....	<a href="#">49</a>
Explanation of terms .....	<a href="#">50</a>
<b>Troubleshooting</b> .....	<a href="#">52</a>
Resetting the microprocessor .....	<a href="#">54</a>
<b>Specifications</b> .....	<a href="#">54</a>

## Accessories

Check that the following parts are supplied with the product.

① Getting Started .....	1
② CD-ROM (Owner's manual) .....	1
③ Warranty (for North America model only) .....	1
④ Service network list .....	1
⑤ Remote control unit (RC-1170) .....	1
⑥ R03/AAA batteries .....	2
⑦ AM loop antenna .....	1
⑧ FM indoor antenna .....	1



## Features

### Fully discrete, identical quality and power for all 5 channels (110 W x 5ch)

The unit is equipped with a power amplifier that reproduces high-fidelity sound in surround mode with equal quality and power for all channels, true to the original sound.

The power amplifier circuit adopts a discrete-circuit configuration that achieves high-quality surround sound reproduction.

### HDMI connectors enable connection to various digital AV devices (input: 4, output: 1)

(👉 [page 5](#))

The unit is equipped with 4 HDMI input connectors for connecting devices with HDMI connectors, such as a set-top box, Blu-ray Disc player, game machine, HD digital camcorder, etc.

### Supports HDMI (3D, Deep Color and "x.v.Color")

(👉 [page 8](#))

This unit can output 3D video signals input from a Blu-ray Disc player to a TV that supports a 3D system.

### High definition audio support

The unit is equipped with a decoder which supports high-quality digital audio format for Blu-ray Disc players such as Dolby TrueHD, DTS-HD Master Audio, etc.

### Features an AUX PORTABLE IN jack on the front panel for connecting portable audio player

(👉 [page 13](#))

Compressed Audio Restorer is DENON technology that restores compressed music sources to their original pre-compressed quality to give you a lively sonic ambience with greater detail and depth.

### GUI overlay on HD source

You can easily make settings for your home theatre system while viewing menus on the TV screen. These menu displays can also be output to the monitor over HDMI.

### Easy to use, screen display

Simple settings are enabled with the setting menus displayed on the TV screen. When you control the sound volume, the volume level is displayed on the screen, and when you switch the input source, the name of the input source is displayed.

## Cautions on handling

### • Before turning the power on

Check once again that all connections are correct and that there are no problems with the connection cables.

- Power is supplied to some of the circuitry even when the unit is set to the standby mode. When going on vacation or leaving home for long periods of time, be sure to unplug the power cord from the power outlet.

### • About condensation

If there is a major difference in temperature between the inside of the unit and the surroundings, condensation (dew) may form on the operating parts inside the unit, causing the unit not to operate properly.

If this happens, let the unit sit for an hour or two with the power turned off and wait until there is little difference in temperature before using the unit.

### • Cautions on using mobile phones

Using a mobile phone near this unit may result in noise. If that occurs, move the mobile phone away from this unit when it is in use.

### • Moving the unit

Turn off the power and unplug the power cord from the power outlet. Next, disconnect the connection cables to other system units before moving the unit.



### • About care

- Wipe the cabinet and control panel clean with a soft cloth.
- Follow the instructions when using a chemical cleaner.
- Benzene, paint thinner or other organic solvents as well as insecticide may cause material changes and discoloration if brought into contact with the unit, and should therefore not be used.

## Basic version

---

Here, we explain the connections and basic operation methods for this unit.

- **Connections**  [page 4](#)
- **Playback (Basic operation)**  [page 14](#)
- **Selecting a listening mode (Surround mode)**  [page 18](#)

For speaker connections, see [page 23](#),  page 2 "Connecting the speakers".

# Connections

## Important information

Make connections before using this unit.

To create a home theater that can play back higher quality video and audio by fully utilizing the capabilities of the unit and your video devices, connect the unit to each of your video devices with HDMI cables.

### □ HDMI-compatible device

If your video device does not support HDMI connections, use the following connection.

### □ HDMI-incompatible device

This unit can change the source that is assigned to the DIGITAL AUDIO IN connectors.

You can change the source for connectors listed in **Input connector setting** within pages that describe connections for devices.

For details on assigning a source to connectors, see “Changing the source assigned to connectors” (☞ [page 9](#)). For the setting method, see “Input Assign” (☞ [page 30](#)).

#### NOTE

- The menu screen is only displayed on TV connected to this unit via HDMI. If your TV is connected to this unit via other video output connectors, perform menu operations while seeing the display on this unit.
- Do not plug in the power cord until all connections have been completed.
- When making connections, also refer to the operating instructions of the other devices being connected.
- Be sure to connect the left and right channels properly (left with left, right with right).
- Do not bundle power cords together with connection cables. Doing so can result in noise.

### □ HDMI-compatible device

 <a href="#">page 6</a>	 <a href="#">page 7</a>	 <a href="#">page 7</a>
 <a href="#">page 7</a>	 <a href="#">page 7</a>	 <a href="#">page 7</a>

### □ HDMI-incompatible device

 <a href="#">page 10</a>	 <a href="#">page 11</a>	 <a href="#">page 12</a>
 <a href="#">page 12</a>	 <a href="#">page 13</a>	 <a href="#">page 13</a>

## Relationship between video signals and monitor output

This unit is equipped with two types of video input connectors (HDMI and video) and two types of video output connectors (HDMI and video).

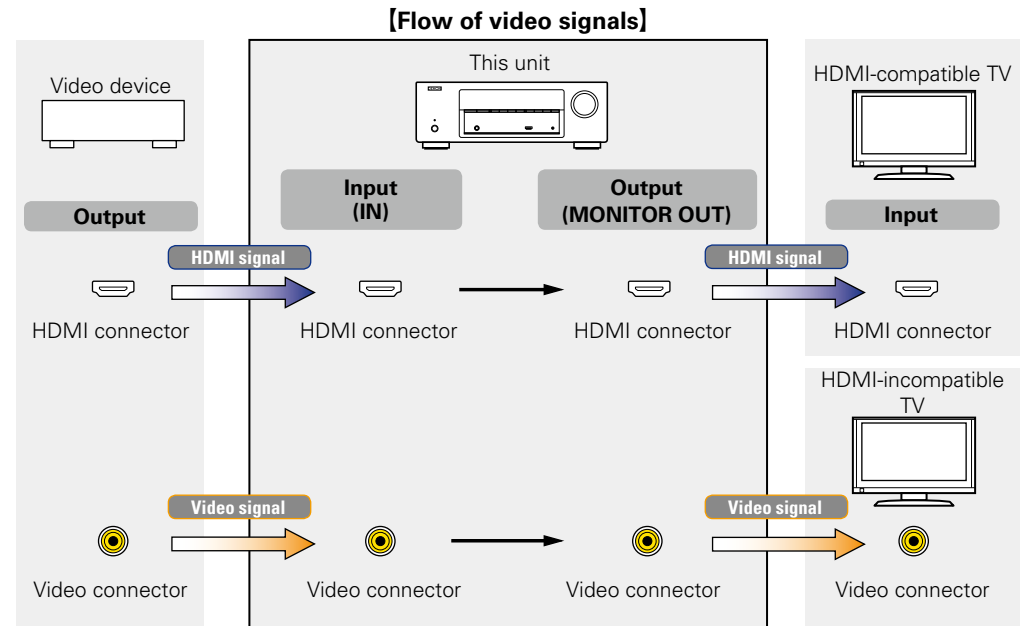

#### NOTE

- The menu screen is only displayed on TV connected to this unit via HDMI. If your TV is connected to this unit via other video output connectors, perform menu operations while seeing the display on this unit.
- HDMI signals cannot be converted into analog signals (☞ [page 49](#)).
- Analog signals cannot be converted into HDMI signals (☞ [page 49](#)).

## Examples of screen display

- SETUP MENU screen

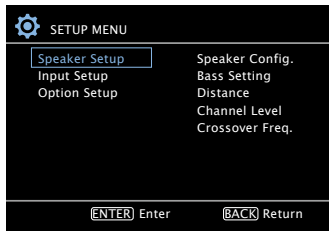

- Status display screen  
When the input source is switched.



- When the volume is adjusted.

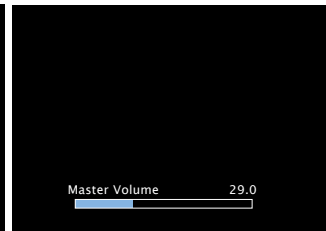

Status display: The operating status appears briefly on the screen when the input source is switched or the volume is changed.

### NOTE

- **The menu screen is only displayed on TV connected to this unit via HDMI. If your TV is connected to this unit via other video output connectors, perform menu operations while seeing the display on this unit.**
- If you operate the menu while playing back 3D video content or computer's resolution (e.g. VGA), the playback video is replaced by the menu screen. The playback video is not displayed behind the menu screen.
- This unit does not show the status display while playing back 3D video content or computer's resolution (e.g. VGA).

## Connecting an HDMI-compatible device

You can connect up to five HDMI-compatible devices (4-inputs/1-output) to the unit.

If the device connected to this unit is equipped with an HDMI connector, it is recommended to use HDMI connections. Connections with an HDMI cable offer the following benefits that can not be achieved with other connection methods.

### • High quality playback by transmitting audio and video via digital signals

HDMI connections can transmit high definition video and high quality audio formats adopted by Blu-ray disc players (Dolby Digital Plus, Dolby TrueHD, DTS-HD, DTS-HD Master Audio). HDMI connections also convey information required for playback between devices. This information is used for copyright protection and TV resolution recognition.

### • Transmission of audio and video signals with a single HDMI cable

Previous connections require multiple audio and video cables, but HDMI connections require only a single HDMI cable to transmit audio and video signals. This allows wires in a home theater system, which tend to be complicated, to be more organized.

### • Standby Pass ([page 33](#))

Outputs signals received from the HDMI input connector to the TV connected to the HDMI output connector even when the unit is in standby mode.

### • This unit also supports 3D video playback and other functions related to video and audio ([page 8](#)).



- There is more than one version of HDMI standard. The supported functions and the performance vary according to the version. This unit complies with the HDMI standard, supporting the 3D playback function. To enjoy these functions, the HDMI device connected to this unit also needs to use the same version of the standard. For the version of the HDMI standard on the device connected to this unit, see the device's manual.
- Some TVs do not support audio input via HDMI connections. For details, see your TV's manual.
- When "Standby Pass" is set to other than "OFF", more power is consumed than in normal standby mode.

❑ **Connecting this unit to a TV via HDMI connections** ([page 6](#))

❑ **Connecting this unit to video devices via HDMI connections** ([page 7](#))

❑ **HDMI function** ([page 8](#))

❑ **Settings related to HDMI connections** ([page 8](#))



## Connecting this unit to a TV via HDMI connections

### Cables used for connections

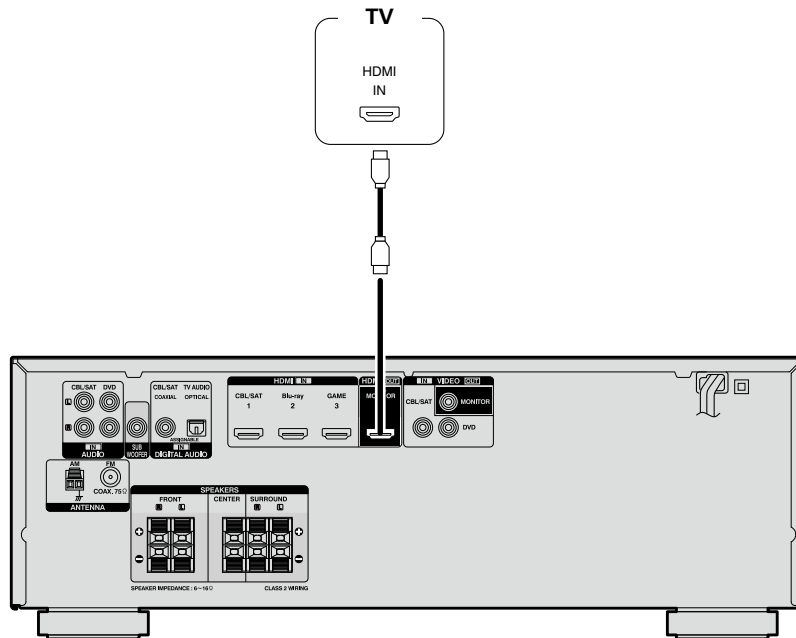
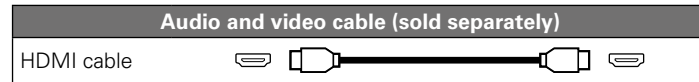

- Video signals are not output if the input video signals do not match the monitor's resolution. In this case, switch the Blu-ray Disc/DVD player's resolution to a resolution with which the monitor is compatible.
- When this unit and monitor are connected with an HDMI cable, if the monitor is not compatible with HDMI audio signal playback, only the video signals are output to the monitor. Make audio connections ([page 10](#) "Connecting a TV").

#### NOTE

- The audio signal from the HDMI output connector (sampling frequency, number of channels, etc.) may be limited by the HDMI audio specifications of the connected device regarding permissible inputs.
- Only an HDMI signal is output from the HDMI MONITOR OUT connector.

### Connecting to a device equipped with a DVI-D connector

The DVI-D (Digital Visual Interface) method is also used for video transmission via digital signals. This is developed mainly for computers, and some AV devices such as projectors are equipped with this interface. To output HDMI video signals to a DVI-D video input compatible device, use an HDMI/DVI conversion cable, which converts HDMI video signals to DVI signals.

The DVI-D connector can transmit high quality digital signals, but the copy guard and other issues may hinder normal operations for some device combinations.

#### NOTE

- No sound is output when connected to a device equipped with a DVI-D connector. Make audio connections as described in "Connecting a TV" ([page 10](#)).
- Signals cannot be output to DVI-D devices that do not support HDCP.
- Depending on the combination of devices, the video signals may not be output.

## Connecting this unit to video devices via HDMI connections

### Cables used for connections

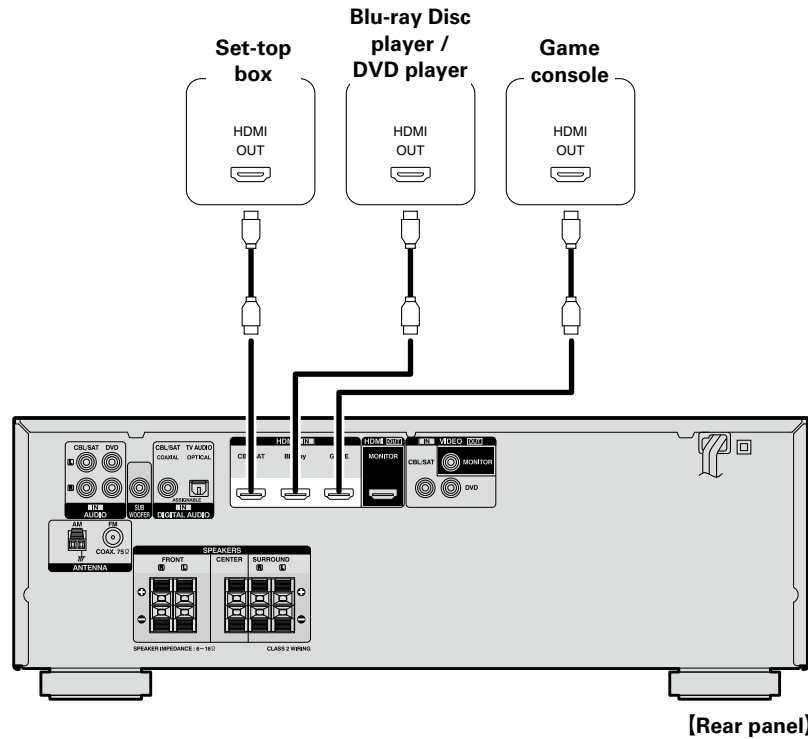
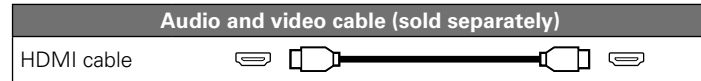

- When this unit is connected to other devices with HDMI cables, connect this unit and TV also with an HDMI cable.
- When connecting a device that supports Deep Color, please use a “High Speed HDMI cable” or “High Speed HDMI cable with Ethernet”.

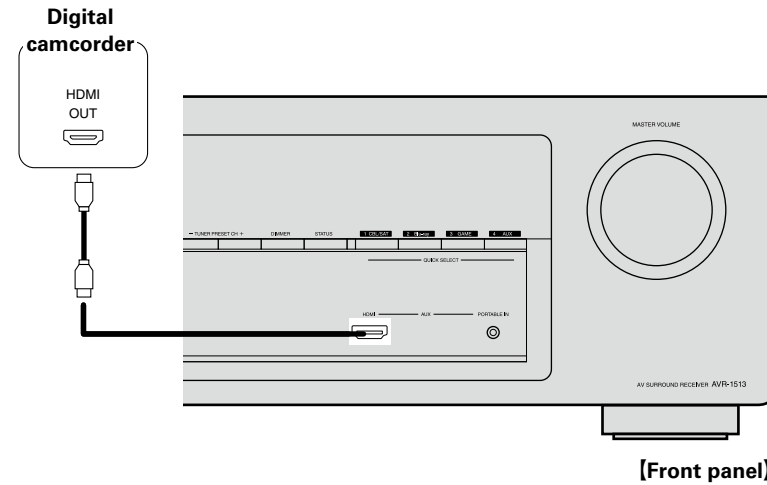

- When playback devices are connected to the AUX HDMI connector and the AUX PORTABLE IN jack on the front panel, priority is given to the device connected to the AUX HDMI connector.
- You can enjoy games by connecting a game machine via the AUX HDMI connector. In this case, select the input source to “AUX”.

## HDMI function

This unit supports the following HDMI functions:

### □ About 3D function

This unit supports input and output of 3D (3 dimensional) video signals of HDMI.

To play back 3D video, you need a TV and player that provide support for the HDMI 3D function and a pair of 3D glasses.

#### NOTE

- When playing back 3D video, refer to the instructions provided in the manual of your playback device together with this manual.
- If you operate the menu while playing back 3D video content, the playback video is replaced by the menu screen. The playback video is not displayed behind the menu screen.
- This unit does not show the status display while playing back 3D video content.
- If 3D video with no 3D information is input, the menu screen and status display on this unit are displayed over the playback video.
- If 2D video is converted to 3D video on the television, the menu screen and status display on this unit are not displayed correctly. To view the menu screen and status display on this unit correctly, turn the television setting that converts 2D video to 3D video off.

### □ Deep Color (👉 page 50)

When a device supporting Deep Color is connected, use a cable compatible with “High Speed HDMI cable” or “High Speed HDMI cable with Ethernet”.

### □ “x.v.Color”, sYCC601 color, Adobe RGB color, Adobe YCC601 color (👉 page 50, 51)

### □ High definition digital audio format

#### Copyright protection system

In order to play back digital video and audio such as BD-Video or DVD-Video via HDMI connection, both this unit and TV or the player need to support the copyright protection system known as HDCP (High-bandwidth Digital Content Protection System). HDCP is copyright protection technology comprised of data encryption and authentication of the connected AV devices. This unit supports HDCP.

- If a device that does not support HDCP is connected, video and audio are not output correctly. Read the owner’s manual of your television or player for more information.

## Settings related to HDMI connections

Set as necessary. For details, see the respective reference pages.

### □ HDMI (👉 page 33)

Make settings for HDMI.

- HDMI Audio Out
- Standby Pass

#### NOTE

The audio signal input from the HDMI input connector can be output as an output signal from the HDMI output connector by setting the HDMI audio output destination to TV.













Audio signals input via the Analog/Coaxial/Optical input connectors cannot be output from the HDMI output connector.

## Connecting an HDMI-incompatible device





For high quality video and surround playback, it is recommended to use an HDMI cable to connect this unit to TV and other video devices (see [page 5](#) "Connecting an HDMI-compatible device").

This section describes connections when your device does not support HDMI connections.

### Connection methods for various devices

 TV	 <a href="#">page 10</a>	 CBL/SAT	 <a href="#">page 11</a>
 Blu-ray	 <a href="#">page 12</a>	 DVD	 <a href="#">page 12</a>
 AUX	 <a href="#">page 13</a>	 TUNER	 <a href="#">page 13</a>

### Cables used for connections

Video cable (sold separately)	
Video cable	
Audio cable (sold separately)	
Coaxial digital cable	
Optical cable	
Audio cable	
Stereo mini plug cable	

### Changing the source assigned to connectors

This unit can change the source that is assigned to the DIGITAL AUDIO IN connectors.

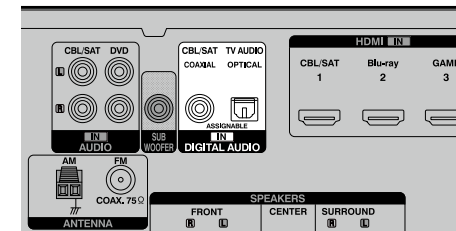

Here, a connection to the DVD player is taken as an example for explanation. The rear panel digital audio input connectors do not have the input connector indication for DVD players (DVD). However, DIGITAL AUDIO IN connectors have the "ASSIGNABLE" indication, which means that you can change the source assigned to these connectors. You can assign DVD players to these connectors to use them for DVD players. If you select "DVD" when you switch the input source for this unit, you can play back the source connected to these connectors.

#### How to change the source assigned to connectors ([page 30](#))

## Connecting a TV

- This section describes how to connect when your TV does not support HDMI connections.  
For instructions on HDMI connections, see “Connecting an HDMI-compatible device” ([page 5](#)).
- To listen to TV audio through this device, use the optical digital connection.

### Audio connection

The following methods are available for connecting to this unit. **Use either of the methods to make a connection.**

The numbers prefixed with connectors indicate the recommendation order. The smaller the number is, the higher playback quality is achieved.

#### 1 DIGITAL AUDIO COAXIAL connector \* DIGITAL AUDIO OPTICAL connector

When a multichannel audio (digital bit stream audio) is input, this unit decodes the audio to play back surround sound.

\*: When making this type of connection, you must change the settings on this unit.

([Input connector setting](#))

### Video connection

The following methods are available for connecting to this unit.

#### 1 VIDEO OUT (MONITOR) connector

This makes an analog video connection.

#### Input connector setting

When making the following connection, you must change the input connector settings.

#### 1 DIGITAL AUDIO COAXIAL connector

Change the default “CBL/SAT” to “TV AUDIO”.

For how to change, see “Input Assign” ([page 30](#)).

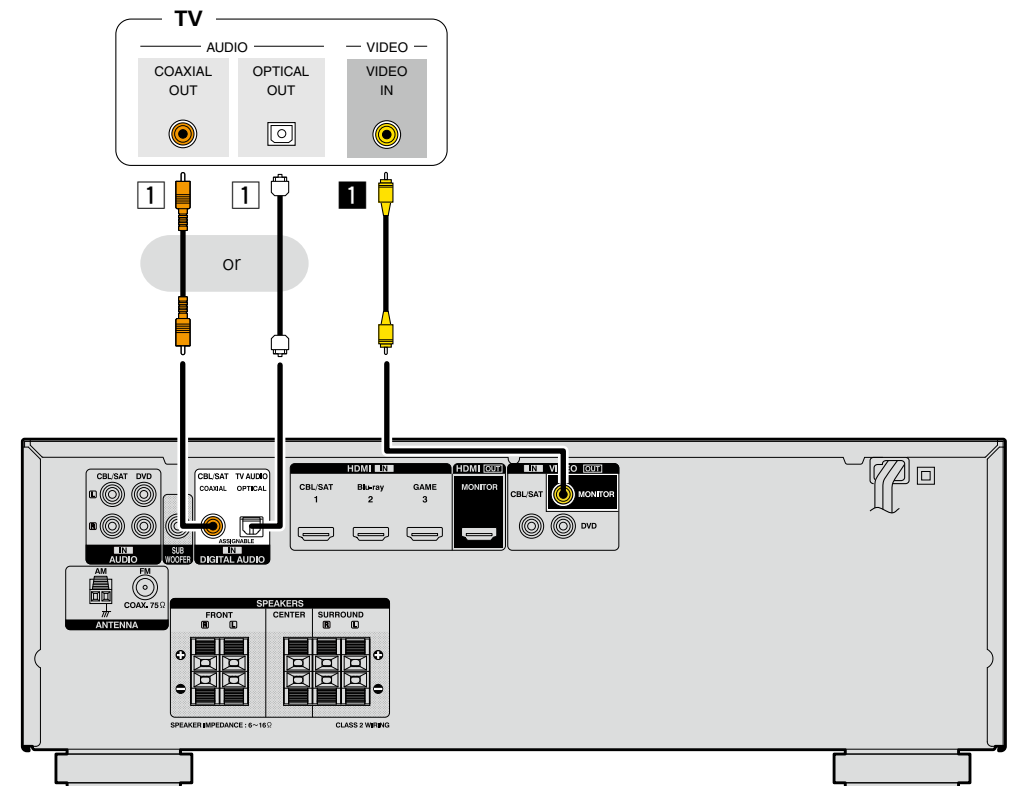

#### NOTE

- The menu screen is only displayed on TV connected to this unit via HDMI. If your TV is connected to this unit via other video output connectors, perform menu operations while seeing the display on this unit.
- If the VIDEO input connector is to be used, be sure to connect the MONITOR output connector of the unit and the VIDEO input connector of the TV, using a video cable.

## Connecting a set-top box (Satellite tuner/Cable TV)

This section describes how to connect when your satellite tuner or cable TV does not support HDMI connections.

For instructions on HDMI connections, see “Connecting an HDMI-compatible device” ([page 5](#)).

### Audio connection

The following methods are available for connecting to this unit. **Use either of the methods to make a connection.**

The numbers prefixed with connectors indicate the recommendation order. The smaller the number is, the higher playback quality is achieved.

#### 1 DIGITAL AUDIO COAXIAL connector DIGITAL AUDIO OPTICAL connector \*

When a multichannel audio (digital bit stream audio) is input, this unit decodes the audio to play back surround sound.

\*: When making this type of connection, you must change the settings on this unit.

([Input connector setting](#))

#### 2 AUDIO IN (CBL/SAT) connector

This makes an analog audio connection. This type of connection converts digital audio to analog audio, so the output audio may be degraded compared to connections 1.

### Video connection

The following methods are available for connecting to this unit.

#### 1 VIDEO IN (CBL/SAT) connector

This makes an analog video connection.

#### Input connector setting

When making the following connection, you must change the input connector settings.

#### 1 DIGITAL AUDIO OPTICAL connector

Change the default “TV AUDIO” to “CBL/SAT”.

For how to change, see “Input Assign” ([page 30](#)).

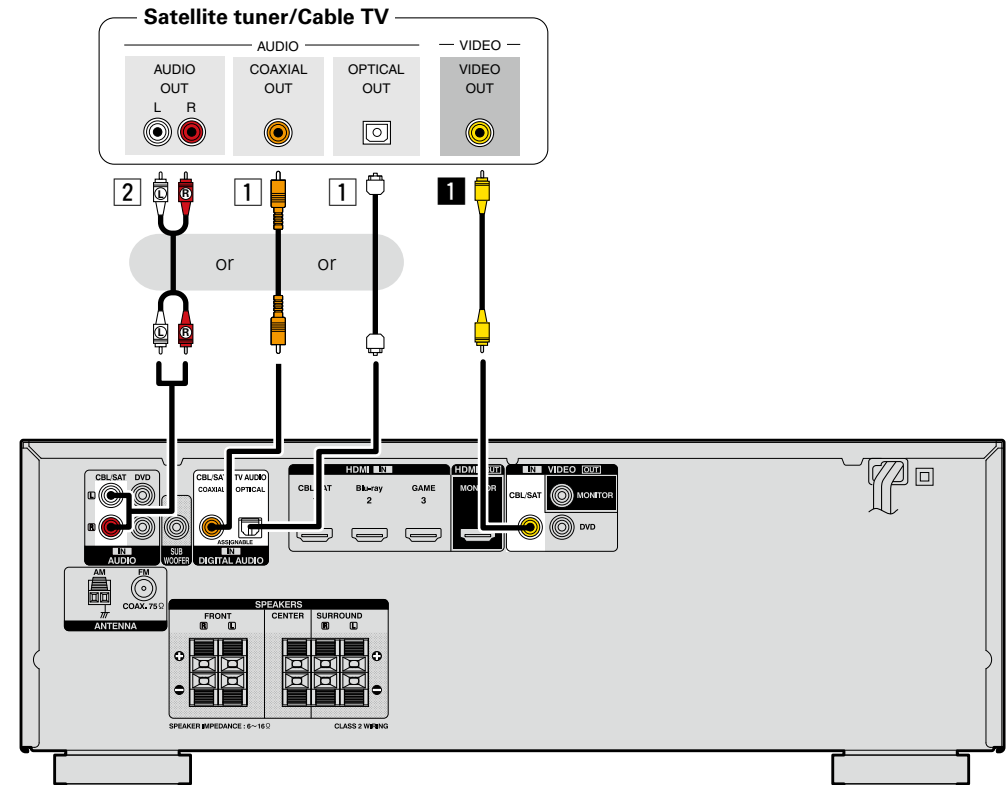

## Connecting a Blu-ray Disc player/DVD player

This section describes how to connect when your Blu-ray Disc player and DVD player do not support HDMI connections.

For instructions on HDMI connections, see “Connecting an HDMI-compatible device” ([page 5](#)).

### Audio connection

The following methods are available for connecting to this unit. **Use either of the methods to make a connection.**

The numbers prefixed with connectors indicate the recommendation order. The smaller the number is, the higher playback quality is achieved.

#### 1 DIGITAL AUDIO COAXIAL connector DIGITAL AUDIO OPTICAL connector

When a multichannel audio (digital bit stream audio) is input, this unit decodes the audio to play back surround sound. However, digital bit stream audio signals for HD audios from Blu-ray disc players (such as Dolby Digital Plus and DTS-HD) can not be transmitted.

When making this type of connection, you must change the settings on this unit.

[Input connector setting](#)

#### 2 AUDIO IN (DVD) connector

This makes an analog audio connection. This type of connection converts digital audio to analog audio, so the output audio may be degraded compared to connections [1](#).

### Video connection

The following methods are available for connecting to this unit.

#### 1 VIDEO IN (DVD) connector

This makes an analog video connection.

#### Input connector setting

When making the following connection, you must change the input connector settings.

##### 1 DIGITAL AUDIO COAXIAL connector

Change the default “CBL/SAT” to “DVD”.

##### DIGITAL AUDIO OPTICAL connector

Change the default “TV AUDIO” to “DVD”.

For how to change, see “Input Assign” ([page 30](#)).

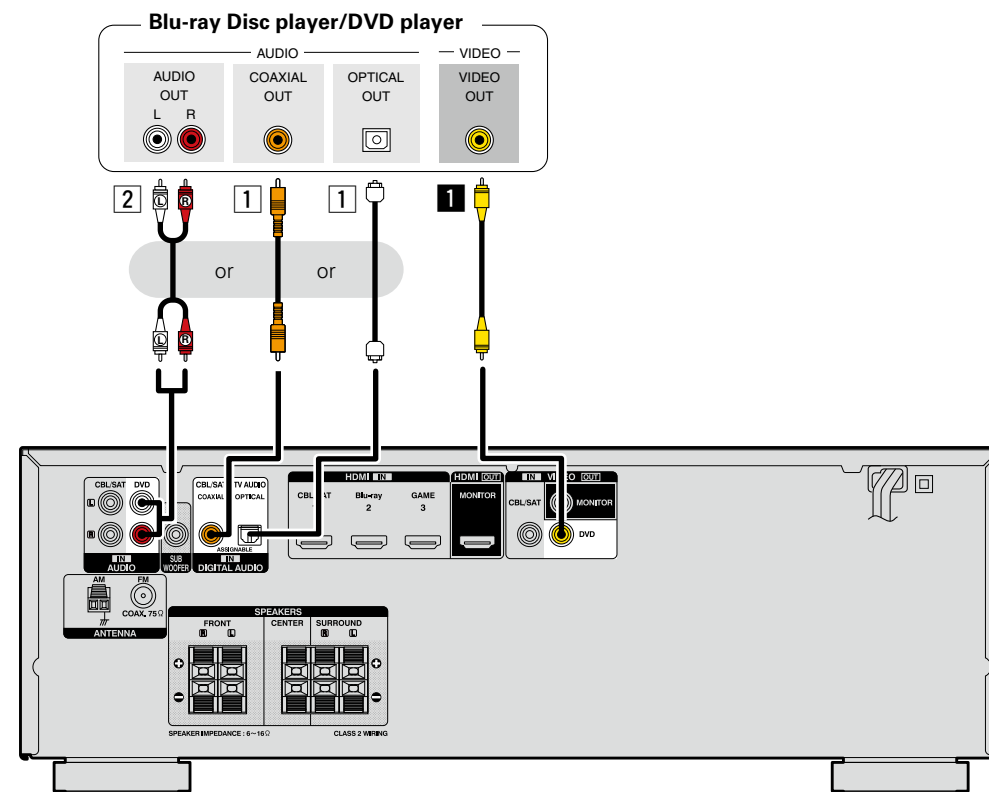

When you want to play back HD Audio (Dolby TrueHD, DTS-HD, Dolby Digital Plus, DTS Express) and Multi-channel PCM with this unit, use an HDMI connection ([page 5](#) “Connecting an HDMI-compatible device”).

## Connecting a portable player

If a portable player is connected via the AUX PORTABLE IN jack of the unit, music from the portable player can be played.

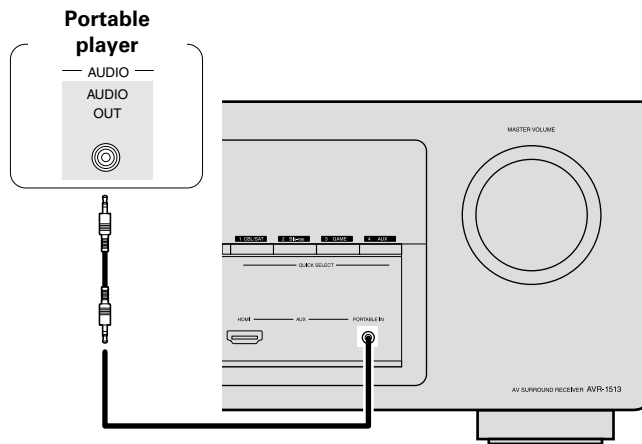

### NOTE

When playback devices are connected to the AUX HDMI connector and the AUX PORTABLE IN jack on the front panel, priority is given to the device connected to the AUX HDMI connector.

If you prefer to play back the device connected to the AUX PORTABLE IN jack, then either disconnect the HDMI cable or change the "Input Mode" ([page 31](#)) setting to "Analog".

## Connecting an antenna

- Connect the FM antenna or AM loop antenna supplied with the unit to enjoy listening to radio broadcasts.
- After connecting the antenna and receiving a broadcast signal ([page 16](#) "Listening to FM/AM broadcasts"), fix the antenna with tape in a position where the noise level becomes minimal.

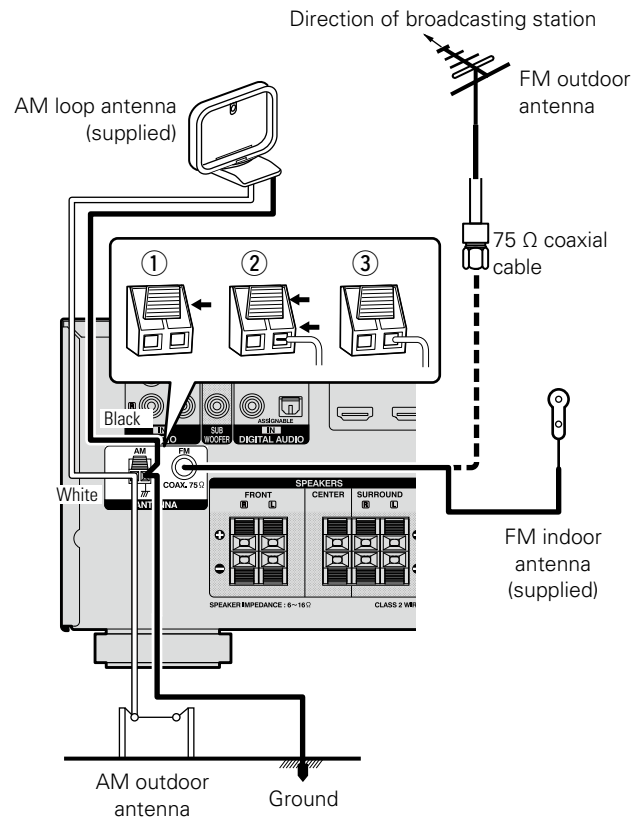

### AM loop antenna assembly

- 1 Put the stand section through the bottom of the loop antenna from the rear and bend it forward.
- 2 Insert the projecting part into the square hole in the stand.

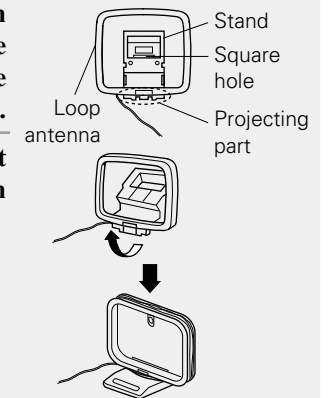

### Using the AM loop antenna

#### Suspending on a wall

Suspend directly on a wall without assembling.

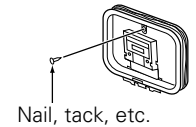

#### Standing alone

Use the procedure shown above to assemble.

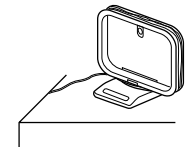

### NOTE

- Do not connect two FM antennas simultaneously.
- Even if an external AM antenna is used, do not disconnect the AM loop antenna.
- Make sure the AM loop antenna lead terminals do not touch metal parts of the panel.
- If the signal has noise interference, connect the ground terminal (GND) to reduce noise.
- If you are unable to receive a good broadcast signal, we recommend installing an outdoor antenna. For details, inquire at the retail store where you purchased the unit.



# Playback (Basic operation)

- ❑ **Selecting the input source** (👉 page 14)
- ❑ **Adjusting the master volume** (👉 page 14)
- ❑ **Turning off the sound temporarily** (👉 page 14)
- ❑ **Switching the brightness of the display** (👉 page 15)

- ❑ **Playing a Blu-ray Disc player/DVD player** (👉 page 15)
- ❑ **Playing a portable player** (👉 page 15)
- ❑ **Tuning in radio stations** (👉 page 16)

**Selecting a listening mode (Surround mode)**  
(👉 page 18)

**Playback (Advanced operation)** (👉 page 25)

## Important information

Before starting playback, make the connections between the different devices and the settings on the unit.

### NOTE

Also refer to the operating instructions of the connected devices when playing them.

## Selecting the input source

Press the input source select button (**CBL/SAT, DVD, Blu-ray, GAME, AUX, TV AUDIO or TUNER**) to be played back.

The desired input source can be selected directly.

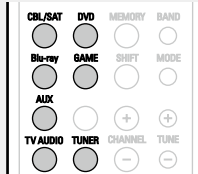

You can also use the following operation to select an input source.

### ❑ Using the button on the main unit

Use **SOURCE** ◀▶.

- Use **SOURCE** ◀▶ switches the input source, as shown below.

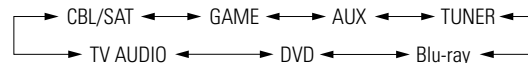

## Adjusting the master volume

Use **VOLUME** ▲▼ to adjust the volume.

### ❑ When the “Scale” setting (👉 page 32) is “Absolute”

**[Adjustable range] 0.0 – 98.0**

- The variable range differs according to the input signal and channel level setting.

### ❑ When the “Scale” setting (👉 page 32) is “Relative”

**[Adjustable range] --- –79.5dB – 18.0dB**

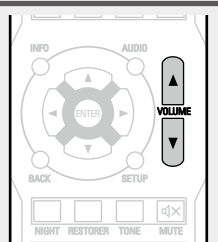

You can also operate via the main unit. In this case, perform the following operations.

Turn **MASTER VOLUME** to adjust the volume.

## Turning off the sound temporarily

Press **MUTE** ◻X.

- “MUTE” indicator on the display flashes.
- ◻X appears on a TV screen.



- The sound is reduced to the level set at “Mute Level” (👉 page 32).
- To cancel, press **MUTE** ◻X again. Muting can also be canceled by adjusting the master volume.

## Switching the brightness of the display

### Press DIMMER.

- The display brightness of this unit switches each time the button is pressed.

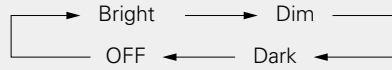

- |               |                              |
|---------------|------------------------------|
| <b>Bright</b> | Normal display brightness.   |
| <b>Dim</b>    | Reduced display brightness.  |
| <b>Dark</b>   | Very low display brightness. |
| <b>OFF</b>    | Turns the display off.       |

### NOTE

When the brightness of the display is set to "OFF", the display turns off and appears as if there is no electricity.

## Playing a Blu-ray Disc player/DVD player

The following describes the procedure for playing Blu-ray Disc player/DVD player.

### 1 Prepare for playback.

- ① Turn on the power of the TV, subwoofer and player.
- ② Change the TV input to the input of this unit.
- ③ Load the disc in the player.

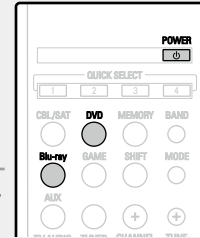

### 2 Press POWER to turn on power to the unit.

### 3 Press Blu-ray or DVD to switch an input source for a player used for playback.

### 4 Play the device connected to this unit.

- Make the necessary settings on the player (language setting, subtitles setting, etc.) beforehand.

## Playing a portable player

The following describes the procedure for playing portable player.

### 1 Connect the portable player to this unit (see page 13 "Connecting a portable player").

### 2 Press POWER to turn on power to the unit.

### 3 Press AUX to switch the input source to "AUX".

### 4 Play the component connected to this unit.

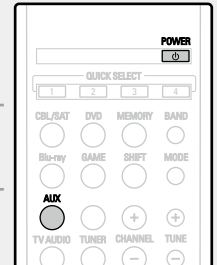

### NOTE

When playback devices are connected to the AUX HDMI connector and the AUX PORTABLE IN jack on the front panel, priority is given to the device connected to the AUX HDMI connector.

If you prefer to play back the device connected to the AUX PORTABLE IN jack, then either disconnect the HDMI cable or change the "Input Mode" (see page 31) setting to "Analog".

## Tuning in radio stations

For antenna connections, see “Connecting an antenna” (page 13).

### Listening to FM/AM broadcasts

The modes for receiving FM/AM broadcasts consists of “AUTO” mode that automatically searches available broadcast stations and “MANUAL” mode that lets you tune in using buttons to change the frequency. The default setting is “AUTO”.

In “AUTO” mode, you cannot tune in to radio stations if the reception is not good. If this is the case, then use the “MANUAL” to tune in.

**1** Press **TUNER** to switch the input source to “TUNER”.

**2** Press **BAND** to select “FM” or “AM”.

**FM** When listening to an FM broadcast.

**AM** When listening to an AM broadcast.

[TV Screen]

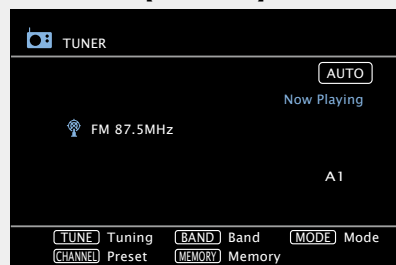

[Display of this unit]

A1 FM 87.50MHz



### 3 Tune in the desired broadcast station.

**AUTO** Automatically tune to the station.

① Press **MODE** to select “AUTO”.

MODE: AUTO

② Press **TUNE +** or **TUNE –** to select the station you want to hear.

**MANUAL** Manually tune to the station.

① Press **MODE** to select “MANUAL”.

MODE: MANUAL

② Press **TUNE +** or **TUNE –** to select the station you want to hear.



When tuning in stations manually, press and hold **TUNE +** or **TUNE –** to change frequencies continuously.

### Presetting radio stations (Manual preset)

Your favorite broadcast stations can be preset so that you can tune them in easily. Up to 56 stations can be preset.

- Stations can be preset automatically at “Auto Preset” (page 31). If “Auto Preset” is performed after performing “Manual preset”, the “Manual preset” settings will be overwritten.

**1** Tune in the broadcast station you want to preset.

**2** Press **MEMORY**.

[TV Screen]

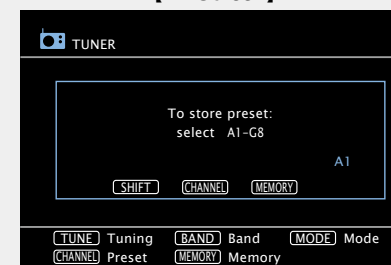

[Display of this unit]

Storing Station



**3** Press **CHANNEL +** or **CHANNEL –** to select the preset number.

- Press **SHIFT**, and then the block (A – G) can be selected.

**4** Press **MEMORY** again to complete the setting.

- To preset other stations, repeat steps 1 to 4.

### Default settings

Block (A – G) and Channel (1 – 8)	Default Settings
A1 – A8	87.5 / 89.1 / 98.1 / 107.9 / 90.1 / 90.1 / 90.1 / 90.1 MHz
B1 – B8	520 / 600 / 1000 / 1400 / 1500 / 1710 kHz, 90.1 / 90.1 MHz
C1 – C8	90.1 MHz
D1 – D8	90.1 MHz
E1 – E8	90.1 MHz
F1 – F8	90.1 MHz
G1 – G8	90.1 MHz

### Listening to preset stations

**1** Press **SHIFT** to select the memory block (A to G).

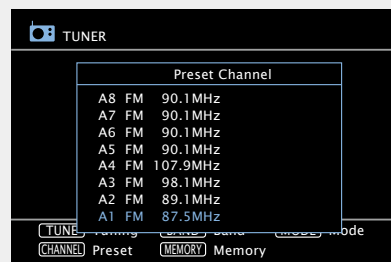

**2** Press **CHANNEL +** or **CHANNEL –** to select the desired preset channel.



You can also operate via the main unit. In this case, perform the following operations.  
Press **TUNER PRESET CH +** or **TUNER PRESET CH –** to select a preset radio station.

### Tuner (FM/AM) operation buttons

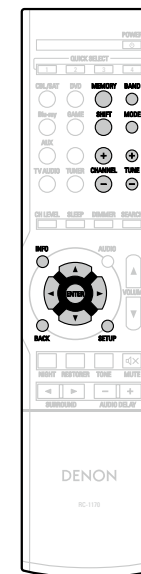

Operation buttons	Function
<b>MEMORY</b>	Preset memory registration
<b>BAND</b>	FM/AM switching
<b>SHIFT</b>	Preset channel block selection
<b>MODE</b>	Switch search modes
<b>CHANNEL +, –</b>	Preset channel selection
<b>TUNE +, –</b>	Tuning (up/down)
<b>INFO</b>	Display of information such as the source name, volume, and surround mode name
△▽◀▶	Cursor operation
<b>ENTER</b>	Enter
<b>BACK</b>	Return
<b>SETUP</b>	Setup menu

# Selecting a listening mode (Surround mode)

This unit can play input audio signals in multi-channel surround mode or in stereo mode.

You can set various surround modes based on the audio input signal from the playback source. Try out different surround modes based on the content you play back and find your favorite surround mode.

## Listening Mode

Input audio signal	Playback	Listening mode	
2-channel → Multi channel →	Surround →	<b>Standard playback</b> (page 19)	For 2-channel signal input: • Surround-channel signals are created and played with surround playback. For multichannel signal input: • The surround signal recorded in source is played as surround playback. (The sound is played according to the settings of the speaker size in page 5 "Speaker Config.")
2-channel → Multi channel →	Surround →	<b>Multi channel stereo playback</b> (page 20)	This mode is for enjoying stereo sound from all speakers.
2-channel → Multi channel →	Surround →	<b>Virtual playback</b> (page 20)	This mode is for enjoying surround effects using only the front speakers or headphones.
2-channel → Multi channel →	Stereo →	<b>Stereo playback</b> (page 20)	• If multichannel signals are input, they are mixed down to 2-channel audio and are played. • Subwoofer signals are also output.
2-channel → Multi channel →	Stereo → Surround →	<b>Direct playback</b> (page 20)	Sound recorded in source is played as is. • In this mode, the following items cannot be adjusted. • Tone (page 36)                      • RESTORER (page 37)



- Some listening modes cannot be selected, depending on the audio format or number of channels of the input signal. For details, see "Types of input signals, and corresponding surround modes" (page 48).
- Adjust the sound field effect with the menu "Audio Adjust" (page 34) to enjoy your favorite sound mode.
- Buttons on the remote control unit can be used for operations. Press **SURROUND** ◀ or **SURROUND** ▶ and the modes are switched as shown below.

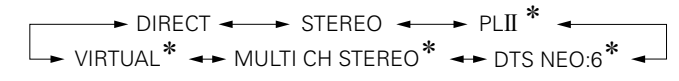
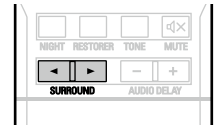

\* The display varies depending on the audio format or the number of channels of input signals.

# Standard playback

## Surround playback of 2-channel sources

**1** Play the selected device (🔗 [page 15, 16](#)).

**2** Press **SURROUND** ◀ or **SURROUND** ▶ to select the surround decoder to play back multichannel sound.

Select the surround mode while viewing the display on the TV screen.

- Which decoder can be selected depends on the settings of 📖 [page 5](#) "Speaker Config."

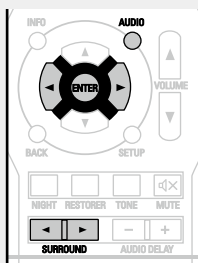

- DOLBY PLII** This mode is for 5.1-channel surround playback.
  - "PLII Cinema", "PLII Music", "PLII Game" or "Pro Logic" is displayed.
- DTS NEO:6** This mode is for 5.1-channel surround playback.
  - "DTS NEO:6 Cinema" or "DTS NEO:6 Music" is displayed.

**3** Press **AUDIO** and then press **ENTER**.

**4** Use ◀ ▶ to select the mode according to the content to be played and then press **ENTER**.



- Cinema** This mode is suited for movie sources.
- Music** This mode is suited for music sources. More sound is sent to the front speakers than in "Cinema" mode.
- Game** This mode is suited for games.
- Pro Logic** This mode is suitable for playback of 2-channel sources recorded with Dolby Pro Logic.

**5** Press **AUDIO**.  
The menu display disappears.

## Surround playback of multi-channel sources (Dolby Digital, DTS etc.)

**1** Play the selected device (🔗 [page 15, 16](#)).

**2** Press **SURROUND** ◀ or **SURROUND** ▶ to select the surround decoder to play back multichannel sound.

Select the surround mode while viewing the display on the TV screen.

- Which decoder can be selected depends on the input signal, the settings of 📖 [page 5](#) "Speaker Config."

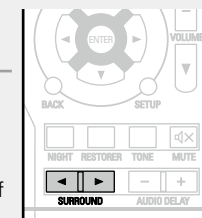

### Displaying the currently playing surround mode

Input signal	Surround mode
DOLBY DIGITAL (other than 2ch)	DOLBY DIGITAL
DOLBY DIGITAL Plus	DOLBY DIGITAL Plus
DOLBY TrueHD	DOLBY TrueHD
DTS (5.1ch) / DTS 96/24	DTS SURROUND
	DTS 96/24*
DTS-HD	DTS-HD HI RES
	DTS-HD MSTR
	DTS Express
PCM (multi ch)	MULTI CH IN

\* This is displayed when the input signal is "DTS 96/24".

### Views on the display

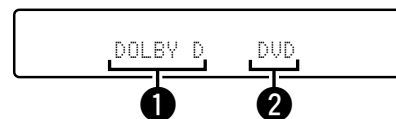

- 1** Shows a decoder to be used.
  - A DOLBY DIGITAL decoder is displayed as "DOLBY D".
  - A DOLBY DIGITAL Plus decoder is displayed as "DOLBY D +".
- 2** Shows the name of the input source being played back.



For an input signal that can be reproduced in each surround mode, see "Surround modes and surround parameters" (🔗 [page 46](#)).

## Multi channel stereo playback

This mode is for enjoying stereo sound from all speakers.

**1** Play the selected device  
(☞ [page 15, 16](#)).

**2** Press **SURROUND** ◀ or  
**SURROUND** ▶ to select “MULTI  
CH STEREO”.

Multi channel stereo playback begins.

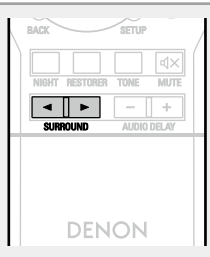

### NOTE

When the input signal is Dolby TrueHD, Dolby Digital Plus, DTS-HD or DTS Express, you cannot select multi channel stereo mode.

## Virtual playback

This mode is for enjoying surround effects using only the front speakers or headphones.

**1** Play the selected device  
(☞ [page 15, 16](#)).

**2** Press **SURROUND** ◀ or  
**SURROUND** ▶ to select  
“VIRTUAL”.

Virtual playback begins.

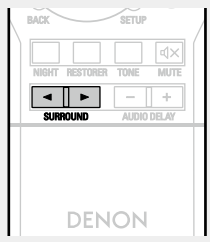

### NOTE

When the input signal is Dolby TrueHD, Dolby Digital Plus, DTS-HD or DTS Express, you cannot select virtual mode.

## Stereo playback

This is the mode for playing in stereo. The tone can be adjusted.

- Sound is output from the front left and right speakers and subwoofer.
- If multichannel signals are input, they are mixed down to 2-channel audio and are played.

**1** Play the selected device  
(☞ [page 15, 16](#)).

**2** Press **SURROUND** ◀ or  
**SURROUND** ▶ to select  
“STEREO”.

Stereo playback begins.

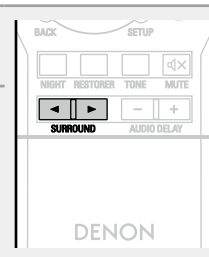

## Direct playback

Sound recorded in source is played as is.

- In this mode, the following items cannot be adjusted.
  - Tone (☞ [page 36](#))
  - RESTORER (☞ [page 37](#))

**1** Play the selected device  
(☞ [page 15, 16](#)).

**2** Press **SURROUND** ◀ or  
**SURROUND** ▶ to select  
“DIRECT”.

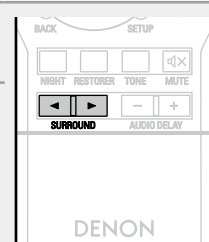

Direct playback begins.



## Advanced version

---

Here, we explain functions and operations that let you make better use of this unit.

- **Speaker installation/connection (Advanced connection)**  [page 22](#)
- **Playback (Advanced operation)**  [page 25](#)
- **How to make detailed settings**  [page 27](#)



# Speaker installation/connection (Advanced connection)

## Procedure for speaker settings

Speaker installation



Speaker connection (👉 page 23)

## Speaker installation

- Determine the speaker system depending on the number of speakers you are using and install each speaker and subwoofer in the room.
- Here, we explain how to install the speakers using a typical example.
- The speaker impedance should be from 6 to 16 Ω.



Use the illustration below as a guide for how high each speaker should be installed. The height does not need to be exactly the same.

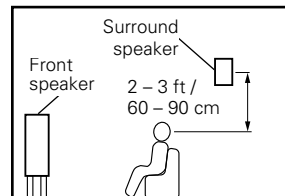

[Viewed from the side]

### When 5.1 ch speakers installed

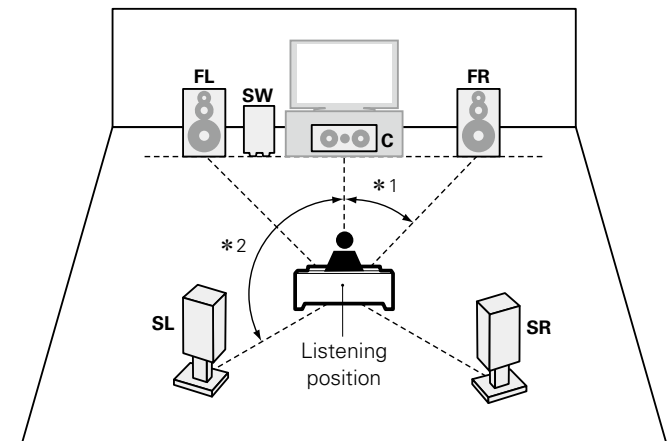

\*1 22° - 30° \*2 120°

### When 2.1 ch speakers installed

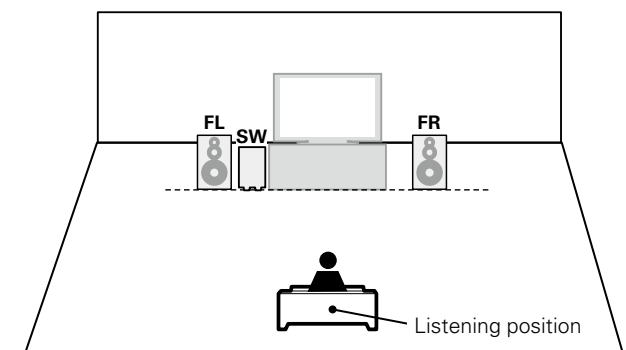

#### [Speaker abbreviations]

- |                             |                                |
|-----------------------------|--------------------------------|
| <b>FL</b> Front speaker (L) | <b>SL</b> Surround speaker (L) |
| <b>FR</b> Front speaker (R) | <b>SR</b> Surround speaker (R) |
| <b>C</b> Center speaker     |                                |
| <b>SW</b> Subwoofer         |                                |

## Speaker connection

Here, we connect the speakers in the room to this unit.

This section explains how to connect them using a typical example.

- For TV connections, see "Connecting this unit to a TV via HDMI connections" (page 6) or "Connecting a TV" (page 10).

❑ Connecting 5.1-channel speakers (page 23)

❑ Connecting 2.1-channel speakers (page 24)

### NOTE

- Disconnect this unit's power plug from the power outlet before connecting the speakers. Also, turn off the subwoofer.
- Connect so that the speaker cable core wires do not protrude from the speaker terminal. The protection circuit may be activated if the core wires touch the rear panel or if the + and - sides touch each other (page 51 "Protection Circuit").
- Never touch the speaker terminals while the power supply is connected. Doing so could result in electric shock.
- Use speakers with the speaker impedances shown below.

Speaker terminals	Speaker impedance
FRONT	6 – 16 Ω
CENTER	
SURROUND	

### Preparation

Carefully check the left (L) and right (R) channels and + (red) and - (black) polarities on the speakers being connected to the this unit, and be sure to interconnect the channels and polarities correctly.

#### Connecting the speaker cables

Peel off about 0.03 ft/10 mm of sheathing from the tip of the speaker cable, then either twist the core wire tightly or terminate it.

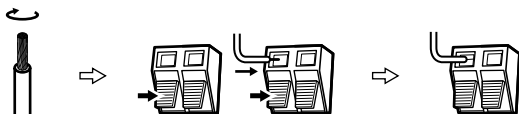

## Connecting 5.1-channel speakers

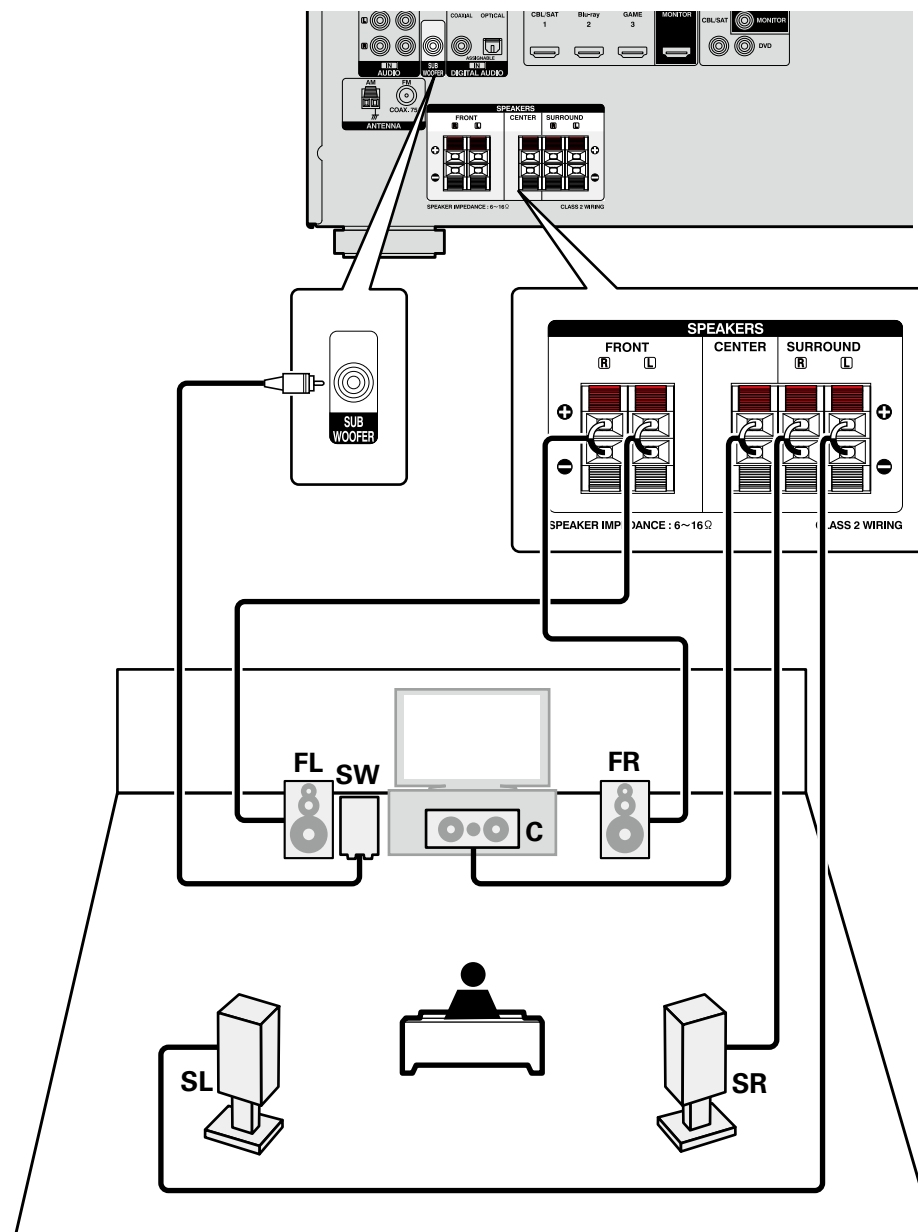

## Connecting 2.1-channel speakers

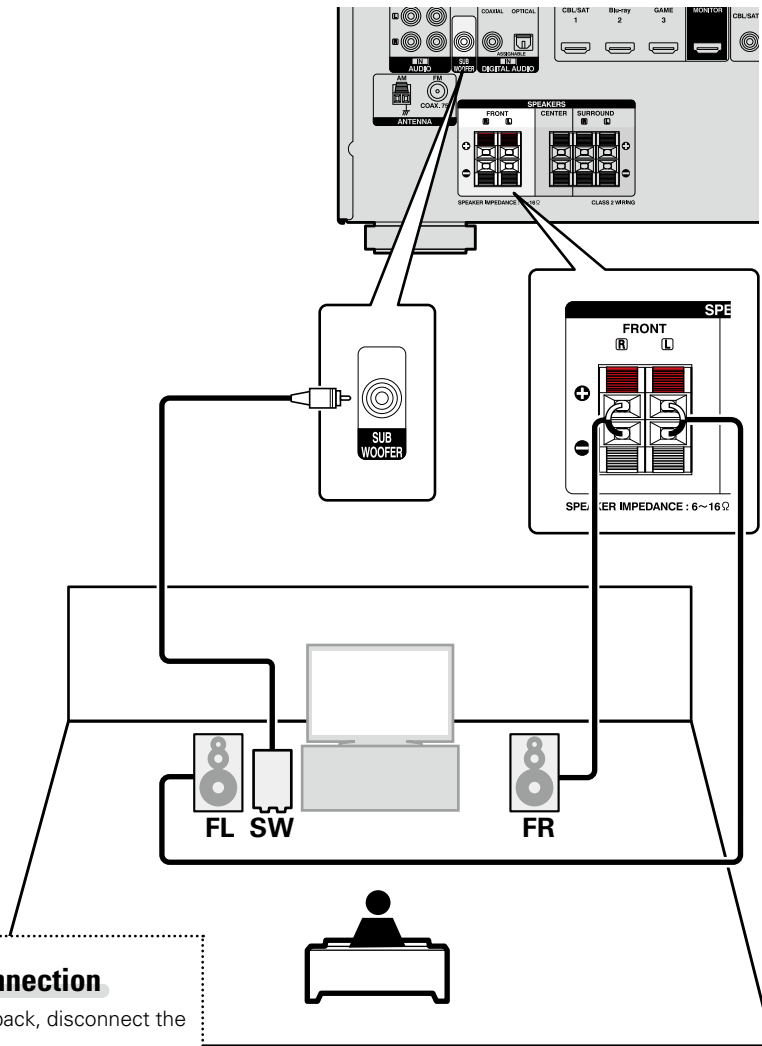

### 2-channel connection

For 2-channel playback, disconnect the subwoofers.

#### NOTE

- For speaker cable connections, see [page 23](#).
- For speaker impedance, see [page 23](#).

# Playback (Advanced operation)

Playback (Basic operation) (page 14)

Selecting a listening mode (Surround mode)  
(page 18)

Adjusting the volume of the speakers  
(page 25)

Sleep timer function (page 26)

Quick select function (page 26)

Various memory functions (page 26)

## Convenient functions

### Adjusting the volume of the speakers

You can adjust the channel level either according to the playback sources or to suit your taste, as described below.

#### Adjusting the volume of the different speakers

##### 1 Press CH LEVEL.

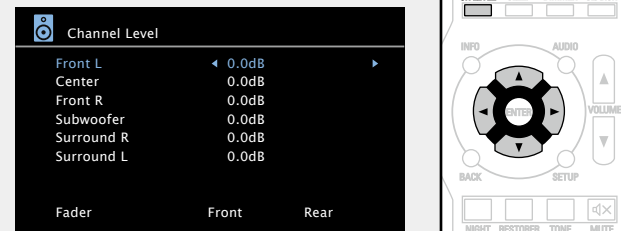

##### 2 Use $\Delta$ / $\nabla$ to select the speaker.

The speaker that can be set switches each time one of the buttons is pressed.

##### 3 Use $\triangleleft$ / $\triangleright$ to adjust the volume.

- In the case of a subwoofer, pressing  $\triangleleft$  when it is at “-12 dB” will change the setting to “OFF”.



- If you do not press any button for approximately 5 seconds, the menu screen light turns off.
- When a headphone jack is inserted, the headphone channel level can be adjusted.

#### Adjusting the volume of groups of speakers (Fader function)

This function lets you adjust (fade) the sound all at once from the front (front speaker / center speaker) or rear (surround speaker).

##### 1 Press CH LEVEL.

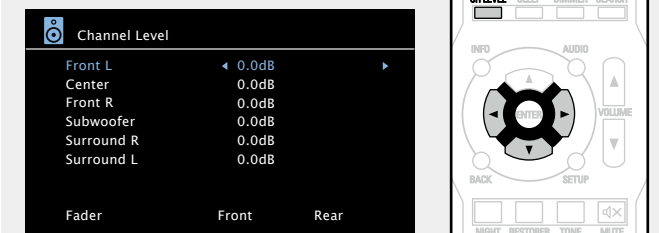

##### 2 Press $\nabla$ to select “Fader”, then select the item to be adjusting using $\triangleleft$ / $\triangleright$ .

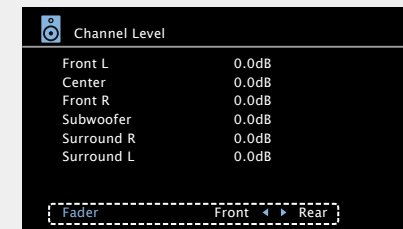

##### 3 Use $\triangleleft$ / $\triangleright$ to adjust the volume of the speakers. ( $\triangleleft$ : front, $\triangleright$ : rear)



- If you do not press any button for approximately 5 seconds, the menu screen light turns off.
- The fader function does not affect the subwoofer.
- The fader can be adjusted until the volume of the speaker is adjusted to the lowest value of -12 dB.

## Sleep timer function

The power automatically goes into standby once the set time has elapsed.

This is convenient for playing sources while going to sleep.

**Press SLEEP and display the time you want to set.**

The "SLEEP" indicator on the display lights.

- The time switches as shown below each time SLEEP is pressed.

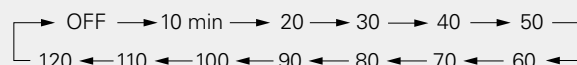

## To cancel the sleep timer

Press SLEEP to set "OFF".

The "SLEEP" indicator on the display turns off.



- If you do not press any button for approximately 5 seconds, the menu screen light turns off.
- The sleep timer setting is canceled if this unit's power is set to standby or turned off.

## Quick select function

You can save settings such as the input source selection, volume level, and sound mode at the QUICK SELECT 1 – 4 buttons.

You can simply press one of the set QUICK SELECT buttons for subsequent playback to switch to various saved settings all at once.

### Saving the settings

#### 1 Set the items below to the settings you want to save.

- Input source (page 14)
- Volume (page 14)
- Surround mode (page 18)
- Video Source (page 31)

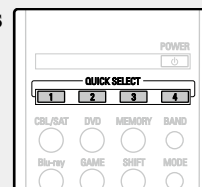

#### 2 Press and hold the desired QUICK SELECT until "Memory" appears on the display.

The current settings will be memorized.

[Quick select defaults]

	Input source	Volume	Surround mode	Video Source
QUICK SELECT 1	CBL/SAT	40	MULTI CH STEREO	SOURCE
QUICK SELECT 2	Blu-ray			
QUICK SELECT 3	GAME			
QUICK SELECT 4	AUX			

### Recalling the settings

Press QUICK SELECT at which the settings you want to call out are saved.

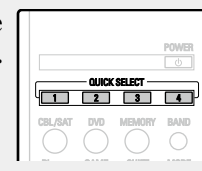

If QUICK SELECT on the main unit is pressed, the same function as with the remote control unit can be obtained.

## Various memory functions

### Personal memory plus function

This function sets the settings (input mode, surround mode, HDMI output mode, audio delay etc.) last selected for the individual input sources.



The surround parameters, tone settings and the volumes of the different speakers are stored for the individual surround modes.

### Last function memory

This function stores the settings which were made before going into the standby mode.

When the power is turned back on, the settings are restored.

# How to make detailed settings

## Menu map

For menu operation, connect a TV to this unit and display the menu on the TV screen. For menu operations, see the following page.

By default, this unit has recommended settings defined. You can customize this unit based on your existing system and your preferences.

The menu displayed depends on the input source and usage.

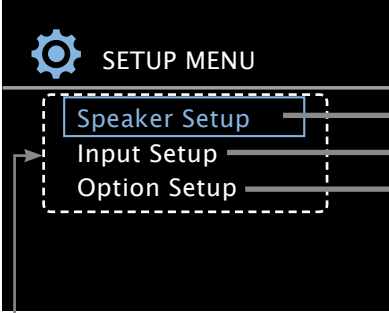



**Items that only need to be set once**

Set these for example upon purchase. Once these items are set, there is no need to set them again unless the speaker layout or the connected speakers have been changed.

Setting items	Detailed items	Description	Page
<b>Speaker Setup</b>	<b>Speaker Config.</b>	Selects speaker configuration and size (bass reproduction capability).	5
	<b>Bass Setting</b>	Sets subwoofer and LFE signal range playback.	6
	<b>Distance</b>	Sets distance from listening position to speakers.	6
	<b>Channel Level</b>	Sets the volume of the test tone to be the same when it is output from each speaker.	7
	<b>Crossover Freq.</b>	Sets the maximum frequency of the bass signal output from each channel to the subwoofer.	8
 Displayed items of the "Input Setup" menu differs, depending on the selected input source.	<b>Input Assign</b>	Changes input connector assignment.	<a href="#">30</a>
	<b>Auto Preset</b>	Uses the auto preset function to program radio stations.	<a href="#">31</a>
	<b>Preset Skip</b>	Sets the preset memories that you do not want to display when tuning.	<a href="#">31</a>
	<b>Video Source</b>	Video of another input source is played back combined with the playing audio.	<a href="#">31</a>
	<b>Input Mode</b>	Sets the audio input mode and decode mode.	<a href="#">31</a>
	<b>Source Level</b>	Adjusts the playback level of the audio input.	<a href="#">31</a>
	<b>Volume</b>	Sets the volume setting.	<a href="#">32</a>
	<b>HDMI</b>	Makes settings for HDMI.	<a href="#">33</a>
<b>Option Setup</b>	<b>Other</b>	Makes various other settings.	<a href="#">33</a>
	<b>Audio Adjust</b>	Adjusts surround sound parameters.	<a href="#">34</a>
<b>Tone</b>	Adjusts the tonal quality of the sound.	<a href="#">36</a>	
<b>NIGHT MODE</b>	Optimized setting for late-night listening. Compress dynamic range (difference between loud and soft sounds).	<a href="#">36</a>	
<b>RESTORER</b>	Expands the lower and higher regions of compressed audio to enable richer audio playback.	<a href="#">37</a>	
<b>Audio Delay</b>	Compensates for incorrect timing between video and audio.	<a href="#">37</a>	

# Examples of menu and front display

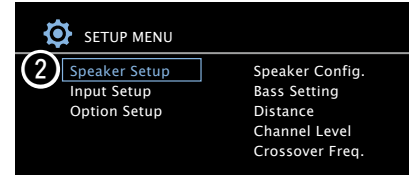
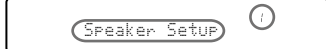
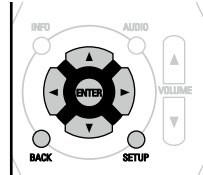
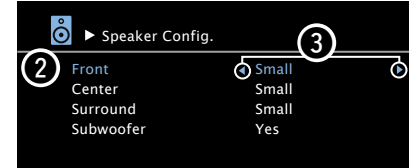
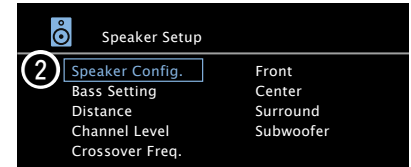
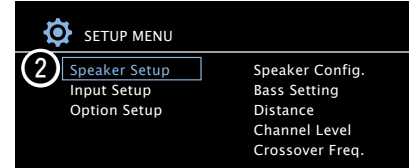
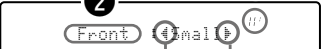
Below we describe typical examples of displays on the TV screen and on the set's display window.

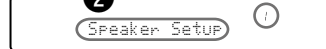
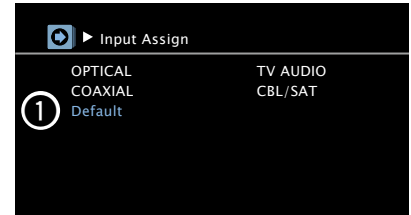
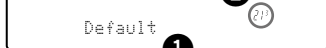
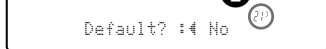
	Menu display	Front display	Description
<b>Top menu display</b>			<ol style="list-style-type: none"> <li>1 Press <b>SETUP</b> to display the menu screen.</li> <li>2 TV screen: Displays the selected line. Display: Displays the selected item.</li> <li>3 The number of the current selected setting menu is displayed.</li> </ol> 
<b>Display when changing settings</b>	 <p>4 Press <b>ENTER</b>.</p>  <p>5 Press <b>BACK</b>.</p> 	 <p>4 Press <b>ENTER</b>.</p>  <p>5 Press <b>BACK</b>.</p> 	<ol style="list-style-type: none"> <li>1 The number of the current selected setting menu is displayed.</li> <li>2 TV screen: Displays the selected line. Display: Displays the selected item.</li> <li>3 ◀ ▶ is displayed at the sides of items whose setting can be changed. Use ◀ ▶ to change to the desired setting.</li> <li>4 Press <b>ENTER</b> to set to the mode in which the setting can be made.</li> <li>5 Press <b>BACK</b> to return to the previous menu.</li> </ol>
<b>Display when resetting</b>		 <p>Press <b>ENTER</b>.</p> 	<ol style="list-style-type: none"> <li>1 Press ▼ to select "Default", then press <b>ENTER</b>.</li> <li>2 The number of the current selected setting menu is displayed.</li> <li>3 Press ◀ to select "Yes", then press <b>ENTER</b>.</li> </ol>



## Input Setup

Perform settings related to input source playback.

- You do not have to change the settings to use the unit. Make settings when needed.

### Menu operation

- 1 Press SETUP.**  
The menu is displayed on the TV screen.
- 2 Use  $\Delta$ / $\nabla$  to select “Input Setup”, and then press ENTER.**
- 3 Use  $\Delta$ / $\nabla$  to select the menu to be set or operated.**
- 4 Press ENTER to enter the setting.**

- To return to the previous item, press **BACK**.
- Exiting the Menu, press **SETUP** while the menu is displayed.  
The menu display disappears.

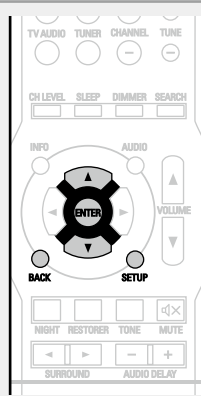

### Important information

#### □ About the display of input sources

In this section, the configurable input sources for each item are shown as follows.

**Blu-ray** **DVD** **TV AUDIO** **CBL/SAT** **GAME** **AUX** **TUNER**

### Items that can be set with the “Input Setup” procedure

Input Assign (👉 page 30)

Auto Preset (👉 page 31)

Preset Skip (👉 page 31)

Video Source (👉 page 31)

Input Mode (👉 page 31)

Source Level (👉 page 31)



# Input Assign

Default settings are underlined.

This unit has certain input sources such as "CBL/SAT" assigned to audio and video connectors by default. By making the default connections, you can simply press an input source select button to play back audio or video from the connected device with ease.

When making connections other than the default settings, you must change settings in this section.

## Examples of "Input Assign" menu screen displays

This screen appears when the "Input Setup" – "Input Assign" menu is selected. Use the "Input Assign" menu to change the digital input connectors that are assigned to the input sources in default settings.

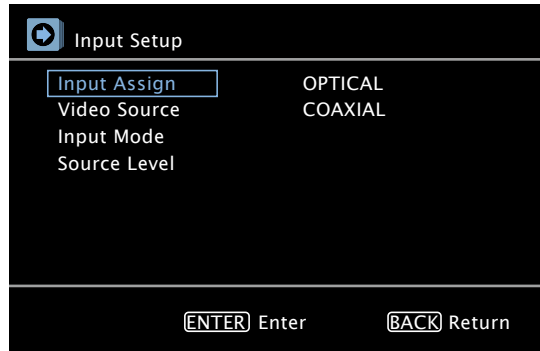

## Input assignments menu operations

- 1 Use  $\Delta$ / $\nabla$  to select "Input Assign", and then press **ENTER**.
- 2 Use  $\Delta$ / $\nabla$ / $\leftarrow$ / $\rightarrow$  to select the input connector to be assigned.
- 3 Press **ENTER** to enter the setting.

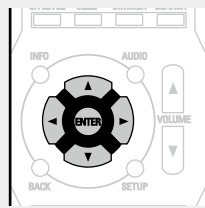

### NOTE

- If all "OPTICAL" and "COAXIAL" assignment of the TV source are set to "OFF", TV source cannot be selected with the input source selection.
- The unit supports 3 types of digital audio connection (HDMI, OPTICAL, and COAXIAL). Do not make multiple digital audio connections with a single device. However, you can make both analog and digital connections with the same source. In this case, priority is given to the HDMI input signal when making both analog and HDMI connections. Priority is also given to the digital input signal (OPTICAL/COAXIAL) when making both analog and digital connections (OPTICAL/COAXIAL).

Setting items	Setting details
<b>OPTICAL</b> Set this to change the optical input connectors assigned to the input sources. <div style="display: flex; justify-content: space-around;"> <div style="border: 1px solid black; padding: 2px;">Blu-ray</div> <div style="border: 1px solid black; padding: 2px;">DVD</div> </div> <div style="display: flex; justify-content: space-around;"> <div style="border: 1px solid black; padding: 2px;">TV AUDIO</div> <div style="border: 1px solid black; padding: 2px;">CBL/SAT</div> </div> <div style="display: flex; justify-content: space-around;"> <div style="border: 1px solid black; padding: 2px;">GAME</div> <div style="border: 1px solid black; padding: 2px;">AUX</div> </div>	<b>Blu-ray / DVD / TV AUDIO / CBL/SAT / GAME / AUX</b> <b>OFF</b> : Do not assign a optical input connector to the selected input source.
<b>COAXIAL</b> Set this to change the coaxial input connectors assigned to the input sources. <div style="display: flex; justify-content: space-around;"> <div style="border: 1px solid black; padding: 2px;">Blu-ray</div> <div style="border: 1px solid black; padding: 2px;">DVD</div> </div> <div style="display: flex; justify-content: space-around;"> <div style="border: 1px solid black; padding: 2px;">TV AUDIO</div> <div style="border: 1px solid black; padding: 2px;">CBL/SAT</div> </div> <div style="display: flex; justify-content: space-around;"> <div style="border: 1px solid black; padding: 2px;">GAME</div> <div style="border: 1px solid black; padding: 2px;">AUX</div> </div>	<b>Blu-ray / DVD / TV AUDIO / CBL/SAT / GAME / AUX</b> <b>OFF</b> : Do not assign a coaxial input connector to the selected input source.
<b>Default</b> The "Input Assign" settings are returned to the default settings.	<b>Yes</b> : Reset to the defaults. <b>No</b> : Do not reset to the defaults. If you select "Default" and press <b>ENTER</b> , the message "Return settings to the default?" is displayed. Select "Yes" or "No", and then press <b>ENTER</b> .

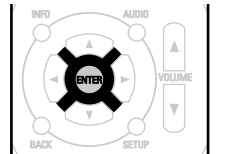

## Auto Preset

Use the auto preset function to program radio stations.

Setting items	Setting details
<b>Start</b> Start the auto preset process. TUNER	 If an FM station cannot be preset automatically, select the desired station by tuning it in manually, then preset it manually.

## Preset Skip

Default settings are underlined.

Set the preset memory block (from A to G) you do not want to display.

Setting items	Setting details
<b>Block A – Block G</b> Select a block to be skipped from among preset blocks (from A to G). TUNER	<b>ON</b> : Display the selected preset memory block. <b>SKIP</b> : Do not display the selected preset memory block.

## Video Source

Default settings are underlined.

Video of another input source is played back combined with the playing audio.

Setting items	Setting details
<b>Video Source</b>	<b>Source</b> : Play the picture and sound of the input source. <b>DVD / CBL/SAT</b> : Select video input source to view. This can be set for individual input sources. <div style="border: 1px solid black; border-radius: 10px; padding: 2px; display: inline-block; margin-top: 5px;">NOTE</div> It is not possible to select HDMI input signals.

## Input Mode

Default settings are underlined.

The input modes available for selection may vary depending on the input source.

Setting items	Setting details																
<b>Input Mode</b> Set the audio input modes for the different input sources. It is normally recommended to set the audio input mode to "Auto".	<b>Auto</b> : Automatically detect input signal and perform playback. <b>HDMI</b> : Play only signals from HDMI input. <b>Digital</b> : Play only signals from digital input (OPTICAL/COAXIAL). <b>Analog</b> : Play only signals from analog input. <ul style="list-style-type: none"> <li>At time of purchase, the settings of the different input sources are as shown below.</li> </ul> <table border="1" style="margin: 10px 0;"> <tr> <td>Input source</td> <td>Blu-ray</td> <td>DVD</td> <td>TV AUDIO</td> <td>CBL/SAT</td> </tr> <tr> <td>Default setting</td> <td>HDMI</td> <td>Analog</td> <td>Digital</td> <td>Auto</td> </tr> </table> <table border="1" style="margin: 10px 0;"> <tr> <td>Input source</td> <td>GAME</td> <td>AUX</td> </tr> <tr> <td>Default setting</td> <td>HDMI</td> <td>Auto</td> </tr> </table> <ul style="list-style-type: none"> <li>"Digital" can be set for the input source assigned to "OPTICAL" or "COAXIAL" under "Input Assign" in the menu.</li> <li>If the input source is set to "Blu-ray", "TV AUDIO" or "GAME", it cannot be set to "Analog".</li> <li>If an input source is "TUNER", the setting is fixed to "Analog".</li> <li>When digital signals are properly input, the <b>DIG.</b> indicator lights on the display. If the <b>DIG.</b> indicator does not light, check the digital input connector assignment and the connections.</li> </ul>	Input source	Blu-ray	DVD	TV AUDIO	CBL/SAT	Default setting	HDMI	Analog	Digital	Auto	Input source	GAME	AUX	Default setting	HDMI	Auto
Input source	Blu-ray	DVD	TV AUDIO	CBL/SAT													
Default setting	HDMI	Analog	Digital	Auto													
Input source	GAME	AUX															
Default setting	HDMI	Auto															
<b>Decode Mode</b> Set the audio decode mode for input source.	<b>Auto</b> : Detect type of digital input signal and decode and play automatically. <b>PCM</b> : Decode and play only PCM input signals. <b>DTS</b> : Decode and play only DTS input signals. <ul style="list-style-type: none"> <li>This item can be set for input sources for which "OPTICAL" or "COAXIAL" is assigned at "Input Assign" (<a href="#">page 30</a>).</li> <li>This item can be set for HDMI input sources (Blu-ray, GAME, CBL/SAT or AUX).</li> <li>Normally set this mode to "Auto". Set "PCM" and "DTS" when inputting the corresponding input signal.</li> </ul>																

## Source Level

Default settings are underlined.

This function corrects the playback level of the selected input source's audio input. Make this setting if there are differences in the input volume levels between the different sources.

Setting items	Setting details
<b>Source Level</b>	-12dB – +12dB (0dB)



## Option Setup

Make various option settings.

### Menu operation

- 1** Press **SETUP**.  
The menu is displayed on the TV screen.
- 2** Use  $\Delta$ / $\nabla$  to select “Option Setup”, and then press **ENTER**.
- 3** Use  $\Delta$ / $\nabla$  to select the menu to be set or operated.
- 4** Press **ENTER** to enter the setting.

- To return to the previous item, press **BACK**.
- Exiting the Menu, press **SETUP** while the menu is displayed.  
The menu display disappears.

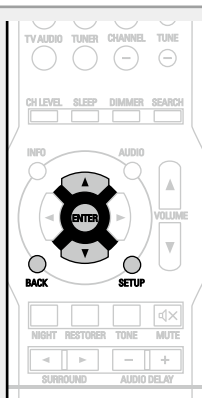

### Items that can be set with the “Option Setup” procedure

Volume (👉 page 32)

HDMI (👉 page 33)

Other (👉 page 33)

## Volume

Default settings are underlined.

Sets the volume setting.

Setting items	Setting details
<b>Scale</b> Set how volume is displayed.	<b>Absolute</b> : Display in the range 0.0 (Min) to 98. <b>Relative</b> : Display —dB (Min), in the range –79.5 dB to 18 dB. The “Scale” setting is applied also to the “Limit” and “Power On Level” display method.
<b>Limit</b> Make a setting for maximum volume.	<b>OFF</b> : Do not set a maximum volume. <b>60 (–20dB) / 70 (–10dB) / 80 (0dB)</b> If “Scale” is set to “Relative”, the value in ( ) is displayed.
<b>Power On Level</b> Define the volume setting that is active when the power is turned on.	<b>Last</b> : Use the memorized setting from the last session. <b>0 (– – –)</b> : Always use the muting on condition when power is turned on. <b>1 – 98 (–79dB – 18dB)</b> : The volume is adjusted to the set level.
<b>Mute Level</b> Set the amount of attenuation when muting is on.	<b>Full</b> : The sound is muted entirely. <b>–40dB</b> : The sound is attenuated by 40 dB down. <b>–20dB</b> : The sound is attenuated by 20 dB down.

## HDMI

Default settings are underlined.

Makes settings for HDMI.

Setting items	Setting details
<b>HDMI Audio Out</b> Select HDMI audio output device.	<b>Amp</b> : Play back through speakers connected to the receiver. <b>TV</b> : Play back through TV connected to the receiver. If "TV" is selected, only an HDMI audio signal is output from the TV.
<b>Standby Pass</b> Outputs signals received from the HDMI input connector to the TV connected to the HDMI output connector even when the unit is in standby mode.	<b>OFF</b> : "Standby Pass" is disabled. <b>Last</b> : "Standby Pass" is enabled when the last input source used outputs an HDMI signal. <b>CBL/SAT</b> : "Standby Pass" is enabled when an HDMI signal is input to the HDMI CBL/SAT connector on the unit. <b>Blu-ray</b> : "Standby Pass" is enabled when an HDMI signal is input to the HDMI Blu-ray connector on the unit. <b>GAME</b> : "Standby Pass" is enabled when an HDMI signal is input to the HDMI GAME connector on the unit. <b>AUX</b> : "Standby Pass" is enabled when an HDMI signal is input to the HDMI AUX connector on the unit. When this setting is enabled the power indicator turns red when entering standby mode, and more power is consumed than in normal standby mode. <b>NOTE</b> When this setting is enabled, the "Sleep timer function" (page 26) is turned "OFF" and the "Auto Standby" (page 33) setting is disabled.

## Other

Default settings are underlined.

Make various other settings.

Setting items	Setting details
<b>Auto Standby</b> The unit enters standby mode automatically when no commands are sent to the unit for the set time. Before it enters the standby mode, "Auto Standby" is displayed on the display of this unit and the menu screen.	<b>2Hours</b> : The unit goes into standby after 2 hours. <b>4Hours</b> : The unit goes into standby after 4 hours. <b>8Hours</b> : The unit goes into standby after 8 hours. <b>OFF</b> : The unit does not go into standby automatically.
<b>Setup Lock</b> Protect settings from inadvertent change.	<b>ON</b> : Turn protection on. <b>OFF</b> : Turn protection off. To turn OFF the "Setup Lock", follow the procedure below. ① Press and hold <b>SETUP</b> for at least 3 seconds. "Setup Lock: ON" appears on the display. ② Use ◀▶ to select "OFF", and then press <b>ENTER</b> . <b>NOTE</b> When "Setup Lock" is set to "ON", the settings listed below can no longer be changed. Also, "Setup Lock!" is displayed if you attempt to operate related settings. <ul style="list-style-type: none"> <li>• Setup menu operations</li> <li>• RESTORER</li> <li>• Channel Level</li> <li>• Audio Adjust</li> <li>etc.</li> </ul>

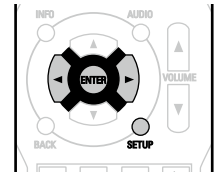



# Adjusting the sound field effects

The sound being played in the surround mode can be adjusted to your liking. The items (parameters) that can be adjusted depend on the signal being input and the currently set surround mode. For details on the adjustable parameters, see "Surround modes and surround parameters" (page 46).

### NOTE

Some setting items cannot be set while playback is stopped. Make the settings during playback.

## Items that can be set with the audio adjust procedure

Audio Adjust (page 34)

Tone (page 36)

NIGHT MODE (page 36)

RESTORER (page 37)

Audio Delay (page 37)

## Audio Adjust

Default settings are underlined.

Adjust surround sound parameters. It may not be possible to set this item depending on the input signal.

### Menu operations

**1** Press **AUDIO** and then press **ENTER**.  
The menu is displayed on the TV screen.

**2** Use  $\Delta$ / $\nabla$  to select the menu to be set or operated.



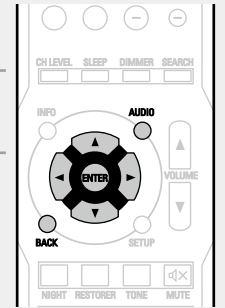

**3** Use  $\leftarrow$ / $\rightarrow$  to enter the setting.

- To return to the previous item, press **BACK**.
- Exiting the Menu, press **AUDIO** while the menu is displayed. The menu display disappears.



Setting items	Setting details
<b>Mode</b> Set the play modes for the different surround modes.	<input type="checkbox"/> <b>In the PLII mode</b> <b>Cinema</b> : Surround sound mode optimized for movie sources. <b>Music</b> : Surround sound mode optimized for music sources. <b>Game</b> : Surround sound mode optimized for games. <b>Pro Logic</b> : Dolby Pro Logic playback mode. <input type="checkbox"/> <b>In the DTS NEO:6 mode</b> <b>Cinema</b> : Surround sound mode optimized for movie sources. <b>Music</b> : Surround sound mode optimized for music sources. The "Music" mode is also effective for movie sources including a lot of stereo music.
<b>LFE</b> Adjust the low-frequency effects level (LFE).	<b>-10dB - 0dB</b> For proper playback of the different sources, we recommend setting to the values below. <ul style="list-style-type: none"> <li>• Dolby Digital sources : "0dB"</li> <li>• DTS movie sources : "0dB"</li> <li>• DTS music sources : "-10dB"</li> </ul>

Setting items	Setting details
<b>D.Comp</b> Compress dynamic range (difference between loud and soft sounds).	<b>Low / Mid / High</b> : These set the compression level. <b>OFF</b> : Turn dynamic range compression off.
<b>DRC</b> This can be set in the Dolby TrueHD mode. Compress dynamic range (difference between loud and soft sounds).	<b>Auto</b> : Automatic dynamic range compression on/off control according to source. <b>Low / Mid / High</b> : These set the compression level. <b>OFF</b> : Dynamic range compression always off.
<b>Center Image</b> Distributes the dialogue output from the center channel to the front left and right channels and widens the sound image in the front. You can set this when the surround mode is set to DTS NEO:6 in the "Music" mode.	<b>0.0 – 1.0 (0.3)</b>  The smaller the value, the more dialogue is concentrated on the center channel. The larger the value, the more dialogue is distributed to front left and right channels, and the more the sound image widens in the front.
<b>Panorama</b> Assign front L/R signal also to surround channels for wider sound. You can set this when the surround mode is set to Dolby PLII in the "Music" mode.	<b>ON</b> : Set. <b>OFF</b> : Do not set.

Setting items	Setting details
<b>Dimension</b> Shift sound image center to front or rear to adjust playback balance. You can set this when the surround mode is set to Dolby PLII in the "Music" mode.	<b>0 – 6 (3)</b>  As you set a smaller number, the surround sound field shifts backward; as you set a larger number, the surround sound field shifts forward.
<b>Center Width</b> Distributes the dialogue output from the center channel to left and right channels and widens the sound image in the front. You can set this when the surround mode is set to Dolby PLII in the "Music" mode.	<b>0 – 7 (3)</b>  The smaller the value, the more dialogue is concentrated on the center channel. The larger the value, the more dialogue is distributed to front left and right channels, and the more the sound image widens in the front.
<b>Subwoofer</b> Turn subwoofer output on and off.	<b>ON</b> : The subwoofer is used. <b>OFF</b> : The subwoofer is not used. <div style="background-color: #f08080; border-radius: 10px; padding: 2px; display: inline-block; margin-top: 5px;"><b>NOTE</b></div> This can be set when the surround mode is "DIRECT" (  page 20) and the "SW Mode" (  page 6 "Bass Setting") is "LFE+Main".
<b>Default</b> The "Audio Adjust" settings are returned to the default settings.	<b>Yes</b> : Reset to the defaults. <b>No</b> : Do not reset to the defaults.

## Tone

around items indicate the settings made upon purchase.

Adjust the tonal quality of the sound.

### 1 Press TONE.

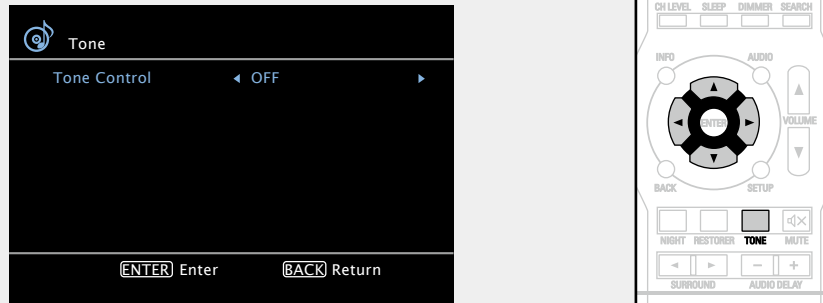

### 2 Use ◀▶ to select "ON".

**ON** Allow tone adjustment (bass, treble).

**OFF** Playback without tone adjustment.

#### NOTE

The tone cannot be adjusted in the direct mode.

### 3 Press ▲▼ to select an item to be set, and use ◀▶ to select a setting value.

**Bass** Adjust low frequency range (bass).

- **-6dB - +6dB (0dB)**

**Treble** Adjust high frequency range (treble).

- **-6dB - +6dB (0dB)**



"Bass" or "Treble" can be set when "Tone Control" is set to "ON".

## NIGHT MODE

around items indicate the settings made upon purchase.

Optimized setting for late-night listening.

- If you do not press any button for approximately 5 seconds, the menu screen light turns off.

### Press NIGHT to select your desired mode.

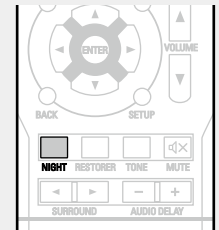
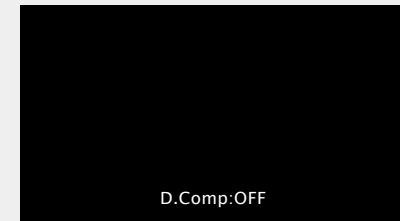

**OFF** Not set.

**Low** Set the adjusted value to "Low".

**Mid** Set the adjusted value to "Middle".

**High** Set the adjusted value to "High".



When a Dolby TrueHD signal is output, "DRC" is displayed on the TV screen. The setting mode is also changed as shown below.

**OFF** Not set.

**Low** Set the adjusted value to "Low".

**Mid** Set the adjusted value to "Middle".

**High** Set the adjusted value to "High".

**Auto** Automatic dynamic range compression on/off control according to the source.

## RESTORER

around items indicate the settings made upon purchase.

Compressed audio formats such as MP3, WMA (Windows Media Audio) and MPEG-4 AAC reduce the amount of data by eliminating signal components that are hard for the human ear to hear. The RESTORER function generates the signals eliminated upon compression, restoring the sound to conditions near those of the original sound before compression. It also corrects the sense of volume of the bass to obtain richer sound with compressed audio signals.

- If you do not press any button for approximately 5 seconds, the menu screen light turns off.

Press **RESTORER** to select “ON” or “OFF”.

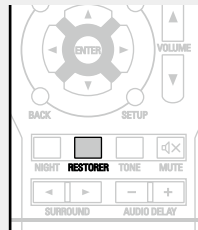

**ON** Use RESTORER.

**OFF** Do not use RESTORER.



- This item can be set with analog signals or when a PCM signal (fs = 44.1/48 kHz) is input.
- This cannot be set when the surround mode is set to “DIRECT”.

## Audio Delay

around items indicate the settings made upon purchase.

While viewing video, manually adjust the time to delay audio output.

- If you do not press any button for approximately 5 seconds, the menu screen light turns off.

Use **AUDIO DELAY +, -** to select the value to be set.

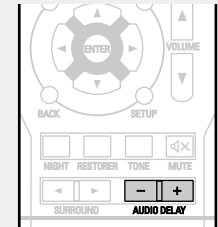
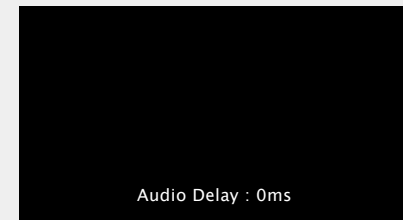

**0ms** - **200ms**



Store “Audio Delay” for each input source.



## Information

Information on the main unit's various settings (Status) and on input signals (Audio Input Signal) is shown on the display.

The information displayed changes each time you press **STATUS** on the main unit.

The information is displayed for several seconds before the display returns to its original condition.

### [Items to be checked]

- Input source
- Surround mode
- Input digital terminal  
etc.



Press **INFO** on the remote control to display current source name, volume, surround mode name, and other information at the bottom of the screen.

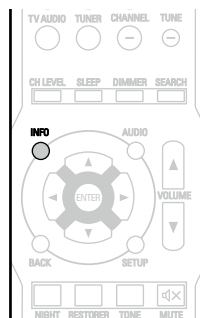
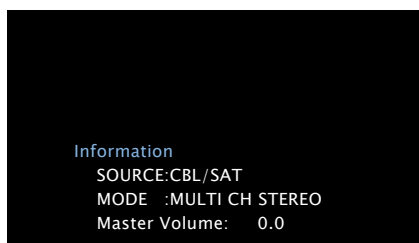

### NOTE

The information displayed differs according to the input source.

#### Dialogue normalization function

This function is automatically activated when playing Dolby Digital sources.  
It automatically corrects the standard signal level for individual program sources.  
The correction value can be checked using **STATUS** on the main unit.





Offset: -4dB

The figure is the corrected value. This cannot be changed.

## Information

---

Here, we list various information related to this unit.  
Please refer to this information as needed.

- Part names and functions  [page 40](#)
- Other information  [page 45](#)
- Troubleshooting  [page 52](#)
- Specifications  [page 54](#)
- Index  [page 55](#)

# Part names and functions

## Front panel

For buttons not explained here, see the page indicated in parentheses ( ).

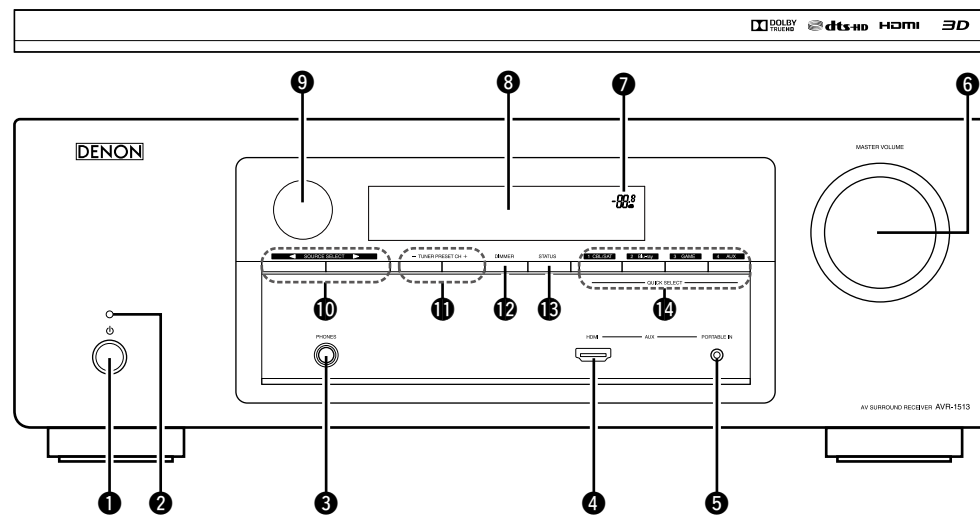

- |  |  |  |
|--|--|--|
| <p><b>1 Power operation button (⏻)</b> ..... (4, 8)<br/>Turns power to this unit on and off (standby).</p> <p><b>2 Power indicator</b> ..... (4, 8)<br/><b>[Power indicator status]</b></p> <ul style="list-style-type: none"> <li>• Power on : Green</li> <li>• Normal standby : Off</li> <li>• Standby when “Standby Pass” (page 33) is not set to “OFF” : Red</li> </ul> <p><b>3 Headphones jack (PHONES)</b><br/>When the headphones are plugged into this jack, audio will no longer be output from the connected speakers.</p> | <p><b>4 AUX HDMI connector</b> ..... (7)</p> <p><b>5 AUX PORTABLE IN jack</b> ..... (13)</p> <p><b>6 MASTER VOLUME control knob</b> ..... (14)</p> <p><b>7 Master volume indicator</b></p> <p><b>8 Display</b> ..... (41)</p> <p><b>9 Remote control sensor</b> ..... (44)</p> | <p><b>10 SOURCE SELECT buttons (◀ ▶)</b> ..... (14)</p> <p><b>11 Tuner preset channel buttons (TUNER PRESET CH +, -)</b> ..... (17)</p> <p><b>12 DIMMER button</b> ..... (15)</p> <p><b>13 STATUS button</b> ..... (38)</p> <p><b>14 QUICK SELECT buttons</b> ..... (26)</p> |
|--|--|--|

**NOTE**

To prevent hearing loss, do not raise the volume level excessively when using headphones.

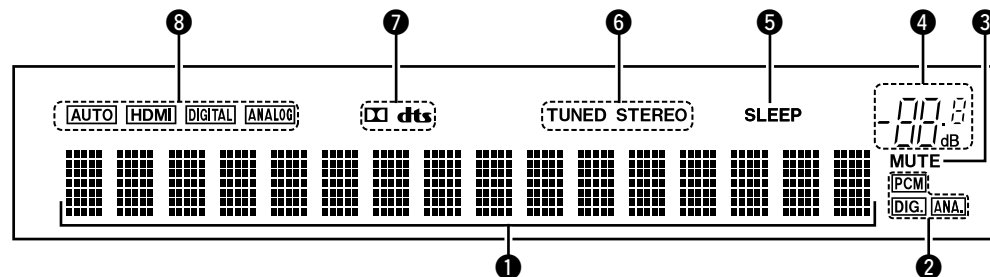

## 1 Information display

The input source name, surround mode, setting values and other information are displayed here.

## 2 Input signal indicators

### 3 MUTE indicator

This lights when the mute mode is selected ([page 14](#)).

## 4 Master volume indicator

## 5 Sleep timer indicator

This lights when the sleep mode is selected ([page 26](#)).

## 6 Tuner reception mode indicators

These light according to the reception conditions when the input source is set to "TUNER".

**STEREO** : In the FM mode, this lights up when receiving stereo broadcasts.

**TUNED** : Lights up when the broadcast is properly tuned in.

## 7 Decoder indicators

These light when Dolby or DTS signals are input or when the Dolby or DTS decoder is running.

## 8 Input mode indicators

Set the audio input modes for the different input sources ([page 31](#)).

# Rear panel

See the page indicated in parentheses ( ).

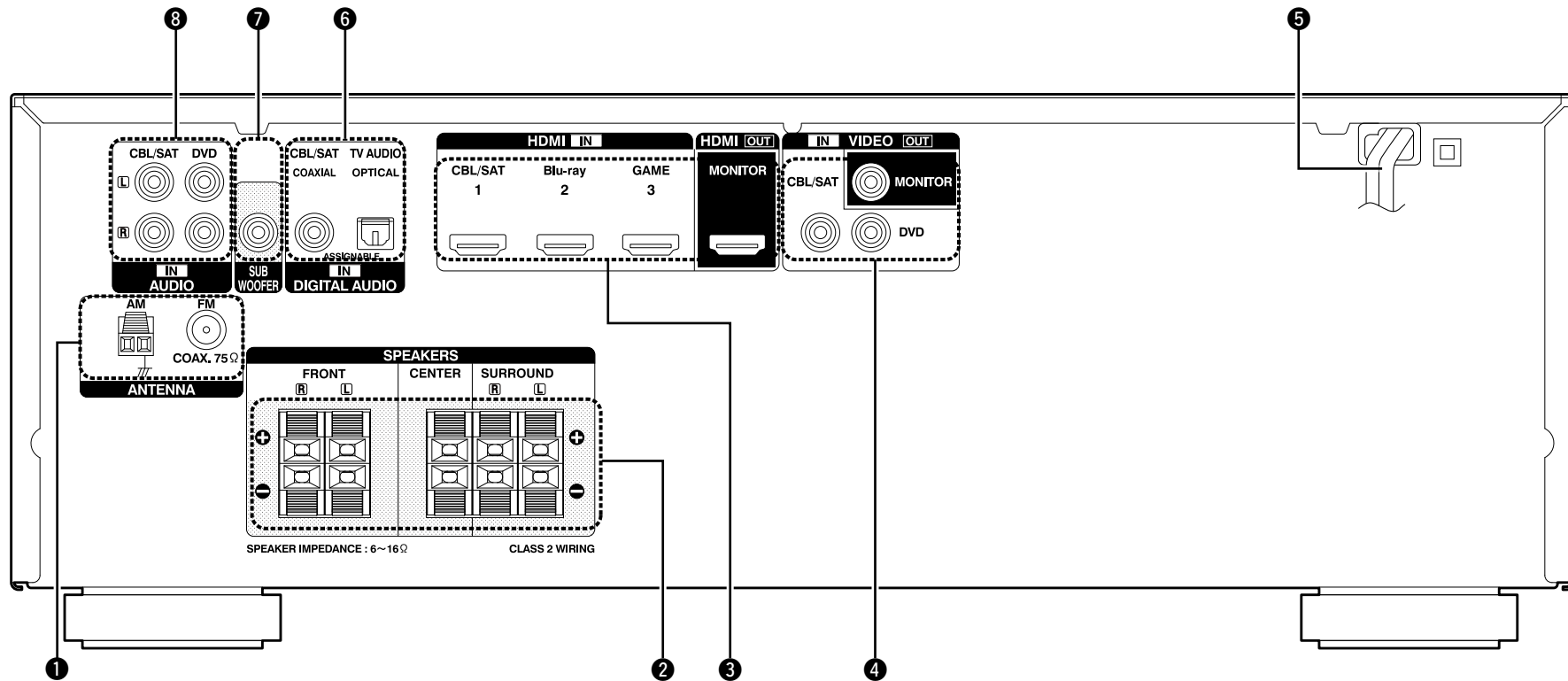

- |   |  |
|---|--|
| ① FM/AM antenna terminals (ANTENNA)..... (13)   | ⑤ Power cord..... (4)  |
| ② Speaker terminals (SPEAKERS)..... (3, 23, 24) | ⑥ Digital audio connectors (DIGITAL AUDIO)..... (10, 11, 12) |
| ③ HDMI connectors..... (4, 6, 7)                | ⑦ SUBWOOFER connector..... (23, 24)                          |
| ④ VIDEO connectors..... (10, 11, 12)            | ⑧ Analog audio connectors (AUDIO)..... (11, 12)              |

**NOTE**

Do not touch the inner pins of the connectors on the rear panel. Electrostatic discharge may cause permanent damage to the unit.

# Remote control unit

For buttons not explained here, see the page indicated in parentheses ( ).

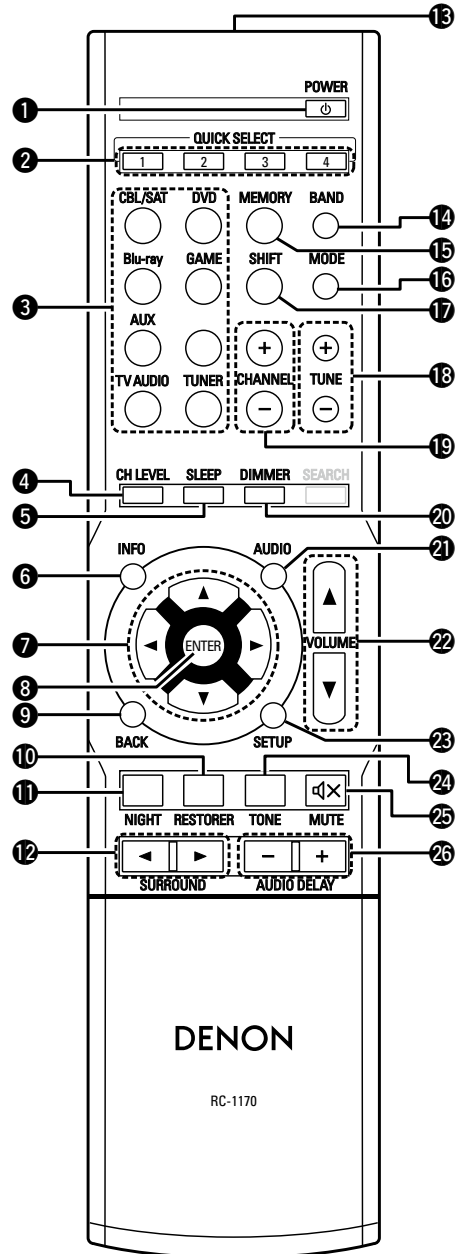

- 1 POWER button (⏻) ..... (4, 8)
  - 2 QUICK SELECT buttons (1 – 4) ..... (26)
  - 3 Input source select buttons ..... (14)
  - 4 Channel level button (CH LEVEL) ..... (25)
  - 5 SLEEP button ..... (26)
  - 6 Information button (INFO) ..... (38)
  - 7 Cursor buttons (▲▼◀▶) ..... (28, 29)
  - 8 ENTER button ..... (28, 29)
  - 9 BACK button ..... (28, 29)
  - 10 RESTORER button ..... (37)
  - 11 NIGHT button ..... (36)
  - 12 SURROUND buttons  
(◀▶) ..... (18, 19, 20)
  - 13 Remote control signal transmitter ..... (44)
  - 14 BAND button ..... (16)
  - 15 MEMORY button ..... (16)
  - 16 MODE button ..... (16)
  - 17 SHIFT button ..... (16, 17)
  - 18 Tuning buttons (TUNE +, -) ..... (16)
  - 19 CHANNEL buttons (+, -) ..... (16, 17)
  - 20 DIMMER button ..... (15)
  - 21 AUDIO button ..... (19, 34)
  - 22 VOLUME buttons (▲▼) ..... (14)
  - 23 SETUP button ..... (28, 29)
  - 24 TONE button ..... (36)
  - 25 MUTE button (🔇) ..... (14)
  - 26 AUDIO DELAY buttons (+, -) ..... (37)
- NOTE**  
The **SEARCH** button cannot be used.

## Inserting the batteries

- ① Remove the rear lid in the direction of the arrow and remove it.
- ② Load the two batteries properly as indicated by the marks in the battery compartment.

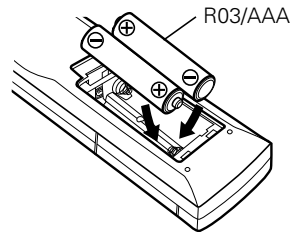
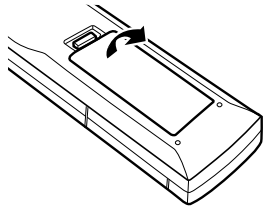

- ③ Put the rear cover back on.

### NOTE

- Insert the specified batteries in the remote control unit.
- Replace the batteries with new ones if the set does not operate even when the remote control unit is operated close to the unit. (The supplied batteries are only for verifying operation.)
- When inserting the batteries, be sure to do so in the proper direction, following the ⊕ and ⊖ marks in the battery compartment.
- To prevent damage or leakage of battery fluid:
  - Do not use a new battery together with an old one.
  - Do not use two different types of batteries.
  - Do not attempt to charge dry batteries.
  - Do not short-circuit, disassemble, heat or dispose of batteries in flames.
  - Do not keep the battery in a place exposed to direct sunlight or in places with extremely high temperatures, such as near a heater.
- If the battery fluid should leak, carefully wipe the fluid off the inside of the battery compartment and insert new batteries.
- Remove the batteries from the remote control unit if it will not be in use for long periods.
- Used batteries should be disposed of in accordance with the local regulations regarding battery disposal.
- The remote control unit may function improperly if rechargeable batteries are used.

## Operating range of the remote control unit

Point the remote control unit at the remote sensor when operating it.

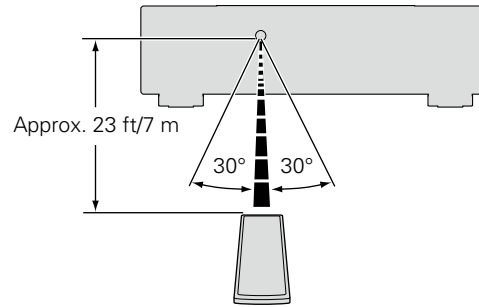

### NOTE



- The set may function improperly or the remote control unit may not operate if the remote control sensor is exposed to direct sunlight, strong artificial light from an inverter type fluorescent lamp or infrared light.
- When using 3D video devices that transmit radio communication signals (such as infrared signals etc) between the various units (such as the monitor, 3D glasses, 3D transmitter unit etc), the remote control unit may not operate due to interference from those radio communication signals. If this occurs, adjust the direction and distance of the 3D communication for each unit, and check that the remote control unit operation is not affected by these signals.

# Other information

- ❑ **Trademark information** ([page 45](#))
- ❑ **Surround** ([page 46](#))
- ❑ **Relationship between video signals and monitor output** ([page 49](#))
- ❑ **Explanation of terms** ([page 50](#))

## Trademark information

This product uses the following technologies:

	Manufactured under license from Dolby Laboratories. "Dolby", "Pro Logic" and the double-D symbol are trademarks of Dolby Laboratories.
	Manufactured under license under U.S. Patent Nos: 5,956,674; 5,974,380; 6,226,616; 6,487,535; 7,212,872; 7,333,929; 7,392,195; 7,272,567 & other U.S. and worldwide patents issued & pending. DTS-HD, the Symbol, & DTS-HD and the Symbol together are registered trademarks of DTS, Inc. Product includes software. © DTS, Inc. All Rights Reserved.
	HDMI, the HDMI Logo and High-Definition Multimedia Interface are trademarks or registered trademarks of HDMI Licensing LLC in the United States and other countries.



# Surround







This unit is equipped with a digital signal processing circuit that lets you play program sources in the surround mode to achieve the same sense of presence as in a movie theater.

## Surround modes and surround parameters

This table shows the speakers that can be used in each surround mode and the surround parameters adjustable in each surround mode.

### Symbols in the table

- This indicates the audio output channels or surround parameters that can be set.
- ⊙ This indicates the audio output channels. The output channels depend on the settings of  page 5 “Speaker Config.”.

Surround mode (  page 18)	Channel output				Audio Adjust (  page 34)			
	Front L/R	Center	Surround L/R	Subwoofer	Mode (  page 34)	LFE *4 (  page 34)	D. Comp *2 (  page 35)	DRC *3 (  page 35)
DIRECT (2 channel)	○			⊙*1			○	○
DIRECT (Multi-channel)	○	⊙	⊙	⊙		○	○	○
STEREO	○			⊙		○	○	○
MULTI CH IN	○	⊙	⊙	⊙		○		
DOLBY PRO LOGIC II	○	⊙	⊙	⊙	○		○	○
DTS NEO:6	○	⊙	⊙	⊙	○		○	○
DOLBY DIGITAL	○	⊙	⊙	⊙		○	○	
DOLBY DIGITAL Plus	○	⊙	⊙	⊙		○	○	
DOLBY TrueHD	○	⊙	⊙	⊙		○		
DTS SURROUND	○	⊙	⊙	⊙		○	○	
DTS 96/24	○	⊙	⊙	⊙		○	○	
DTS-HD	○	⊙	⊙	⊙		○	○	
DTS Express	○	⊙	⊙	⊙		○	○	
MULTI CH STEREO	○	⊙	⊙	⊙		○	○	
VIRTUAL	○			⊙*1		○	○	

- \*1 Only when “SW Mode” is set to “LFE+Main” ( page 6 “Bass Setting”), sound is output from the subwoofer.
- \*2 This item can be selected when a Dolby Digital or DTS signal is played.
- \*3 This item can be selected when a Dolby TrueHD signal is played.
- \*4 This item can be selected when a Dolby Digital or DTS signal or DVD-Audio is played.

Surround mode (🔗 page 18)	Audio Adjust (🔗 page 34)				Tone (🔗 page 36)	RESTORER *5 (🔗 page 37)	
	Subwoofer (🔗 page 35)	PRO LOGIC II Music mode only					NEO:6 Music mode only
		Panorama (🔗 page 35)	Dimension (🔗 page 35)	Center Width (🔗 page 35)			Center Image (🔗 page 35)
DIRECT (2 channel)	<input type="radio"/> *1						
DIRECT (Multi-channel)							
STEREO					<input type="radio"/>	<input type="radio"/>	
MULTI CH IN					<input type="radio"/>		
DOLBY PRO LOGIC II		<input type="radio"/>	<input type="radio"/>	<input type="radio"/>	<input type="radio"/>	<input type="radio"/>	
DTS NEO:6				<input type="radio"/>	<input type="radio"/>	<input type="radio"/>	
DOLBY DIGITAL					<input type="radio"/>		
DOLBY DIGITAL Plus					<input type="radio"/>		
DOLBY TrueHD							
DTS SURROUND					<input type="radio"/>		
DTS 96/24					<input type="radio"/>		
DTS-HD							
DTS Express					<input type="radio"/>		
MULTI CH STEREO					<input type="radio"/>	<input type="radio"/>	
VIRTUAL					<input type="radio"/>	<input type="radio"/>	

\*1 Only when "SW Mode" is set to "LFE+Main" (📖 page 6 "Bass Setting"), sound is output from the subwoofer.

\*5 This item can be set when the input signal is analog, PCM 48 kHz or 44.1 kHz.

### Types of input signals, and corresponding surround modes

This table shows the input signal that can be played in each surround mode. Check the audio signal of the input source then select the surround mode.

#### Symbols in the table

- This indicates the default surround mode.
- This indicates the selectable surround mode.

Surround mode (page 18)	NOTE	Input signal types and formats												
		ANALOG	PCM		DTS-HD		DTS			DOLBY		DOLBY DIGITAL		
			PCM (multi ch)	PCM (2ch)	DTS-HD Master Audio	DTS-HD High Resolution Audio	DTS EXPRESS	DTS (5.1ch)	DTS 96/24	DOLBY TrueHD	DOLBY DIGITAL Plus	DOLBY DIGITAL (5.1/5/4ch)	DOLBY DIGITAL (4/3ch)	DOLBY DIGITAL (2ch)
<b>DTS SURROUND</b>														
DTS-HD MSTR					●									
DTS-HD HI RES						●								
DTS SURROUND								●						
DTS 96/24									●					
DTS EXPRESS														
DTS NEO:6 CINEMA		○												○
DTS NEO:6 MUSIC		○												○
<b>DOLBY SURROUND</b>														
DOLBY TrueHD														
DOLBY DIGITAL+														
DOLBY DIGITAL														
DOLBY PRO LOGIC II CINEMA		○												○
DOLBY PRO LOGIC II MUSIC		○												○
DOLBY PRO LOGIC II GAME		○												○
DOLBY PRO LOGIC		○												○
<b>MULTI CH IN</b>														
MULTI CH IN														
<b>DIRECT</b>														
DIRECT		○	○	○	○	○	○	○	○	○	○	○	○	○
<b>DSP SIMULATION</b>														
MULTI CH STEREO		○	○	○					○	○			○	○
VIRTUAL		○	○	○					○	○			○	○
<b>STEREO</b>														
STEREO		●	○	●	○	○	○	○	○	○	○	○	○	○

## Relationship between video signals and monitor output

Input connector		Output connector		HDMI		VIDEO	
		HDMI	VIDEO	Video	Menu	Video	Menu
×	×	×	Only the menu is displayed	×	×		
×	○	×	Only the menu is displayed	○ (VIDEO)	×	○ (VIDEO)	×
○	×	○ <HDMI>	○ <HDMI>	×	×		
○	○	○ <HDMI>	○ <HDMI>	○ (VIDEO)	×	○ (VIDEO)	×
○	×	○ <HDMI>	○ <HDMI>	×	×		

○ Video signal input present

○ < > The input signal between the < > marks is output.

○ ( ) Superimposed on the picture indicated in ( ).

× No video signal input

× No video signal output

× ( ) Only the picture in ( ) is output.

### NOTE

- If you operate the menu while playing back 3D video content or computer's resolution (e.g. VGA), the playback video is replaced by the menu screen. The playback video is not displayed behind the menu screen.
- This unit does not show the status display while playing back 3D video content or computer's resolution (e.g. VGA).

## Explanation of terms

### A

#### **Adobe RGB color, Adobe YCC601 color**

The color space defined by Adobe Systems Inc. Because it is a wider color space than RGB, it can produce more vivid and natural images.

### D

#### **Deep Color**

An imaging technology supported by HDMI. Unlike RGB, which uses 8 bits (256 shades) per color, it can use 10 bits (1024 shades), 12 bits (4096 shades), or 16 bits (65536 shades) to produce colors in higher definition.

Both devices linked via HDMI must support Deep Color.

#### **Dolby Digital**

Dolby Digital is a multi-channel digital signal format developed by Dolby Laboratories.

A total of 5.1 channels are played: 3 front channels ("FL", "FR" and "C"), 2 surround channels ("SL" and "SR") and the "LFE" channel for low frequencies.

Because of this, there is no crosstalk between channels and a realistic sound field with a "three-dimensional" feeling (sense of distance, movement and positioning) is achieved.

A realistic, powerful sense of presence is achieved when playing movie sources in AV rooms as well.

#### **Dolby Digital Plus**

Dolby Digital Plus is an improved Dolby Digital signal format that is compatible with up to 7.1 channels of discrete digital sound and also improves sound quality thanks to extra data bit rate performance. It is upwardly compatible with conventional Dolby Digital, so it offers greater flexibility in response to the source signal and the conditions of the playback device.

#### **Dolby Pro Logic II**

Dolby Pro Logic II is a matrix decoding technology developed by Dolby Laboratories.

Regular music such as that on CDs is encoded into 5 channels to achieve an excellent surround effect. The surround channel signals are converted into stereo and full band signals (with a frequency response of 20 Hz to 20 kHz or greater) to create a "three-dimensional" sound image offering a rich sense of presence for all stereo sources.

#### **Dolby TrueHD**

Dolby TrueHD is a high definition audio technology developed by Dolby Laboratories, using lossless coding technology to faithfully reproduce the sound of the studio master.

This format provides the facility to support up to 8 audio channels with a sampling frequency of 96kHz/24bit resolution and up to 6 audio channels with a sampling frequency of 192kHz/24bit resolution. Dolby TrueHD is adopted for applications that put very high importance on sound quality.

#### **Downmix**

This function converts the number of channels of surround audio to less number of channels and plays back.

#### **DTS**

This is an abbreviation of Digital Theater System, which is a digital audio system developed by DTS. When playing back audio by connecting this system with a device such as DTS amplifier, accurate sound field position and realistic sound effect as if you are in a movie theater can be obtained.

#### **DTS 96/24**

DTS 96/24 is a digital audio format enabling high sound quality playback in 5.1 channels with a sampling frequency of 96 kHz and 24 bit quantization on DVD-Video.

#### **DTS Digital Surround**

DTS Digital Surround is the standard digital surround format of DTS, Inc., compatible with a sampling frequency of 44.1 or 48 kHz and up to 5.1 channels of digital discrete surround sound.

#### **DTS Express**

DTS Express is an audio format supporting low bit rates (max. 5.1 channels, 24 to 256 kbps).

#### **DTS-HD**

This audio technology provides higher sound quality and enhanced functionality than the conventional DTS and is adopted as an optional audio for Blu-ray Disc. This technology supports multi-channel, high data transfer speed, high sampling frequency, and lossless audio playback. Maximum 7.1-channels are supported in Blu-ray Disc.

#### **DTS-HD High Resolution Audio**

DTS-HD High Resolution Audio is an improved version of the conventional DTS, DTS-ES and DTS 96/24 signals formats, compatible with sampling frequencies of 96 or 48 kHz and up to 7.1 channels of discrete digital sound. High data bit rate performance provides high quality sound. This format is fully compatible with conventional products, including conventional DTS digital surround 5.1-channel data.

#### **DTS-HD Master Audio**

DTS-HD Master Audio is a lossless audio format created by Digital Theater System (DTS). This format provides the facility to support up to 8 audio channels with a sampling frequency of 96kHz/24bit resolution and up to 6 audio channels with a sampling frequency of 192kHz/24bit resolution. It is fully compatible with conventional products, including conventional DTS digital surround 5.1-channel data.

#### **DTS NEO:6™ Surround**

DTS NEO:6™ is a matrix decoding technology for achieving 6.1-channel surround playback with 2-channel sources. It includes "DTS NEO:6 Cinema" suited for playing movies and "DTS NEO:6 Music" suited for playing music.

#### **Dynamic range**

The difference between the maximum undistorted sound level and the minimum discernible level above the noise emitted by the device.

### H

#### **HDCP**

When transmitting digital signals between devices, this copyright protection technology encrypts the signals to prevent content from being copied without authorization.

#### **HDMI**

This is an abbreviation of High-Definition Multimedia Interface, which is an AV digital interface that can be connected to a TV or amplifier. Video signal and audio signal can be connected using 1 cable.

### L

#### **LFE**

This is an abbreviation of Low Frequency Effect, which is an output channel that emphasizes low frequency effect sound. Surround audio is intensified by outputting 20 Hz to 120 Hz deep bass.

### M

#### **MP3 (MPEG Audio Layer-3)**

This is an internationally standardized audio data compression scheme, using the "MPEG-1" video compression standard. It compresses the data volume to about one eleventh its original size while maintaining sound quality equivalent to a music CD. **MPEG (Moving Picture Experts Group), MPEG-2, MPEG-4**

These are the names for digital compression format standards used for the encoding of video and audio. Video standards include "MPEG-1 Video", "MPEG-2 Video", "MPEG-4 Visual", "MPEG-4 AVC". Audio standards include "MPEG-1 Audio", "MPEG-2 Audio", "MPEG-4 AAC".

**P****Protection Circuit**

This is a function to prevent damage to devices within the power supply when an abnormality such as an overload, excess voltage occurs or temperature for any reason.

In this unit, the power indicator blinks and the unit enters standby mode when an abnormality occurs.

**S****Sampling frequency**

Sampling involves taking a reading of a sound wave (analog signal) at regular intervals and expressing the height of the wave at each reading in digitized format (producing a digital signal).

The number of readings taken in one second is called the "sampling frequency". The larger the value, the closer the reproduced sound is to the original.

**Speaker impedance**

This is an AC resistance value, indicated in  $\Omega$  (ohms). Greater power can be obtained with this value smaller.

**sYCC601 color**

Like "x.v.Color", each of these color spaces defines a palette of available colors that is larger than the traditional RGB color model.

**W****WMA (Windows Media Audio)**

This is audio compression technology developed by Microsoft Corporation.

WMA data can be encoded using Windows Media® Player Ver.7, 7.1, Windows Media® Player for Windows® XP and Windows Media® Player 9 Series.

To encode WMA files, only use applications authorized by Microsoft Corporation. If you use an unauthorized application, the file may not work properly.

**X****x.v.Color**

This function lets HDTVs display colors more accurately. It enables display with natural, vivid colors. "x.v.Color" is a Sony registered trademark.

# Troubleshooting

If a problem should arise, first check the following:

1. Are the connections correct?



2. Is the set being operated as described in the owner's manual?

3. Are the other devices operating properly?

If this unit does not operate properly, check the items listed in the table below. Should the problem persist, there may be a malfunction.

In this case, disconnect the power immediately and contact your store of purchase.



## [General]

Symptom	Cause/Solution	Page
Power does not turn on.	<ul style="list-style-type: none"> <li>Check whether the power plug is correctly inserted into the power outlet.</li> <li>The protection circuit is active. Disconnect the power plug from the electric outlet, wait 5 to 10 seconds and then insert it back into the outlet.</li> </ul>	 4  <a href="#">51</a>
Power automatically switches to standby mode.	<ul style="list-style-type: none"> <li>The sleep timer is set. Turn on the power again, or change the sleep timer settings.</li> <li>"Auto Standby" is triggered when there is no operation for a set amount of time. To disable "Auto Standby", set "Auto Standby" on the menu to "OFF".</li> </ul>	<a href="#">26</a>  <a href="#">33</a>
Display is off.	<ul style="list-style-type: none"> <li>Press <b>DIMMER</b> and apply any setting except "OFF".</li> </ul>	<a href="#">15</a>
The power indicator is blinking red.	<ul style="list-style-type: none"> <li>The temperature inside the unit has risen. Please turn off power once, and re-apply the power after the temperature has fallen sufficiently.</li> <li>Please re-install this unit in a place having good ventilation.</li> <li>Please use speakers which have the specified impedance.</li> <li>The speaker cable has shorted (is touching). Firmly twist the core wire in the speaker cable, and then re-connect it to the speaker terminal.</li> </ul>	-  -  3, <a href="#">23</a>  3
After turning on the power, the power indicator is blinking red.	<ul style="list-style-type: none"> <li>This unit amplifier circuit has failed. Turn off the power and please contact the DENON service adviser.</li> </ul>	-
Set does not operate properly.	<ul style="list-style-type: none"> <li>Reset the microprocessor.</li> </ul>	<a href="#">54</a>









## [HDMI]

Symptom	Cause/Solution	Page
No audio is output with HDMI connection.	<ul style="list-style-type: none"> <li>Check the connection of the HDMI connectors.</li> <li>When outputting HDMI audio from the speakers, set "HDMI Audio Out" on the menu to "Amp".</li> <li>When outputting HDMI audio from a TV, set "HDMI Audio Out" on the menu to "TV".</li> </ul>	<a href="#">6</a> <a href="#">33</a>  <a href="#">33</a>
No video is output with HDMI connection.	<ul style="list-style-type: none"> <li>Check the connection of the HDMI connectors.</li> <li>Set the input source to match the connected HDMI connector.</li> <li>Check whether the TV is compatible with copyright protection (HDCP). If connected to a device not compatible with HDCP, video will not be output correctly.</li> </ul>	<a href="#">6</a> <a href="#">6, 14</a> <a href="#">8</a>
No audio is output when "Standby Pass" is set.	<ul style="list-style-type: none"> <li>Check the TV settings. Refer to the owner's manual for your TV for more details.</li> <li>Set the speaker to the TV speakers.</li> <li>Set HDMI control to "OFF".</li> </ul>	-

## [Video]

Symptom	Cause/Solution	Page
No picture appears.	<ul style="list-style-type: none"> <li>Check the TV connection.</li> <li>Set the TV input correctly.</li> </ul>	 4  4

**[Audio]**

Symptom	Cause/Solution	Page
Audio is not output.	<ul style="list-style-type: none"> <li>• Check the connections for all devices.</li> <li>• Check the speaker connections and configurations.</li> <li>• Check whether the audio device power is turned on.</li> <li>• Adjust the master volume.</li> <li>• Cancel the mute mode.</li> <li>• Select a suitable input source.</li> <li>• Select a suitable input mode.</li> <li>• Disconnect the headphones. No sound is output from the speakers when headphones are connected.</li> </ul>	 4, <a href="#">6</a> , <a href="#">7</a> , <a href="#">10</a> , <a href="#">11</a> , <a href="#">12</a> , <a href="#">13</a>  3, <a href="#">23</a> , <a href="#">24</a> - <a href="#">14</a> <a href="#">14</a> <a href="#">14</a> <a href="#">31</a> <a href="#">40</a>
The volume does not increase.	<ul style="list-style-type: none"> <li>• The maximum volume is set too low. Set the maximum volume using "Limit" on the menu.</li> <li>• Power for external devices connected to the output connectors of the unit may not be turned on. Check the power of connected external devices.</li> </ul>	<a href="#">32</a> -
No sound is produced from surround speaker.	<ul style="list-style-type: none"> <li>• Check if the surround speakers are connected to the SURROUND terminals.</li> </ul>	-
No sound is produced from subwoofer.	<ul style="list-style-type: none"> <li>• Check the subwoofer connections.</li> <li>• Turn on the subwoofer's power.</li> <li>• Set "Speaker Config." - "Subwoofer" on the menu to "Yes".</li> <li>• If "Front" and "Center" for "Speaker Config." are set to "Large", and "SW Mode" is set to "LFE", no sound may be output from the subwoofers, depending on the input signal or selected surround mode.</li> </ul>	 3, <a href="#">23</a> , <a href="#">24</a>  4  6  5,  6
DTS sound is not output.	<ul style="list-style-type: none"> <li>• Set "Decode Mode" on the menu to "Auto" or "DTS".</li> </ul>	<a href="#">31</a>
Dolby TrueHD, DTS-HD, Dolby Digital Plus audio is not output.	<ul style="list-style-type: none"> <li>• Make HDMI connections.</li> </ul>	<a href="#">6</a>
Dolby PLII mode or DTS NEO:6 mode cannot be selected.	<ul style="list-style-type: none"> <li>• Check that "Speaker Config." - "Center" or "Surround" is set to other than "None". If the speaker system is 2.0/2.1ch, this surround mode cannot be selected.</li> <li>• When headphones are used, Dolby PLII or DTS NEO:6 cannot be selected.</li> </ul>	 5 -
RESTORER cannot be selected.	<ul style="list-style-type: none"> <li>• Check that an analog signal or PCM signal (fs=44.1/48 kHz) is input. For playback of multichannel signals such as Dolby Digital or DTS surround, RESTORER cannot be used.</li> </ul>	<a href="#">37</a>

**[Radio]**

Symptom	Cause/Solution	Page
Reception fails, or there is a lot of noise or distortion.	<ul style="list-style-type: none"> <li>• Change the antenna orientation or position.</li> <li>• Separate the AM loop antenna from the unit.</li> <li>• Use an FM outdoor antenna.</li> <li>• Separate the antenna from other connection cables.</li> </ul>	<a href="#">13</a> <a href="#">13</a> <a href="#">13</a> <a href="#">13</a>

**[Remote Control Unit]**

Symptom	Cause/Solution	Page
The set cannot be operated with the remote control unit.	<ul style="list-style-type: none"> <li>• Batteries are worn out. Replace with new batteries.</li> <li>• Operate the remote control unit within a distance of about 23 ft/7 m from this unit and at an angle of within 30°.</li> <li>• Remove any obstacle between this unit and the remote control unit.</li> <li>• Insert the batteries in the proper direction, checking the ⊕ and ⊖ marks.</li> <li>• The set's remote control sensor is exposed to strong light (direct sunlight, inverter type fluorescent bulb light, etc.). Move the set to a place in which the remote control sensor will not be exposed to strong light.</li> </ul>	<a href="#">44</a> <a href="#">44</a> <a href="#">44</a> <a href="#">44</a> <a href="#">44</a>



## Resetting the microprocessor

Perform this procedure if the display is abnormal or if operations cannot be performed. When the microprocessor is reset, all the settings are reset to their default values.

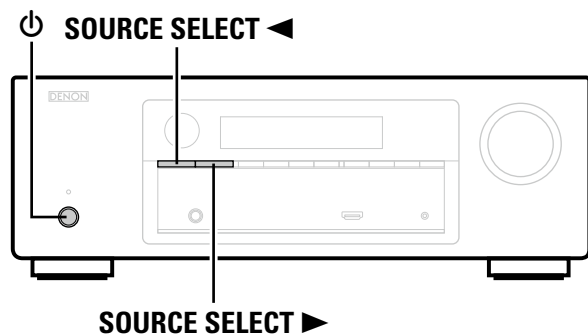

- 1** Turn off the power using ⏻.
- 2** Press ⏻ while simultaneously pressing SOURCE SELECT ◀ and SOURCE SELECT ▶.
- 3** Once the display starts flashing at intervals of about 1 second, release the two buttons.



If in step 3 the display does not flash at intervals of about 1 second, start over from step 1.

## Specifications

### ❑ Audio section

- **Power amplifier**  
Rated output:

Front:  
75 W + 75 W (8 Ω, 20 Hz – 20 kHz with 0.08 % T.H.D.)  
110 W + 110 W (6 Ω, 1 kHz with 0.7 % T.H.D.)

Center:  
75 W (8 Ω, 20 Hz – 20 kHz with 0.08 % T.H.D.)  
110 W (6 Ω, 1 kHz with 0.7 % T.H.D.)

Surround:  
75 W + 75 W (8 Ω, 20 Hz – 20 kHz with 0.08 % T.H.D.)  
110 W + 110 W (6 Ω, 1 kHz with 0.7 % T.H.D.)

6 – 16 Ω

#### Output connectors:

- **Analog**

**Input sensitivity/Input impedance:**

200 mV/47 kΩ

**Frequency response:**

10 Hz – 100 kHz — +1, –3 dB (DIRECT mode)

**S/N:**

98 dB (IHF–A weighted, DIRECT mode)

### ❑ Video section

- **Standard video connectors**

**Input/output level and impedance:**

1 V<sub>p-p</sub>, 75 Ω

**Frequency response:**

5 Hz – 10 MHz — 0, –3 dB

### ❑ Tuner section

**Receiving Range:**

(Note: μV at 75 Ω, 0 dBf = 1 × 10<sup>-15</sup> W)

87.5 MHz – 107.9 MHz

[AM]

520 kHz – 1710 kHz

**Usable Sensitivity:**

1.2 μV (12.8 dBf)

18 μV

**50 dB Quieting Sensitivity:**

MONO 2.8 μV (20.2 dBf)

**S/N:**

MONO 70 dB (IHF–A weighted, DIRECT mode)

STEREO 67 dB (IHF–A weighted, DIRECT mode)

**Total harmonic Distortion (at 1 kHz):**

MONO 0.7 % (1 kHz)

STEREO 1.0 % (1 kHz)

### ❑ General

**Power supply:**

AC 120 V, 60 Hz

**Power consumption:**

330 W

0.5 W (Standby)

For purposes of improvement, specifications and design are subject to change without notice.

## Index

### Numerics

2.1-channel	22, 24
3D	8
5.1-channel	22, 23

### A

Accessories	1
Adjusting the master volume	14
Adobe RGB color / Adobe YCC601 color	8, 50
AM loop antenna	13
Audio Adjust	34
Audio Delay	37
Auto Preset	31
Auto Standby	33

### B

Bass	36
Bass Setting	27

### C

Cable	
Audio cable	9
Coaxial digital cable	9
HDMI cable	6, 7
Optical cable	9
Speaker cable	23
Stereo mini plug cable	9
Video cable	9
Center Image	35
Center Width	35
Channel Level	25, 27
Condensation	2
Connection	
Antenna	13
Blu-ray Disc player	7, 12
Cable TV	7, 11
Digital camcorder	7
DVD player	7, 12
Game console	7
HDMI	6, 7
Portable player	13
Satellite tuner	7, 11
Set-top box	7, 11
Speaker	23
TV	6, 10
Crossover Freq.	27

### D

D.Comp	35
Decode Mode	31
Deep Color	8, 50
Dimension	35
Display	41
Distance	27
Dolby	
Dolby Digital	19, 50
Dolby Digital Plus	19, 50
Dolby Pro Logic II	19, 50
Dolby TrueHD	19, 50
Downmix	50
DRC	35
DTS	19, 50
DTS 96/24	19, 50
DTS Digital Surround	50
DTS Express	50
DTS-HD	19, 50
DTS-HD High Resolution Audio	50
DTS-HD Master Audio	50
DTS NEO:6™ Surround	19, 50
Dynamic range	50

### F

Fader function	25
FM/AM	16
FM indoor antenna	13
Front Panel	40

### H

HDCP	8, 50
HDMI	5, 8, 33, 50
HDMI Audio Out	33
Headphones	40

### I

Information	38
Input Assign	30
Input Mode	31
Input Setup	29
Input signal	19, 48

### L

LFE	34, 50
Limit	32
Listening mode	18

### M

Menu map	27
Mode	34
MP3	37, 50
MPEG	37, 50
Mute Level	32

### N

NIGHT MODE	36
------------	----

### O

Option Setup	32
HDMI	33
Other	33
Volume	32

### P

Panorama	35
Playback	
Blu-ray Disc player	15
Direct	20
DVD player	15
FM/AM	16
Multi channel stereo	20
Portable player	15
Standard	19
Stereo	20
Virtual	20
Power On Level	32
Preset Skip	31
Presetting radio stations	16
Protection circuit	23, 51

### Q

Quick select	26
--------------	----

### R

Rear panel	42
Remote control unit	43
Inserting the batteries	44
Resetting the microprocessor	54
RESTORER	37

### S

Sampling frequency	51
Scale	32
Selecting the input source	14
Setup Lock	33
Sleep timer	26
Source Level	31
Speaker	
Connect	23
Install	22
Speaker Config.	27
Speaker impedance	23, 51
Speaker Setup	27
Standby Pass	33
Subwoofer	35
Surround Mode	18, 46
Switching the brightness of the display	15
sYCC601 color	8, 51

### T

Tone	36
Trademark	45
Treble	36
Troubleshooting	52
Turning off the sound temporarily	14

### V

Video Source	31
Volume	32

### W

WMA	37, 51
-----	--------

### X

x.v.Color	8, 51
-----------	-------

# Dimensions

Unit : in. (mm)

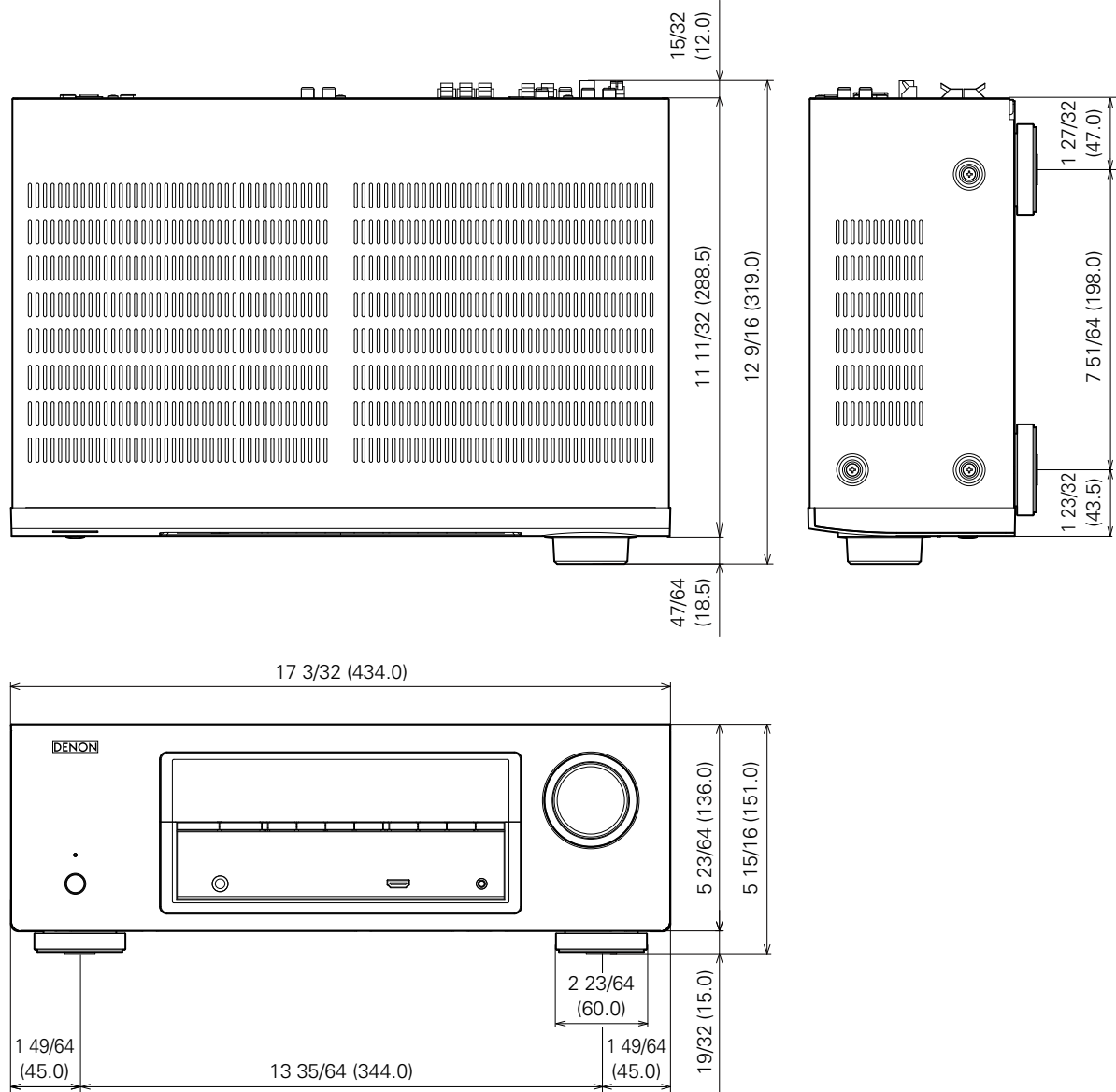

**Weight : 17 lbs 3.1 oz (7.8 kg)**

