

DENON

AV SURROUND RECEIVER

AVR-590

Owner's Manual

Manuel de l'Utilisateur

- ※ The illustrations used for explaining operations in this manual show the buttons of the remote control unit.
The same operations can be performed using the buttons with the same names on the main unit panel.
- ※ Les illustrations des boutons présentes dans ce manuel servent à expliquer le fonctionnement de la télécommande.
Vous pouvez contrôler l'appareil à l'aide du bouton portant le même nom sur la façade de l'appareil.

SAFETY PRECAUTIONS



CAUTION
RISK OF ELECTRIC SHOCK
DO NOT OPEN



CAUTION:
TO REDUCE THE RISK OF ELECTRIC SHOCK, DO NOT REMOVE COVER (OR BACK). NO USER-SERVICEABLE PARTS INSIDE. REFER SERVICING TO QUALIFIED SERVICE PERSONNEL.

The lightning flash with arrowhead symbol, within an equilateral triangle, is intended to alert the user to the presence of uninsulated "dangerous voltage" within the product's enclosure that may be of sufficient magnitude to constitute a risk of electric shock to persons.

The exclamation point within an equilateral triangle is intended to alert the user to the presence of important operating and maintenance (servicing) instructions in the literature accompanying the appliance.

WARNING:
TO REDUCE THE RISK OF FIRE OR ELECTRIC SHOCK, DO NOT EXPOSE THIS APPLIANCE TO RAIN OR MOISTURE.



CAUTION:
HOT SURFACE. DO NOT TOUCH.
 The top surface over the internal heat sink may become hot when operating this product continuously.

PRECAUTION:
SURFACE CHAUDE. NE PAS TOUCHER.
 La surface supérieure du dissipateur de chaleur peut devenir chaude si vous utilisez ce produit en continu.

IMPOTANT SAFETY INSTRUCTIONS

1. Read these instructions.
2. Keep these instructions.
3. Heed all warnings.
4. Follow all instructions.
5. Do not use this apparatus near water.
6. Clean only with dry cloth.
7. Do not block any ventilation openings. Install in accordance with the manufacturer's instructions.
8. Do not install near any heat sources such as radiators, heat registers, stoves, or other apparatus (including amplifiers) that produce heat.
9. Do not defeat the safety purpose of the polarized or grounding-type plug. A polarized plug has two blades with one wider than the other. A grounding type plug has two blades and a third grounding prong. The wide blade or the third prong are provided for your safety. If the provided plug does not fit into your outlet, consult an electrician for replacement of the obsolete outlet.
10. Protect the power cord from being walked on or pinched particularly at plugs, convenience receptacles, and the point where they exit from the apparatus.
11. Only use attachments/accessories specified by the manufacturer.
12. Use only with the cart, stand, tripod, bracket, or table specified by the manufacturer, or sold with the apparatus. When a cart is used, use caution when moving the cart/apparatus combination to avoid injury from tip-over.
13. Unplug this apparatus during lightning storms or when unused for long periods of time.
14. Refer all servicing to qualified service personnel. Servicing is required when the apparatus has been damaged in any way, such as power-supply cord or plug is damaged, liquid has been spilled or objects have fallen into the apparatus, the apparatus has been exposed to rain or moisture, does not operate normally, or has been dropped.
15. Batteries shall not be exposed to excessive heat such as sunshine, fire or the like.



CAUTION:

- The ventilation should not be impeded by covering the ventilation openings with items, such as newspapers, tablecloths, curtains, etc.
- No naked flame sources, such as lighted candles, should be placed on the unit.
- Observe and follow local regulations regarding battery disposal.
- Do not expose the unit to dripping or splashing fluids.
- Do not place objects filled with liquids, such as vases, on the unit.

ATTENTION:

- La ventilation ne doit pas être gênée en recouvrant les ouvertures de la ventilation avec des objets tels que journaux, rideaux, tissus, etc.
- Aucune flamme nue, par exemple une bougie, ne doit être placée sur l'appareil.
- Veillez à respecter les lois en vigueur lorsque vous jetez les piles usagées.
- L'appareil ne doit pas être exposé à l'eau ou à l'humidité.
- Ne pas poser d'objet contenant du liquide, par exemple un vase, sur l'appareil.

CAUTION:

To completely disconnect this product from the mains, disconnect the plug from the wall socket outlet. The mains plug is used to completely interrupt the power supply to the unit and must be within easy access by the user.

PRECAUTION:

Pour déconnecter complètement ce produit du courant secteur, débranchez la prise de la prise murale. La prise secteur est utilisée pour couper complètement l'alimentation de l'appareil et l'utilisateur doit pouvoir y accéder facilement.

FCC INFORMATION (For US customers)

1. PRODUCT

This product complies with Part 15 of the FCC Rules. Operation is subject to the following two conditions: (1) this product may not cause harmful interference, and (2) this product must accept any interference received, including interference that may cause undesired operation.

2. IMPORTANT NOTICE: DO NOT MODIFY THIS PRODUCT

This product, when installed as indicated in the instructions contained in this manual, meets FCC requirements. Modification not expressly approved by DENON may void your authority, granted by the FCC, to use the product.

3. NOTE

This product has been tested and found to comply with the limits for a Class B digital device, pursuant to Part 15 of the FCC Rules. These limits are designed to provide reasonable protection against harmful interference in a residential installation.

This product generates, uses and can radiate radio frequency energy and, if not installed and used in accordance with the instructions, may cause harmful interference to radio communications. However, there is no guarantee that interference will not occur in a particular installation. If this product does cause harmful interference to radio or television reception, which can be determined by turning the product OFF and ON, the user is encouraged to try to correct the interference by one or more of the following measures:

- Reorient or relocate the receiving antenna.
- Increase the separation between the equipment and receiver.
- Connect the product into an outlet on a circuit different from that to which the receiver is connected.
- Consult the local retailer authorized to distribute this type of product or an experienced radio/TV technician for help.

This Class B digital apparatus complies with Canadian ICES-003.
Cet appareil numérique de la classe B est conforme à la norme NMB-003 du Canada.

NOTE ON USE / OBSERVATIONS RELATIVES A L'UTILISATION

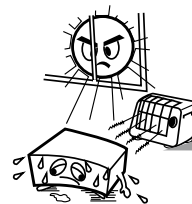

- Avoid high temperatures. Allow for sufficient heat dispersion when installed in a rack.
- Eviter des températures élevées. Tenir compte d'une dispersion de chaleur suffisante lors de l'installation sur une étagère.



- Keep the unit free from moisture, water, and dust.
- Protéger l'appareil contre l'humidité, l'eau et la poussière.

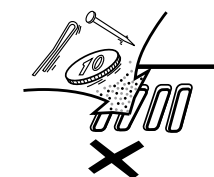

- Do not let foreign objects into the unit.
- Ne pas laisser des objets étrangers dans l'appareil.

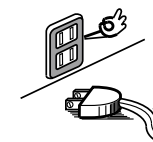

- Unplug the power cord when not using the unit for long periods of time.
- Débrancher le cordon d'alimentation lorsque l'appareil n'est pas utilisé pendant de longues périodes.

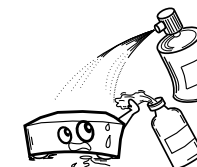

- Do not let insecticides, benzene, and thinner come in contact with the unit.
- Ne pas mettre en contact des insecticides, du benzène et un diluant avec l'appareil.

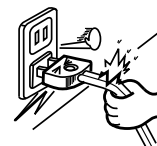

- Handle the power cord carefully. Hold the plug when unplugging the cord.
- Manipuler le cordon d'alimentation avec précaution. Tenir la prise lors du débranchement du cordon.

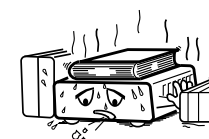

* (For apparatuses with ventilation holes)

- Do not obstruct the ventilation holes.
- Ne pas obstruer les trous d'aération.



- Never disassemble or modify the unit in any way.
- Ne jamais démonter ou modifier l'appareil d'une manière ou d'une autre.

■ Contents

Getting Started	
Flow of operations through playback	2
Accessories	2
Cautions on Handling	3
Cautions on Installation	3
About the Remote Control Unit	3
Inserting the Batteries	3
Operating Range of the Remote Control Unit	3
Part Names and Functions	4
Front Panel	4
Display	5
Rear Panel	6
Remote Control Unit	7
Connections	
Important Information	8
Cables Used for Connections	8
Converting Input video signals for Output (Video Conversion Function)	9
How the on-screen display is displayed depending on the video input signal	9
Installing/Setting the Speakers	10
Connecting the Speakers	11
Connecting Devices	12
Connecting Devices not Equipped with HDMI connectors	13
Once Connections are Completed	16
Turning the Power On	16
Turning the Power Off	16
Settings	
Menu map	17
Examples of On-screen Display and Front Display	18
Making the Optimum Settings for the Connected Speakers Automatically (Audyssey Auto Setup)	19
Making detailed settings (Manual Setup)	24
Making the input settings (Input Setup)	30

Playback	
Playing Components	34
Playing Blu-ray Disc / DVD Players	34
iPod® Playback	34
Listening to FM/AM Broadcasts	36
Operations During Playback	37
Selecting the Surround Mode	37
① Playing sources according to the sources' audio signal format/number of channels (Standard Playback)	37
② Playing in a DENON original surround mode	38
③ Direct Playback	38
④ Stereo Playback	39
Adjusting the Sound Field Effects (Parameter)	39
Adjusting the sound field effects (Surround Parameter)	39
Adjusting the tone (Tone Control)	41
Making the MultEQ, Dynamic EQ and Dynamic Volume settings (Audyssey Settings)	41
Adjust tonal quality for each speaker using graphic equalizer (Manual EQ)	42
Restoring compressed audio to nearly pre-compressed conditions for playback (RESTORER)	43
Adjusting the audio delay time while watching the picture (Audio Delay)	43
Checking the Status (Information)	
Checking the Status (Information)	43
Convenient functions	
HDMI Control Function	44
Setting the power to standby after a certain amount of time (Sleep Timer Function)	44
Playing the picture of a different input source without changing the currently playing sound (Video Select Function)	44
Adjust the volume of the different speakers	45
Saving frequently used settings (Quick Select Function)	45
Various memory functions	45

Operating the Connected Devices by Remote Control Unit	
Registering Preset Codes	46
Operating Registered Devices	46
Assigning buttons that are Not Used to Operate Other Devices (Punch Through Function)	48
Other Information	
Other Information	49
Troubleshooting	
Troubleshooting	55
Restoring all the settings to as they were at the time of purchase (Resetting the Microprocessor)	57
Specifications	
Specifications	58
List of preset codes	
List of preset codes	End of this manual

Getting Started

Flow of operations through playback

Perform the operations leading to playback on the AVR-590 in the order shown below.

Connections

Installing/Setting the Speakers (☞ page 10)



Connecting the Speakers (☞ page 11)



Connecting Devices (☞ page 12)



Turning the Power On (☞ page 16)



Settings

Audyssey Auto Setup (☞ page 19)



Manual Setup (☞ page 24)

※ Perform "Manual Setup" as necessary.



Input Setup (☞ page 30)



Playback

Playing Components (☞ page 34)



Selecting the Surround Mode (☞ page 37)



Adjusting the Sound Field Effects (☞ page 39)

Thank you for purchasing this DENON product. To ensure proper operation, please read this owner's manual carefully before using the product.

After reading them, be sure to keep them for future reference.

Accessories

Check that the following parts are supplied with the product.

① Owner's manual	1
② Getting Started	1
③ Warranty (for North America model only)	1
④ Service station list	1
⑤ Remote control (RC-1120)	1
⑥ R03/AAA batteries	2
⑦ FM indoor antenna	1
⑧ AM loop antenna	1
⑨ Setup microphone (DM-A409, Cord length: Approx. 25 ft / 7.6 m)	1

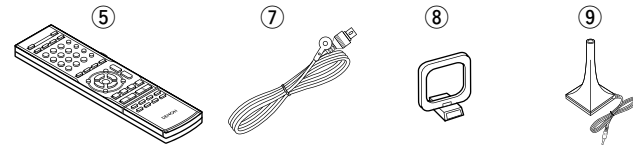

Cautions on Handling

- Before turning the power switch on**
 Check once again that all connections are correct and that there are no problems with the connection cables.
- Power is supplied to some of the circuitry even when the unit is set to the standby mode. When traveling or leaving home for long periods of time, be sure to unplug the power cord from the power outlet.
- About condensation**
 If there is a major difference in temperature between the inside of the unit and the surroundings, condensation (dew) may form on the operating parts inside the unit, causing the unit not to operate properly.
 If this happens, let the unit sit for an hour or two with the power turned off and wait until there is little difference in temperature before using the unit.
- Cautions on using mobile phones**
 Using a mobile phone near this unit may result in noise. If so, move the mobile phone away from this unit when it is in use.
- Moving the unit**
 Turn off the power and unplug the power cord from the power outlet.
 Next, disconnect the connection cables to other system units before moving the unit.
- Note that the illustrations in these instructions may differ from the actual unit for explanation purposes.

Cautions on Installation

Note:
For proper heat dispersal, do not install this unit in a confined space, such as a bookcase or similar enclosure.

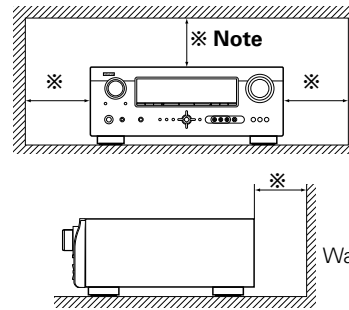

About the Remote Control Unit

In addition to the AVR-590, the included remote control unit (RC-1120) can also be used to operate the equipment listed below.

- DENON system components**
- Non-DENON system components**
 - By setting the preset memory (page 46)

Inserting the Batteries

- Lift the clasp and remove the rear cover.
- Load the two batteries properly as indicated by the marks in the battery compartment.

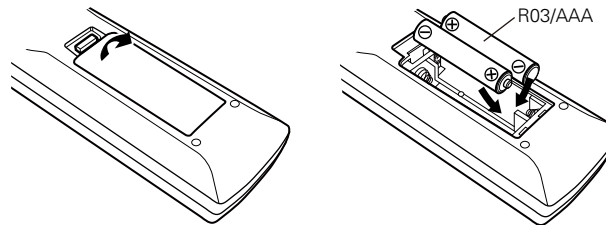

- Put the rear cover back on.

NOTE

- Replace the batteries with new ones if the set does not operate even when the remote control unit is operated close to the unit.
- The supplied batteries are only for verifying operation.
- When inserting the batteries, be sure to do so in the proper direction, following the "⊕" and "⊖" marks in the battery compartment.
- To prevent damage or leakage of battery fluid:
 - Do not use a new battery together with an old one.
 - Do not use two different types of batteries.
 - Do not attempt to charge dry batteries.
 - Do not short-circuit, disassemble, heat or dispose of batteries in flames.
- If the battery fluid should leak, carefully wipe the fluid off the inside of the battery compartment and insert new batteries.
- Remove the batteries from the remote control unit if it will not be in use for long periods.
- Used batteries should be disposed of in accordance with the local regulations regarding battery disposal.

Operating Range of the Remote Control Unit

Point the remote control unit at the remote sensor when operating it.

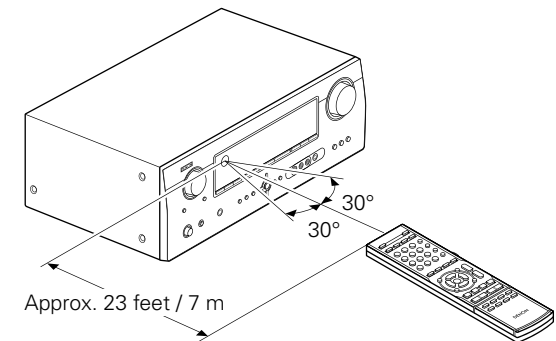

NOTE

The set may function improperly or the remote control unit may not operate if the remote control sensor is exposed to direct sunlight, strong artificial light from an inverter type fluorescent lamp or infrared light.

Part Names and Functions

Front Panel

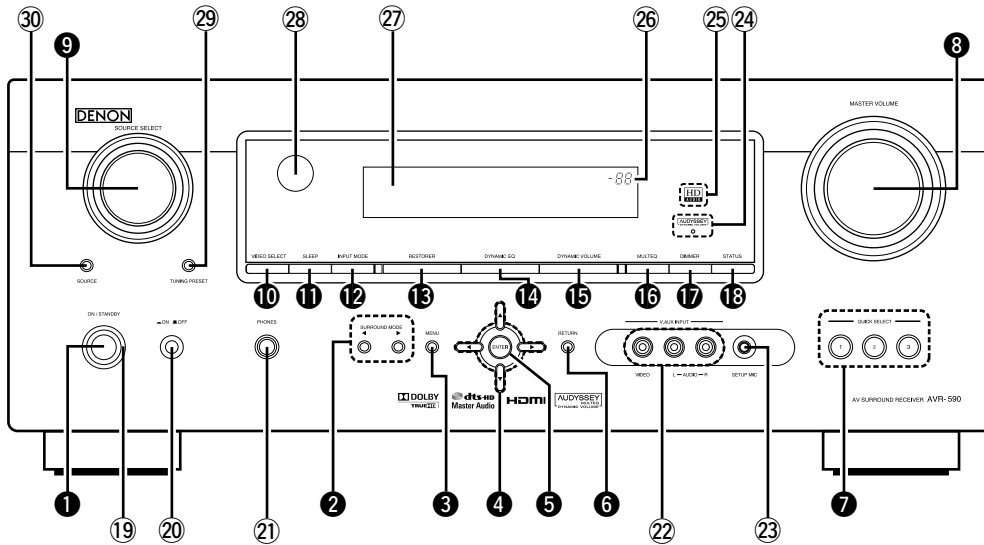

Buttons, connectors and displays only provided on the main unit

- 19 Power indicator (16)
- 20 Power switch (ON/OFF) (16, 57)
- 21 Headphones jack (PHONES) (37)
- 22 V. AUX INPUT connectors (15)
- 23 SETUP MIC jack (20)
- 24 AUDYSSEY DYNAMIC VOLUME indicator (42)
- 25 HD AUDIO indicator (38)
- 26 MASTER VOLUME indicator (38)
- 27 Display
- 28 Remote control sensor (3)
- 29 TUNING PRESET button (36)
- 30 SOURCE MODE SELECT button (34)

Button that function in the same way as remote control buttons

For buttons not explained here, see the page indicated in parentheses ().

- 1 Power operation button (ON/STANDBY) (16)
- 2 SURROUND MODE buttons (37)
- 3 MENU button (17)
- 4 Cursor buttons (△▽◀▶) (17)
- 5 ENTER button (17)
- 6 RETURN button (17)
- 7 QUICK SELECT buttons (45)
- 8 MASTER VOLUME control knob (34)
- 9 SOURCE SELECT knob (34)
- 10 VIDEO SELECT button (44)
- 11 SLEEP TIMER button (44)
- 12 INPUT MODE button (32)
- 13 RESTORER button (43)
- 14 DYNAMIC EQ button (42)
- 15 DYNAMIC VOLUME button (42)
- 16 MULTEQ button (41)
- 17 DIMMER button (37)
- 18 STATUS button (43)

Buttons that function in the same way as Front Panel buttons

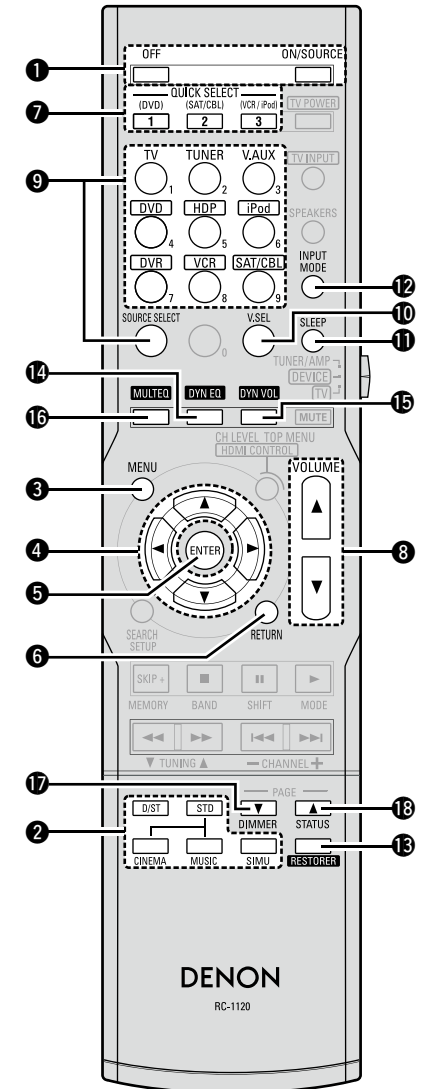

Display

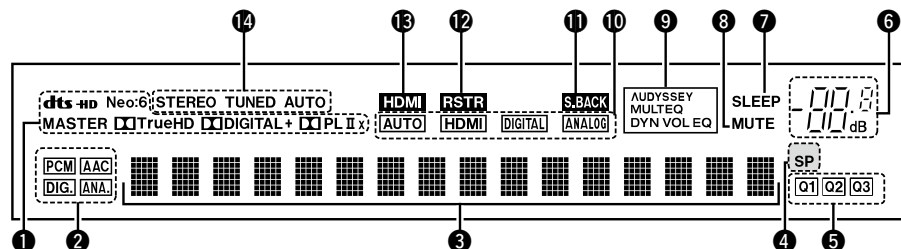

1 Decoder indicators

The indicator for the currently operating decoder lights.

2 Input audio signal indicators

3 Information display

The input source name, surround mode, setting values and other information are displayed here.

4 Front speaker indicator

Lights when audio signals are being output from the speakers.

5 QUICK SELECT indicators

These light when the Quick Select function is set (page 45).

6 Master volume indicator

When performing setting operations, displays the menu number.

7 SLEEP TIMER indicator

Lights when the sleep timer is operating (page 44).

8 MUTE indicator

Lights when the muting mode is set (page 37).

9 AUDYSSEY indicator

These light as shown below in the different modes (page 41).

AUDYSSEY MULTEQ : During "MultEQ" operation

AUDYSSEY MULTEQ DYN EQ : During "MultEQ", "Dynamic EQ" operation

AUDYSSEY MULTEQ DYN VOL : During "MultEQ", "Dynamic EQ", "Dynamic Volume" operation

※When speaker settings are changed after the Audyssey Auto Setup procedure, either the indicators' frame turns off or all the indicators turn off.

10 Input mode indicators

11 S.BACK indicator

Lights when surround back audio signals are being output from the SURR. BACK / FRONT HEIGHT PRE OUT connectors (page 25).

12 RESTORER indicator

Lights during "RESTORER" operation (page 43).

13 HDMI indicator

Lights when HDMI input signals are detected (page 13).

14 Tuner reception mode indicators

This lights according to the reception conditions when the input source is set to "TUNER".

• **AUTO**

This lights when in the auto tuning mode.

• **STEREO**

In the FM mode, this lights when receiving analog stereo broadcasts.

• **TUNED**

This lights when the broadcast is properly tuned in.

Rear Panel

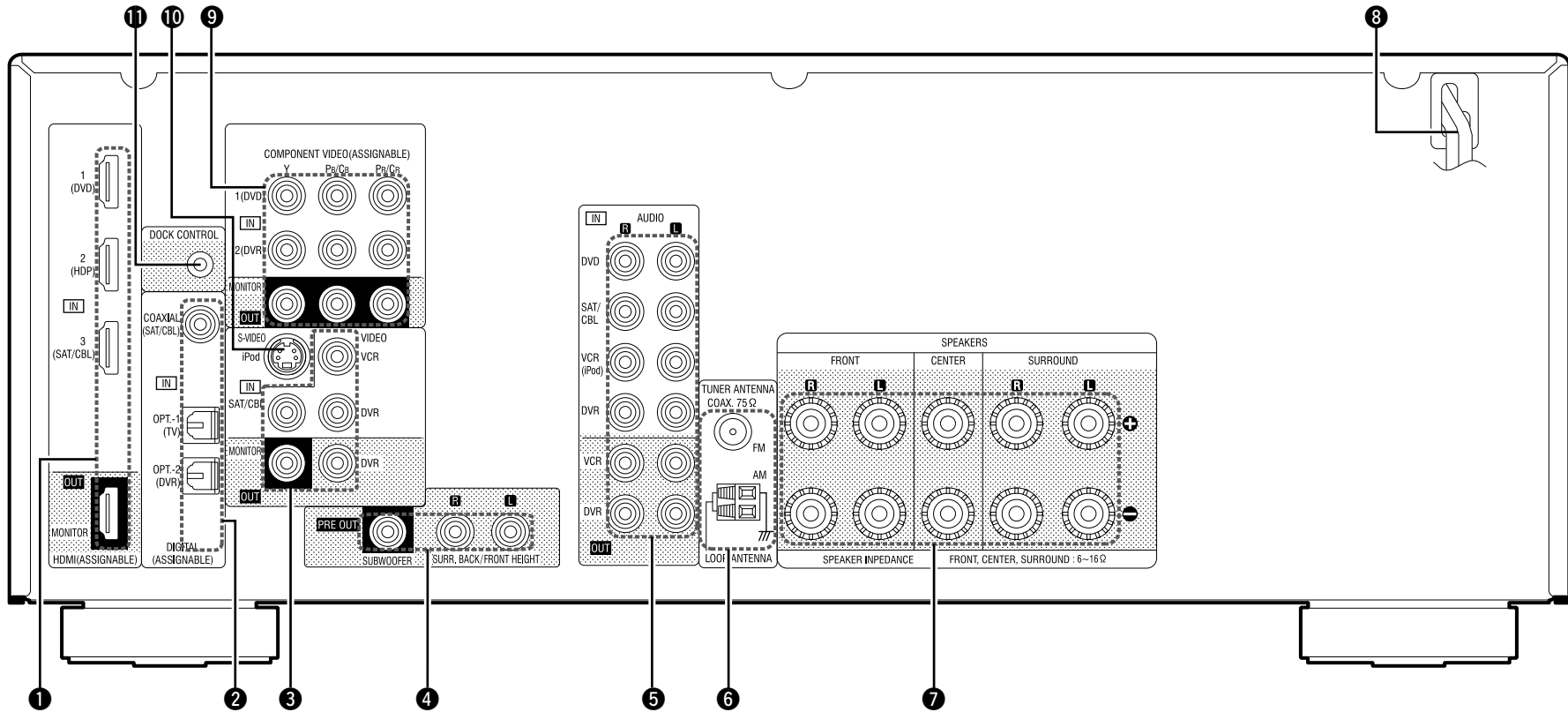

- | | | |
|---------------------------------------|--------------------------------------|---|
| 1 HDMI connectors (13) | 5 Analog audio connectors (14) | 9 COMPONENT VIDEO connectors (14) |
| 2 Digital audio connectors (14) | 6 FM/AM antenna terminals (16) | 10 Control Dock for iPod S-Video input connector (14) |
| 3 VIDEO connectors (15) | 7 Speaker terminals (11) | 11 Control Dock for iPod DOCK CONTROL jack (14) |
| 4 PRE OUT connectors (11) | 8 Power cord (16) | |

Remote Control Unit

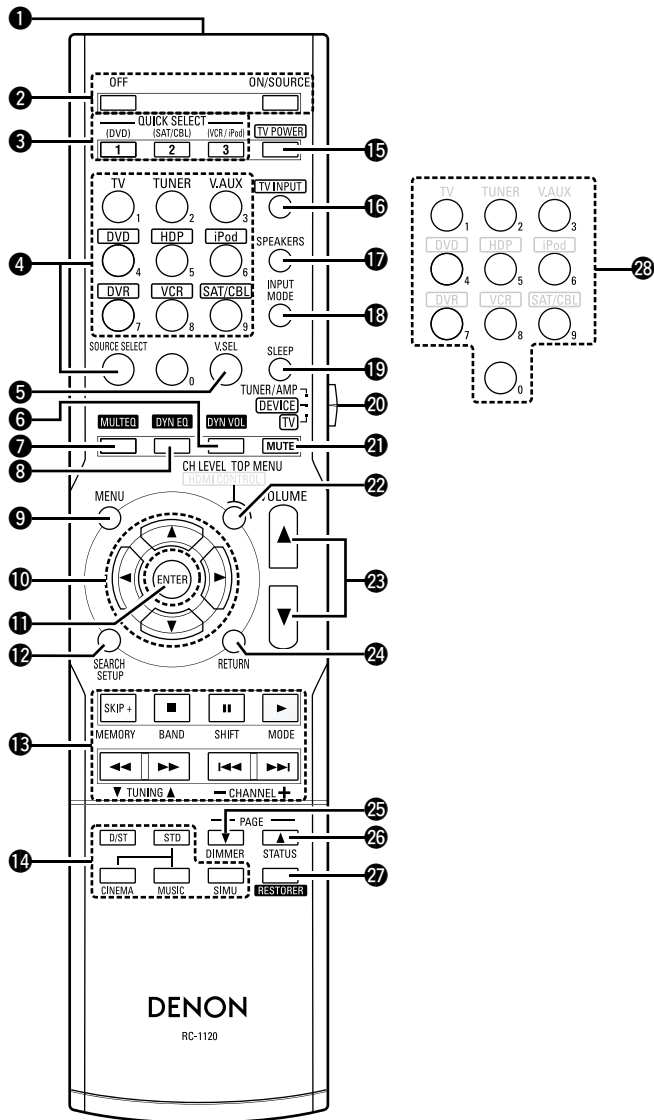

- ➊ Remote control signal transmitter
- ➋ Power buttons (16)
- ➌ QUICK SELECT buttons (45)
- ➍ SOURCE SELECT buttons (34)
- ➎ VIDEO SELECT button (44)
- ➏ DYNAMIC VOLUME button (42)
- ➐ MULTEQ button (41)
- ➑ DYNAMIC EQ button (42)
- ➒ MENU button (17)
- ➓ Cursor buttons (△▽◀▶) (17)
- ➑ ENTER button (17)
- ➒ SEARCH button (35)
- ➓ System buttons (46)
- ➑ Surround mode buttons (37)
- ➒ TV POWER button (47)
- ➓ TV INPUT button (47)
- ➑ FRONT HEIGHT SPEAKER ON/OFF button (41)
- ➒ INPUT MODE button (32)
- ➓ SLEEP button (44)
- ➑ Device select switch (34, 46)
- ➒ MUTING button (37)
- ➓ Channel level adjustment button (45)
- ➑ Master volume control buttons (34)
- ➒ RETURN button (17)
- ➓ DIMMER button (37)
- ➑ STATUS button (43)
- ➒ RESTORER button (43)
- ➓ Number buttons (0 ~ 9) (46)



For buttons not explained here, see the page indicated in parentheses ().

Operations possible by remote control

❑ Operations on the AVR-590

❑ Operations on six devices other than the AVR-590
 Preset the remote control codes of the devices to be operated beforehand (☞ page 46).

① Switch the **DEVICE SELECT** switch according to the device to be operated.

② Press the **SOURCE SELECT** button for the device to be operated.

※ For detailed operating instructions, see "Operating registered devices" (☞ page 46).

① DEVICE SELECT switch	② SOURCE SELECT button	Operable devices
TUNER/AMP	—	AVR-590 and Tuner
DEVICE	DVD	DVD Player or CD player
	HDP	Blu-ray disc player
	iPod	iPod (DENON)
	DVR	Digital video recorder
	VCR	Video deck
	SAT/CBL	Satellite receiver or Cable TV
TV	TV	TV

❑ Punch through setting (☞ page 48)

Connections

Connection Flow

Installing/Setting the Speakers (page 10)



Connecting the Speakers (page 11)



Connecting Devices (page 12)



Connecting Devices not Equipped with HDMI connectors (page 13)

HDMI (page 12)

Monitor (TV) (page 13)

Playback Components

- Blu-ray Disc player / DVD player (page 14)
- iPod® (page 14)

SAT/CABLE Tuner (page 14)

Recording Components

- DVD Recorder (page 15)
- Video Cassette Recorder (page 15)

Other Devices

- Video Camera / Game Console (page 15)
- Antenna terminals (page 16)

Power Cord



Turning the Power On (page 16)

Important Information

Connections for all compatible audio and video signal formats are described in this owner's manual. Please select the types of connections suited for the equipment you are connecting.













After connections are completed, certain settings must be made on the receiver. Make the settings indicated "Set as necessary" for the individual items.

NOTE

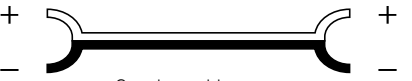
- Do not plug in the power cord until all connections have been completed.
- When making connections, also refer to the operating instructions of the other components.
- Be sure to connect the left and right channels properly (left with left, right with right).
- Do not bundle power cords together with connection cables. Doing so can result in humming or noise.

Cables Used for Connections

Select the cables according to the equipment being connected.

Audio and video cables	
HDMI connections	 HDMI cable
Audio cables	
Coaxial digital connections	 Coaxial digital cable
Optical digital connections	 Optical cable
Analog connections	(White)  (Red)  Stereo pin-plug cable
Analog connections (monaural, for subwoofer)	 Pin-plug cable
Speaker connections	 Speaker cables
Video cables	
Component video connections	(Green)  (Blue)  (Red)  Component video cable
S-Video connections	 S-Video cable
Video connections	(Yellow)  75 Ω/ohms pin-plug video cable

Converting Input video signals for Output (Video Conversion Function)

The AVR-590 is equipped with four types of video input connectors (HDMI, Component video, S-Video and video) and three types of video output connectors (HDMI, Component video and video). Use the connectors according to the devices to be connected.

This function automatically converts various formats of video signals input to the AVR-590 into the format used to output the video signals from the AVR-590 to a monitor.

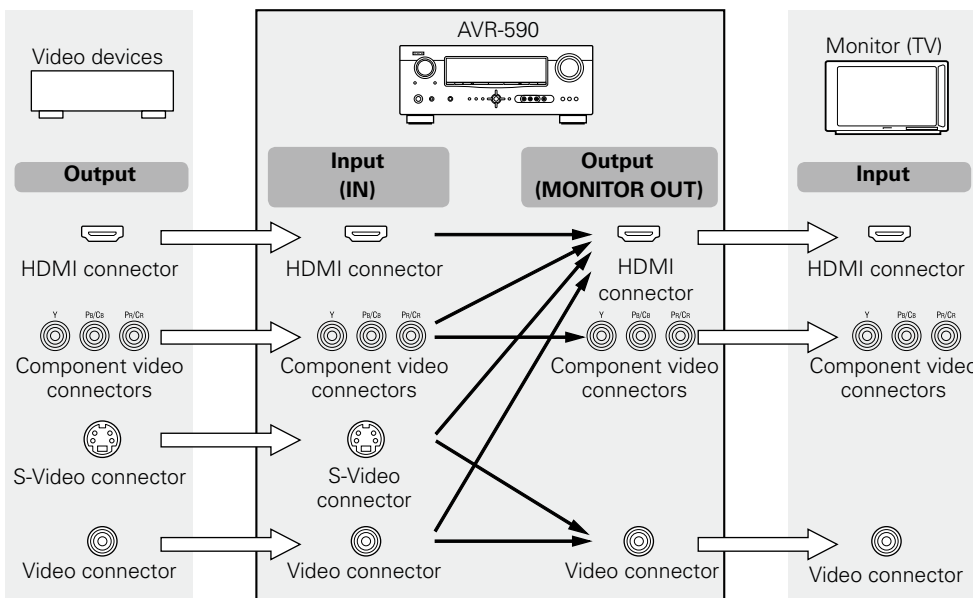

The video conversion function supports the NTSC, PAL, SECAM, NTSC 4.43, PAL-N, PAL-M and PAL-60 formats.

NOTE

- The S-Video input connector is exclusively for use with a Control Dock for iPod. It can be used when the Control Dock for iPod is connected to the connector assigned to the iPod input source.
- HDMI signals cannot be converted into analog signals.
- When a non-standard video signal from a game machine or some other source is input, the video conversion function might not operate.

How the on-screen display is displayed depending on the video input signal

The way the on-screen display of the menus, status, etc., is displayed differs according to the type of video signal input to the AVR-590.

When video signals are input from the HDMI or component video connectors

- **Menu:** Switches to a screen with a black background and the menu is superimposed. (※)
- **Status display:** Not displayed.

※: If you want to display the menu superimposed on the picture being played, input the same video signals to the S-Video or video connectors. When a menu is displayed, the picture switches to the one being input from the S-Video or video connectors and the menu is displayed superimposed over this picture.

NOTE

Menus and status display screens are not displayed for component video connector pictures. To display them, also connect the video connectors.

When video signals are being input from the S-Video or video connectors

- **Menu:** Menus are displayed superimposed over the picture being played.
- **Status display:** Displayed.

Examples of on-screen display

- Menu screen
- Status display screen
 - When the input source is switched
 - When the volume is adjusted

```
MENU
1. Parameter
2. Information
3. Auto Setup
4. Manual Setup
5. Input Setup

[ENT] : Select
```

```
[Auto]
IN : DVD
MODE : STEREO
```

```
Master Volume -80.0dB
```

Status display: The operating status is displayed temporarily on the screen when the input source is switched or the volume is adjusted.

Installing/Setting the Speakers

- The AVR-590 is compatible with various types of surround playback.
- Decide on the surround modes to be played on the AVR-590 before making connections and settings.

1 Determine the Speaker Layout.

Below we introduce examples of speaker layouts. Refer to these to arrange your speakers according to their type and how you want to use them.

Installing All the Speakers

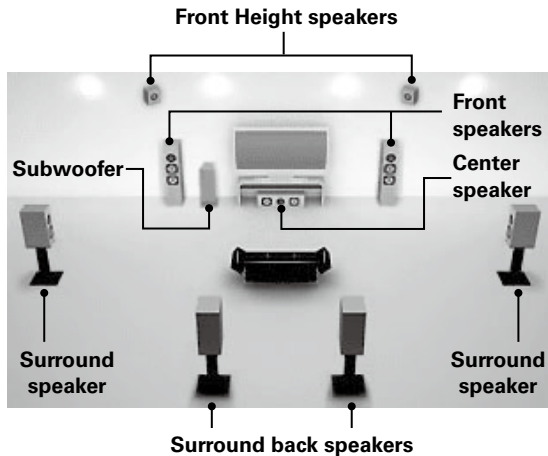

NOTE

- It is not possible to use the front height speakers and surround back speakers simultaneously.
- To play surround back speakers or front height speakers, connect a power amplifier to the AVR-590's SURR. BACK / FRONT HEIGHT PRE OUT connectors (page 11).

When 7.1ch (Surround Back Speaker) Connected

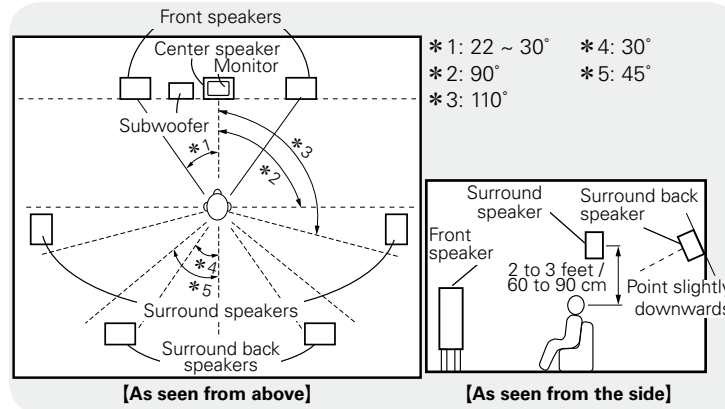

When 5.1ch Connected

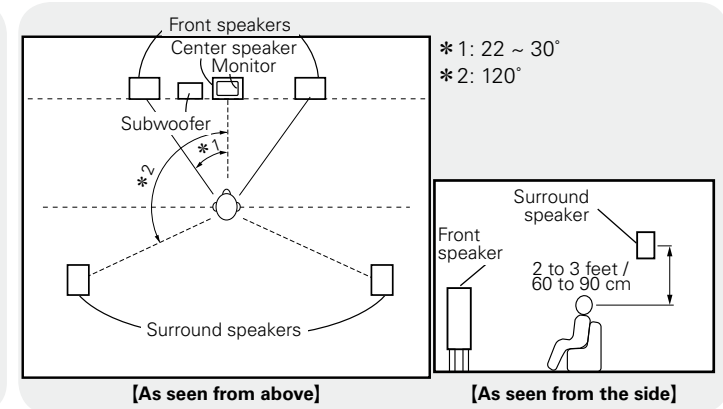

When 6.1ch Connected

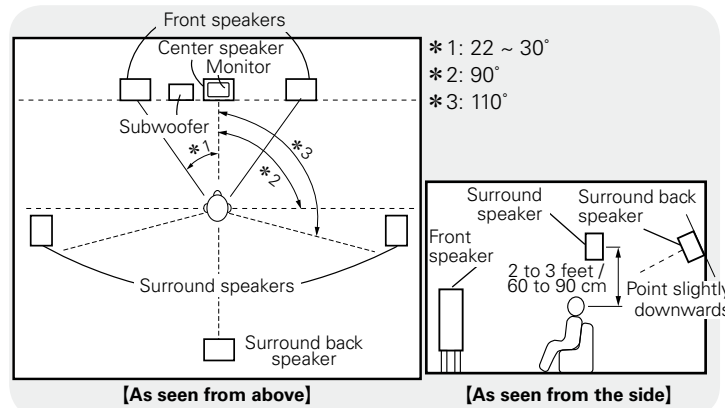



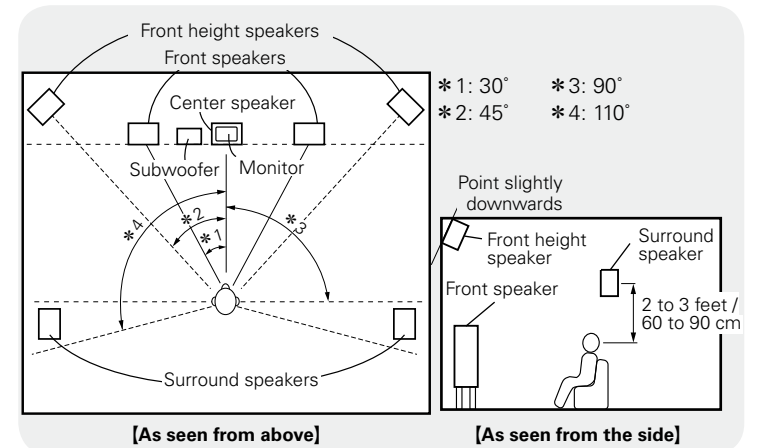

When 7.1ch (Front Height Speaker) Connected



Installing/Setting the Speakers

2 Set the "Pre Assign" Mode According to the Speaker Layout.

The signals output from the AVR-590's SURR. BACK / FRONT HEIGHT PRE OUT connectors can be switched to signals of the surround mode being used (☞ page 24 "Pre Assign").



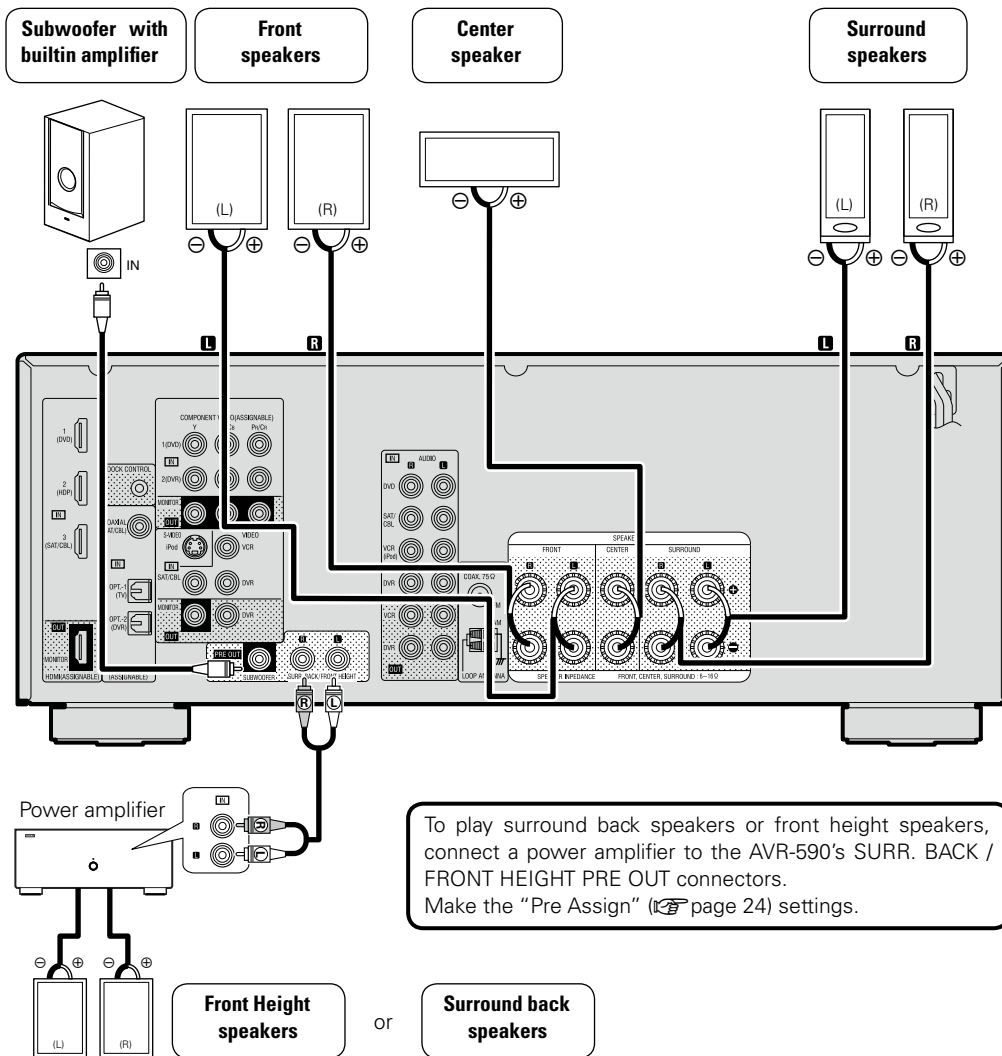

Pre Assign mode (☞ page 24)	The speaker which plays a sound output from the SURR. BACK / FRONT HEIGHT PRE OUT connectors	Example of speaker installation
Normal (Default)	Surround back speakers	 (7.1)
Normal	Surround back speakers ※ Connect to the SURR. BACK / FRONT HEIGHT PRE OUT "L" connector. ※ Set "S.Back (Pre out)" (☞ page 25) to "1ch".	 (6.1)
Normal	Not connected ※ Set the "S.Back (Pre out)" setting (☞ page 25) to "None".	 (5.1)
Front Height	Front Height speakers	 (7.1)

Connecting the Speakers



Connecting the Speaker Cables

Carefully check the left (L) and right (R) channels and + (red) and – (black) polarities on the speakers being connected to the AVR-590, and be sure to interconnect the channels and polarities correctly.

- 1 Peel off about 10 mm of sheathing from the tip of the speaker cable, then either twist the core wire tightly or terminate it. 
- 2 Turn the speaker terminal counterclockwise to loosen it. 
- 3 Insert the speaker cable's core wire to the hilt into the speaker terminal. 
- 4 Turn the speaker terminal clockwise to tighten it. 

When using a banana plug

Tighten the speaker terminal firmly before inserting the banana plug.



Use speakers with an impedance of 6 to 16 Ω /ohms.

NOTE

- Connect the speaker cables in such a way that they do not stick out of the speaker terminals. The protection circuit may be activated if the core wires touch the rear panel or if the + and – sides touch each other (☞ “Protection circuit”).
- Never touch the speaker terminals while the power supply is connected. Doing so could result in electric shock.

Protection circuit

If the core wires touch the rear panel and the screws etc., or the \pm sides touch each other, the protection circuit will be activated and the power indicator will flash red at intervals of 0.5 secs.

If the protection circuit is activated, the speaker output is isolated, and the power supply goes to the standby state. If the power supply is turned off, after the power supply cord is withdrawn, please confirm that speaker cable and input cable are connected.

Also, if replaying large sound levels by using a speaker having an impedance less than that specified (eg, 4 Ω /ohms), the temperature will rise, and the protection circuit might be activated. The power supply will go into the standby state, and the power indicator will flash red at 2 second intervals.

In this case, please switch off the power supply, and wait until the AVR-590 has cooled down, and the surrounding ventilation is good.

Even if there are no problems with the surrounding ventilation and connections, in the event of the protection circuit becoming activated,

due to thinking that the AVR-590 has failed, please contact DENON Service center after switching off.

Connecting Devices

Connecting Devices Equipped with HDMI connectors

Important Information

About HDMI

“HDMI” is the abbreviation of “High Definition Multimedia Interface”. This interface allows transfer of digital video signals and digital audio signals over a single HDMI cable.

“HDMI”, “HDMI logo” and “High-Definition Multimedia Interface” are trademarks or registered trademarks of HDMI Licensing LLC.

Functions usable with HDMI connections

Deep Color

Eliminates on-screen color banding, for smooth tonal transitions and subtle gradations between colors.

x.v.Color

Enables displays with natural, vivid colors. “x.v.Color” is a Sony registered trademark.

Auto Lip Sync (☞ page 27)

HDMI 1.3 incorporates an automatic video/audio synching capability that allows devices to perform this synchronization automatically with total accuracy.

HDMI control function (☞ page 27, 44)

This function allows you to operate external devices from the receiver and operate the receiver from external devices.

NOTE

These functions will not work if the device connected to the HDMI connector does not support Deep Color or x.v.Color signal transfer or the Auto Lip Sync function.

Copyright protection system (HDCP)

The AVR-590 supports HDCP (High-bandwidth Digital Contents Protection). HDCP is a copyright protection technology for digital video signals. The devices connected to the AVR-590 must also support HDCP.

NOTE

When a device that does not support HDCP is connected, video signals are not properly output.

Connections

The AVR-590 allows connection of inputs from up to 3 HDMI devices and output to 1 TV.

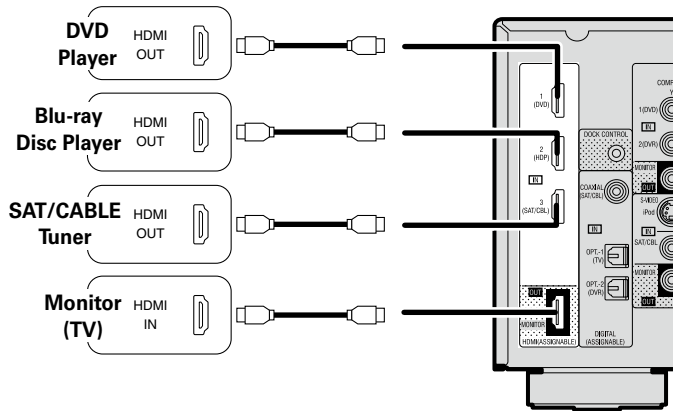

- Use a cable on which the HDMI logo is indicated (a certified HDMI product) for connection to the HDMI connector. Normal playback may not be possible when using a cable other than one on which the HDMI logo is indicated (a non-HDMI-certified product).
- When the AVR-590 is connected to other devices with HDMI cables, also connect the AVR-590 and TV using an HDMI cable.
- When a device supporting Deep Color signal transfer is connected, use a cable compatible with HDMI ver.1.3a.
- Video signals are not output if the input video signals do not match the monitor's resolution. In this case, switch the Blu-ray Disc player / DVD player's resolution to a resolution with which the monitor is compatible.

NOTE

- If the menu "HDMI Audio Out" setting (page 27) is set to "AMP", the sound may be interrupted when the monitor's power is turned off.
- The audio signal from the HDMI output connector (sampling frequency, number of channels, etc.) may be limited by the HDMI audio specifications of the connected device regarding permissible inputs.

Connecting to a device equipped with a DVI-D connector

When an HDMI/DVI conversion cable (sold separately) is used, the HDMI video signals are converted to DVI signals, allowing connection to a device equipped with a DVI-D connector.

NOTE

- No sound is output when connected to a device equipped with a DVI-D connector. Also make the audio connections.
- Signals cannot be output to DVI-D devices that do not support HDCP.
- Depending on the combination of devices, the video signals may not be output.

Settings related to HDMI connections

Set as necessary. For details, see the respective reference pages.

Input connector assignment (page 31)

Set this when changing the input sources of the different connectors.

HDMI Setup (page 27)

Make these settings related to HDMI input/output signals.

- Auto Lip Sync
- HDMI Audio Out
- HDMI Control
- Standby Source
- Power Off Control

NOTE

The audio signals output from the HDMI connectors are only the HDMI input signals.

Connecting Devices not Equipped with HDMI connectors

Monitor (TV)

- Select the terminal to use and connect the device.
- For video connections, see "Converting input video signals for output (Video Conversion Function)" (page 9).

For instructions on HDMI connections, see "Connecting Devices Equipped with HDMI connectors" on page 12.

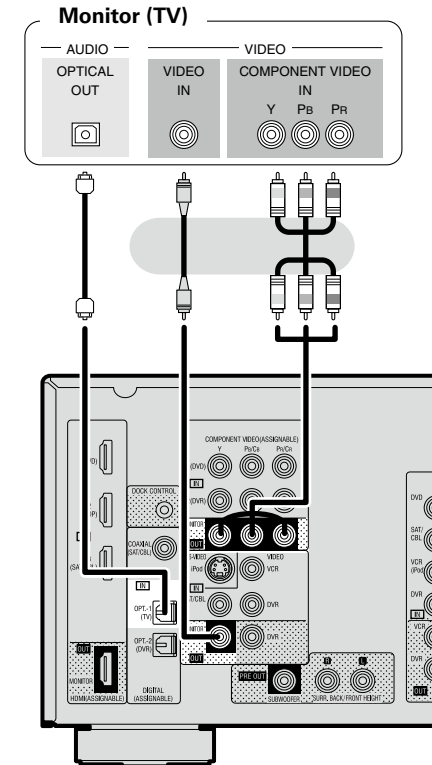

The component video connectors may be indicated differently on your monitor. For details, see the monitor's operating instructions.

Playback Components

Blu-ray Disc player / DVD player

Select the terminal to use and connect the device.

For instructions on HDMI connections, see "Connecting Devices Equipped with HDMI connectors" on page 12.

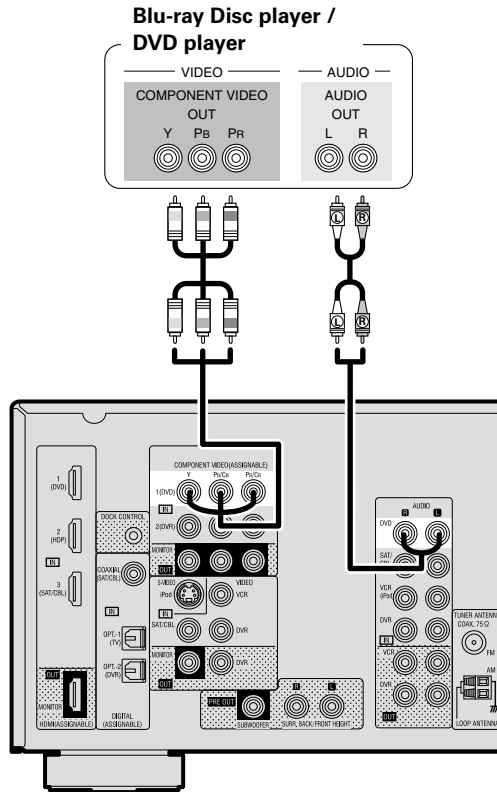

Set as necessary

Set this to change the input signal to which the input source is assigned.

"Assign" (page 31)

NOTE

When connected to a Blu-ray Disc player, and playing Dolby TrueHD, DTS-HD, Dolby Digital Plus, connect the HDMI.

Control dock for iPod®

Use a DENON control dock for iPod (ASD-1R, ASD-11R, ASD-3N or ASD-3W sold separately) to connect the iPod to the AVR-590. For instructions on the control dock for iPod settings, refer to the control dock for iPod's operating instructions.

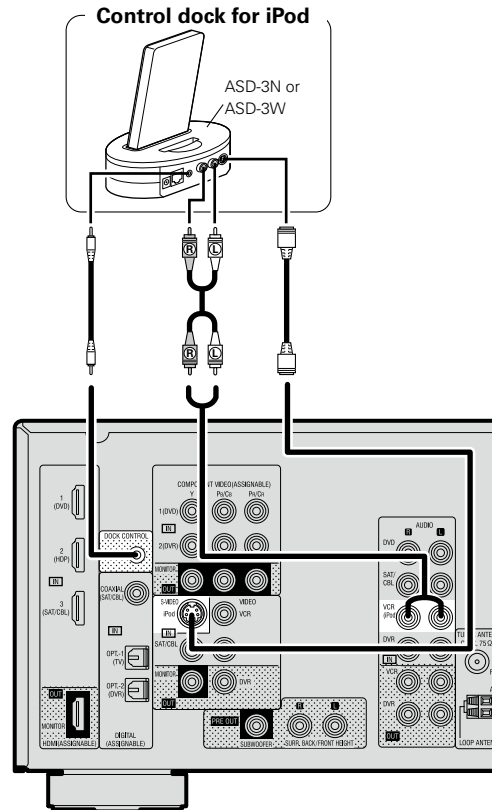

Set as necessary

Set this to assign the iPod to a connector other than "VCR (iPod)" "iPod Dock" (page 31)



With the default settings, the iPod can be used connected to the VCR (iPod) connector.

SAT/CABLE Tuner

Select the terminal to use and connect the device.

For instructions on HDMI connections, see "Connecting Devices Equipped with HDMI connectors" on page 12.

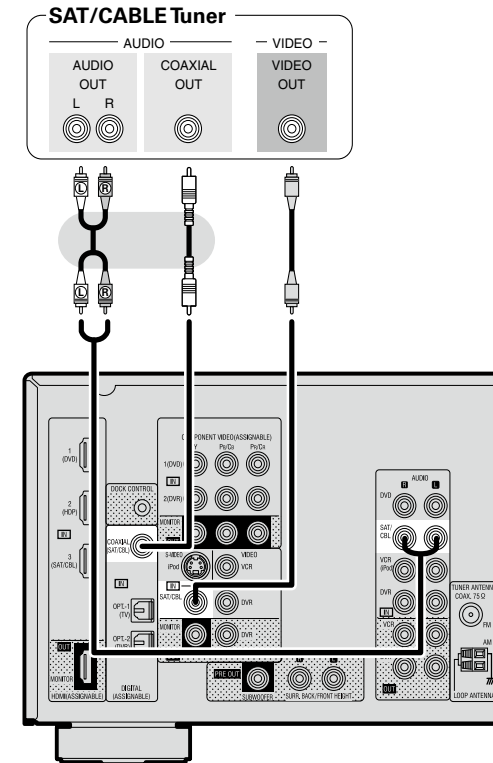

Set as necessary

Set this to change the input signal to which the input source is assigned.

"Assign" (page 31)

Recording Components

Digital Video Recorder

Select the terminal to use and connect the device.

For instructions on HDMI connections, see "Connecting Devices Equipped with HDMI connectors" on page 12.

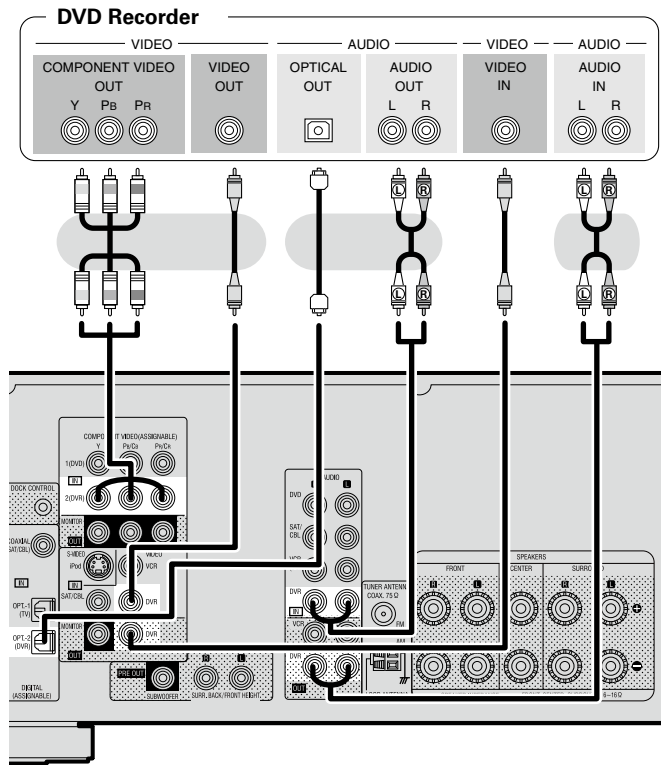

Set as necessary

Set this to change the input signal to which the input source is assigned.

"Assign" (page 31)

NOTE

To record video signals through the AVR-590, use the same type of video cable for connection between the AVR-590 and the player as the cable used for connection between the AVR-590 and the recorder.

Video Cassette Recorder

Select the terminal to use and connect the device.

For instructions on HDMI connections, see "Connecting Devices Equipped with HDMI connectors" on page 12.

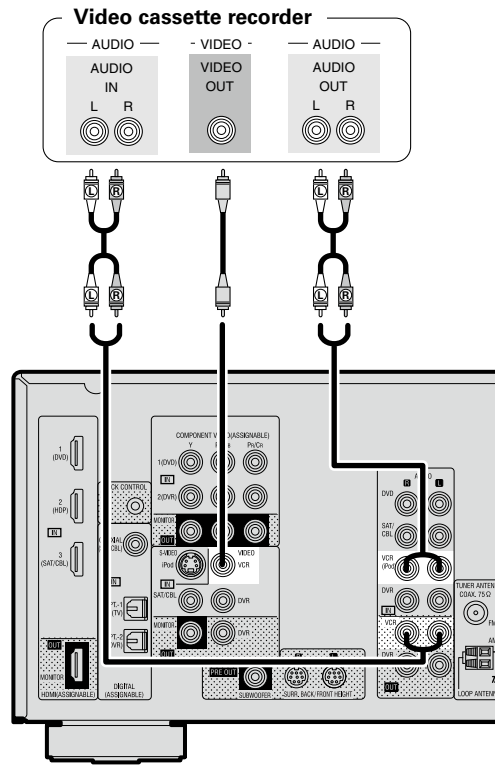

Set as necessary

Set this to change the input signal to which the input source is assigned.

"Assign" (page 31)

NOTE

To record video signals through the AVR-590, use the same type of video cable for connection between the AVR-590 and the player as the cable used for connection between the AVR-590 and the recorder.

Other Devices

Video Camera / Game Console

Video camera / Game console

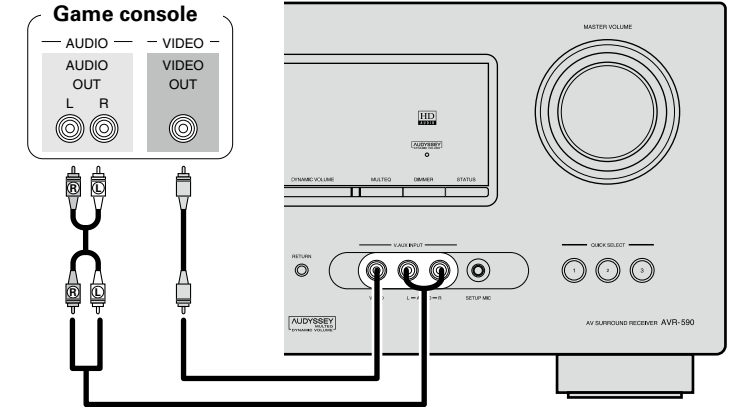

Connecting Devices not Equipped with HDMI connectors

Antenna terminals

Direction of broadcasting station

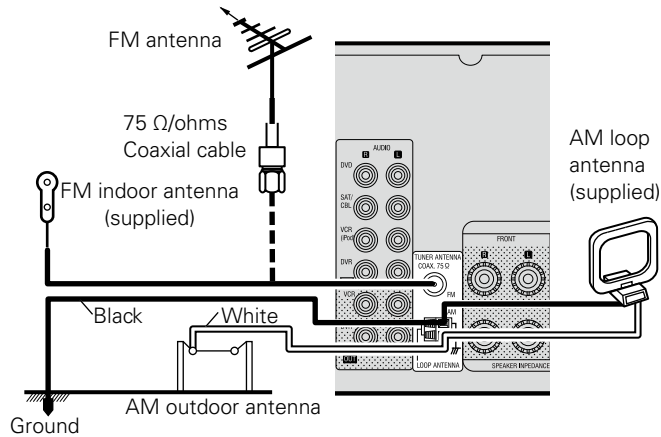

AM loop antenna assembly

- 1 Remove the vinyl tie and take out the connection line.
- 2 Bend in the reverse direction.
- 3-1 With the antenna on top of any stable surface.
- 3-2 With the antenna attached to a wall.

Connection of AM antennas

- 1 Push the lever.
- 2 Insert the conductor.
- 3 Return the lever.

- NOTE**
- Do not connect two FM antennas simultaneously.
 - Even if an external AM antenna is used, do not disconnect the AM loop antenna.
 - Make sure the AM loop antenna lead terminals do not touch metal parts of the panel.

Connecting the Power Cord

Wait until all connections have been completed before connecting the power cord.

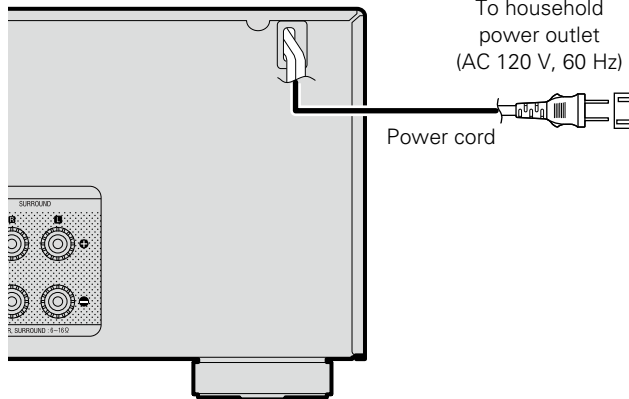

- NOTE**
- Insert the AC plugs securely. Incomplete connections could cause noise.

Once Connections are Completed

Turning the Power On

- 1 Press . The power indicator lights red and the power is set to the standby mode.
 - 2 Press . The power indicator flashes green and the power turns on.
- ※ Also press when in standby mode, the power turns on.
- When has been pressed, the input source set with the is set.
- If a has been pressed, the input source stored in the memory for the quick select function is set (page 45 "Saving frequently used settings (Quick Select Function)").
-

This operation can also be performed by pressing a on the main unit.

Turning the Power Off

- 1 Press . The power is set to the standby mode.
- 2 Press . The power indicator turns off, and so does the power.

- NOTE**
- Power continues to be supplied to some of the circuitry even when the power is in the standby mode. When leaving home for long periods of time or when traveling, either press to turn off the power, or unplug the power cord from the power outlet.

Settings

With the AVR-590, settings and operations for most functions can be performed by operating while looking at the menus displayed on the monitor screen.

Menu map

Operations

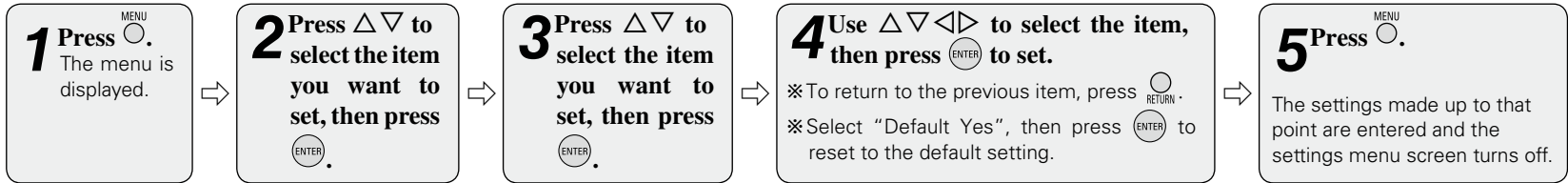

Setting menus

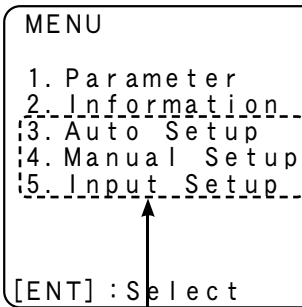

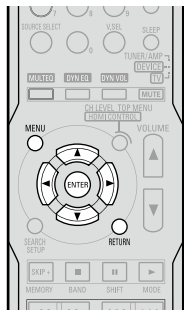

Items that only need to be set once
 Set these for example upon purchase.
 Once these items are set, there is no need to set them again unless the speaker layout or the connected speakers have been changed.



Setting items	Number	Detailed items	Description	Page
1. Parameter Adjust various audio parameters.	1-1	Surround Parameter	Adjust surround sound parameters.	39
	1-2	Tone Control	Adjusts the treble and bass tone.	41
	1-3	Audyssey Settings	Makes the MultEQ, Dynamic EQ and Dynamic Volume settings.	41
	1-4	Manual EQ	Adjust tonal quality for each speaker using graphic equalizer.	42
	1-5	RESTORER	Uncompress compressed sources and apply bass boost for richer sound.	43
	1-6	Audio Delay	Compensate for incorrect timing between video and audio.	43
2. Information Show information about receiver settings, input signals, etc.	2-1	Status	Shows information about current settings.	43
	2-2	Audio Input Signal	Shows information about audio input signals.	43
	2-3	HDMI Information	Displays the HDMI input/output signals and TV information.	43
	2-4	Auto Surround Mode	Displays the settings stored for the auto surround mode.	43
	2-5	Quick Select	Displays the settings stored for the Quick Select function.	43
	2-6	Preset Channel	Shows information about preset channels.	43
3. Auto Setup Makes the optimum speaker settings and corrects for the acoustic characteristics of the room.	3-1	Audyssey Auto Setup	Makes the optimum settings for the speakers being used automatically.	20
	3-2	Parameter Check	Check Audyssey Auto Setup measurement results. This item is only displayed after the Audyssey Auto Setup procedure has been performed.	23
4. Manual Setup Use this to make various types of detailed settings.	4-1	Speaker Setup	Sets the speaker size and distance, the channel level, etc.	24
	4-2	HDMI Setup	Make settings for HDMI video/audio output.	27
	4-3	Audio Setup	Make settings for audio playback.	28
	4-4	Option Setup	Make various other settings.	28
5. Input Setup Use this to make settings related to playing input sources.	5-1	Assign	Change input connector assignment.	31
	5-2	Input Mode	Sets the audio input mode and decode mode.	32
	5-3	Rename	Change the display name for this source.	32
	5-4	Source Level	Adjust the playback level of the audio input.	33
	5-5	iPod Playback Mode	Make settings for iPod playback.	33
	5-1	Auto Preset	Use the auto preset function to program radio stations.	33
	5-2	Preset Skip	Set the preset memories that you do not want to display when tuning.	33
	5-3	Preset Name	Assign name to a preset memory.	33

Examples of On-screen Display and Front Display

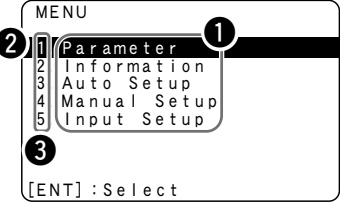
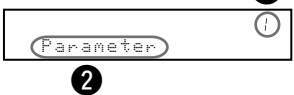
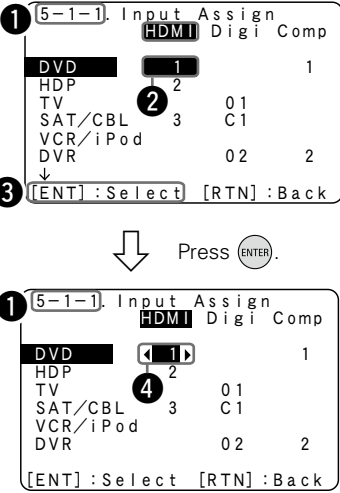
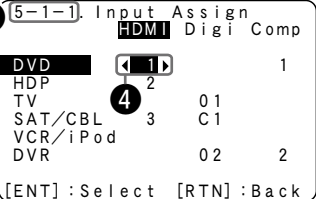
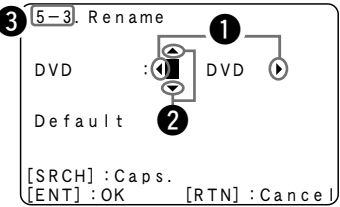
Below we describe typical examples of displays on the TV screen and on the set's display window.

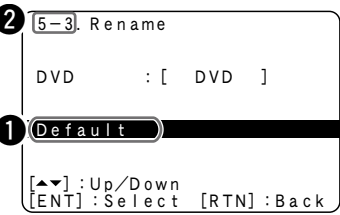
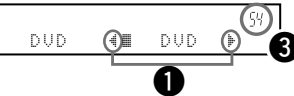
On-screen Display	Front Display	Description
<p>❑ Top menu display</p>  <p>[ENT] : Select</p>		<p>① : The menu items are displayed here. ② : The selected line is displayed here. The currently selected item is displayed on the display. Use Δ/∇ to move to the item you want to set. ③ : The number of the current selected setting menu is displayed.</p>
<p>❑ Display when changing settings</p>  <p>[ENT] : Select [RTN] : Back</p> <p>↓ Press [ENTER].</p> <p>[ENT] : Select [RTN] : Back</p>	 <p>↓ Press [ENTER].</p>	<p>① : The number of the current selected setting menu is displayed. ② : Use Δ/∇/\leftarrow/\rightarrow to move to the item you want to set. ③ : Press [ENTER] to set to the mode in which the setting can be made. ④ : \leftarrow/\rightarrow is displayed at the sides of items whose setting can be changed. Use \leftarrow/\rightarrow to change to the desired setting.</p>
<p>❑ Display when inputting characters</p>  <p>[SRCH] : Caps. [ENT] : OK [RTN] : Cancel</p>		<p>① : When \leftarrow/\rightarrow is pressed, the cursor moves to the left or right. ② : When Δ/∇ is pressed at the position at which you want to input the character, the character is input. ③ : The number of the current selected setting menu is displayed.</p>
<p>❑ Display when resetting</p>  <p>[^v] : Up/Down [ENT] : Select [RTN] : Back</p>		<p>① : Press ∇ to select "Default," then press [ENTER] to set. ② : The number of the current selected setting menu is displayed.</p>



Making the Optimum Settings for the Connected Speakers Automatically (Audyssey Auto Setup)

The acoustic characteristics of the connected speakers and listening room are measured and the optimum settings are made automatically.

Audyssey Auto Setup Flow

Step 1 : Connect the included Setup Microphone (👉 page 20)



Step 2 : Audyssey Auto Setup Preparations (👉 page 21)

Changing the PRE OUT connectors assignment (Pre Assign) (👉 page 21)



Step 3 : Performing the Audyssey Auto Setup Procedure (👉 page 21)

Check Audyssey Auto Setup Measurement Results (Parameter Check) (👉 page 23)

Important Information

Audyssey MultEQ® automatically measures the acoustical problems in the listening environment to create the best audio experience for your home theater.

- When the Audyssey Auto Setup procedure is performed, the MultEQ, Dynamic EQ and Dynamic Volume functions (👉 page 41) are enabled.
- Use the included setup microphone (DM-A409) to perform the Audyssey Auto Setup procedure.
- Measurements are performed by placing the calibrated microphone successively at multiple positions throughout the listening area as shown in **[Example ①]**. For best results, it is strongly recommended to measure 6 positions so that the measurements have the proper spatial weighting.

Even if the listening environment is small as shown in **[Example ②]**, measuring at multiple points throughout the listening environment results in more effective correction.

- FHL** : Front height speaker (L)
- FL** : Front speaker (L)
- SW** : Subwoofer
- C** : Center speaker
- FR** : Front speaker (R)
- FHR** : Front height speaker (R)
- SR** : Surround speaker (R)
- SBR** : Surround back speaker (R)
- SBL** : Surround back speaker (L)
- SL** : Surround speaker (L)

About the main listening position (*M)

The main listening position refers to the most central position where one would normally sit within the listening environment. MultEQ uses the measurements from this position to calculate speaker distance, level, polarity, and the optimum crossover value for the subwoofer.

NOTE

- Loud test sounds may be played during Audyssey MultEQ automatic speaker setup. This is part of normal operation. If there is background noise in room, these test signals will increase in volume.
 - Do not stand between the speakers and setup microphone or allow obstacles in the path while the measurements are being made. This will cause inaccurate readings.
 - Make the room as quiet as possible. Background noise can disrupt the room measurements. Close windows, silence cell phones, televisions, radios, air conditioners, fluorescent lights, home appliances, light dimmers, or other devices as measurements may be affected by these sounds.
- Cell phones should be placed away from all audio electronics during the measurement process as Radio Frequency Interference (RFI) may cause measurement disruptions (even if the cell phone is not in use).

When using Front Height Speakers

[Example ①]

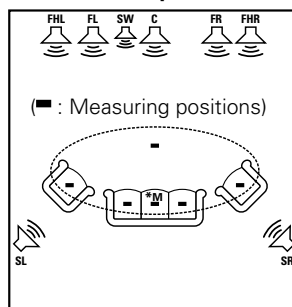

[Example ②]

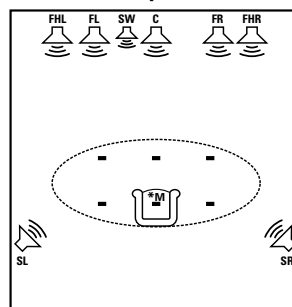

When using Surround Back Speakers

[Example ①]

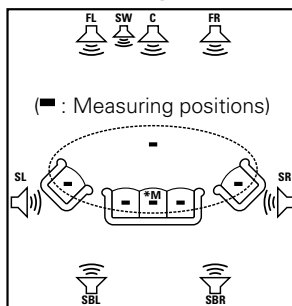

[Example ②]

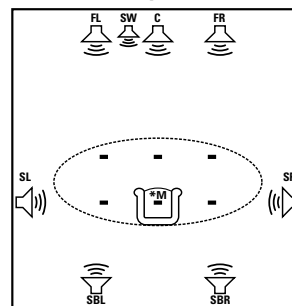

Step 1 : Connect the included Setup Microphone

NOTE

- Do not disconnect the setup microphone until the Audyssey Auto Setup procedure is completed.
- When using headphones, unplug the headphones before starting the Audyssey Auto Setup procedure.

1 Check the speaker connections.

(☞ page 11 "Connecting the Speakers")

2 Turn on the power of the TV and subwoofer.

Set the TV's input to the AVR-590.

3 Turn on the AVR-590's power.

(☞ page 16 "Turning the Power On")

4 Connect the included calibrated setup microphone to the SETUP MIC jack on the main unit.

The Audyssey Auto Setup screen appears automatically.

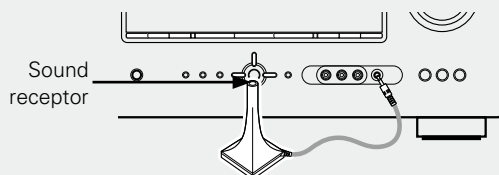

5 Mount the setup microphone on a tripod or stand and install it at the main listening position.

When installing the setup microphone, adjust its height so that the section where the sound is received is at the height of the ears during listening.

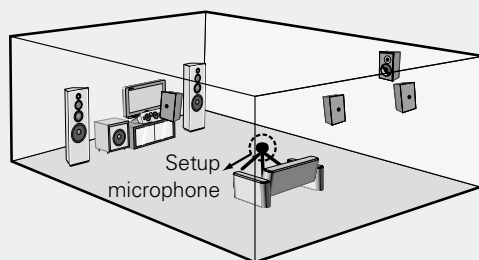

NOTE

- Do not hold the microphone in your hand during measurements.
- Avoid placing the microphone close to a seat back or wall as sound reflections may give inaccurate results.

When using a subwoofer on which the volume can be adjusted and the crossover frequency can be set

When using a subwoofer, make the following settings before starting the Audyssey Auto Setup procedure:

When using a subwoofer with a direct mode

Set the direct mode to "On" and disable the volume adjustment and crossover frequency setting.

When using a subwoofer without a direct mode

Make the following settings:

- Volume : "12 o'clock position"
- Crossover frequency : "Maximum/Highest Frequency"
- Low pass filter : "Off"
- Standby mode : "Off"

Step 2 : Audyssey Auto Setup Preparations

 around items indicate the settings made upon purchase.

If adjustment to the environment is necessary, set the following items before proceeding.

Changing the PRE OUT connectors assignment (Pre Assign)

The signals output from the AVR-590's SURR. BACK / FRONT HEIGHT PRE OUT connectors can be switched to signals of the surround mode being used.

1 Press $\Delta \nabla$ to select "Pre Assign".

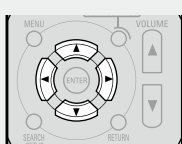

2 Press $\triangleleft \triangleright$ to select Pre Assign Mode.

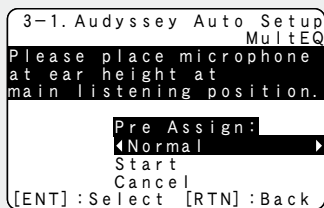

Normal

: The sound of the surround back channel is output from the SURR. BACK / FRONT HEIGHT PRE OUT connectors.

Front Height

: The sound of the front height channel is output from the SURR. BACK / FRONT HEIGHT PRE OUT connectors.

To cancel Audyssey Auto Setup

Use $\Delta \nabla$ to select "Cancel", then use $\triangleleft \triangleright$ to select "Yes".

Step 3 : Performing the Audyssey Auto Setup Procedure

- The Audyssey Auto Setup function detects the presence of each speaker and automatically calculates the speaker size, channel level, distance, and optimal crossover frequency setting. Audyssey MultEQ corrects acoustical distortions within the listening area.
- Once started, MultEQ will play a series of test tones through each speaker.
- Before starting, connect and position all of your speakers.

1 Press $\Delta \nabla$ to select "Start", then press ENTER .

Detection of the speaker configuration starts.

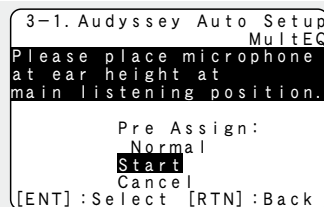

2 Once all the speakers have been detected and the screen on the right appears, check the results of detection of the connected speakers.

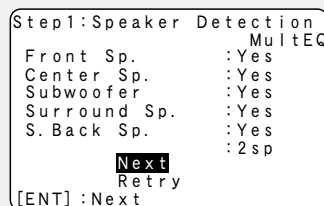

3 Once you have checked the results, use $\Delta \nabla$ to select "Next", then press ENTER .

Measurements for the main listening position begin.

4 Once the screen on the right appears, move the setup microphone to the second position, use $\Delta \nabla$ to select "Next", then press ENTER .

Measurements for the second position begin.

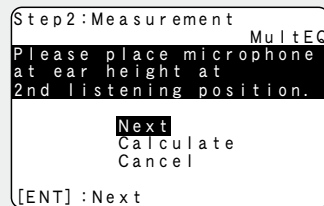

5 Perform Step 4 repeatedly for the 3rd, 4th, 5th, and 6th measurements.

Once measurements for the sixth position are completed, "All the measurements were finished." is displayed.

- ※ Measure at a total of six positions, including the main listening position and positions around it. It is possible to stop the settings with five positions or fewer, but for better results we recommend measuring at six positions.

6 Once measurements are finished, use $\Delta \nabla$ to select "Calculate", then press ENTER .

Analysis begins.

- ※ Analysis takes several minutes to complete. The time required for this analysis depends on the number of speakers connected. The greater the number of speakers connected, the longer analysis will take.

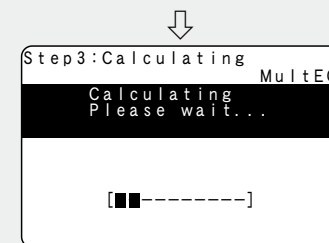
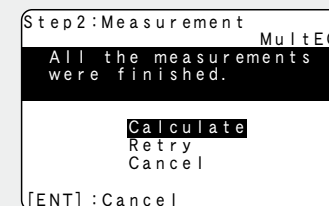

7 Use $\Delta \nabla$ to select the item you want to check, then press ENTER .



The measurement result confirmation screen is displayed.

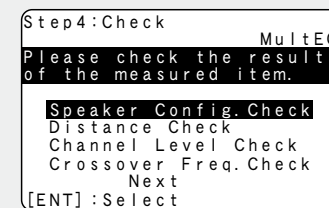

- ※ Subwoofers or other speakers may be set to a value that does not correspond to the actual distance.

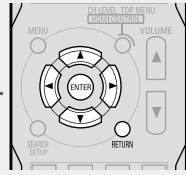

8 Press . This returns you to analysis results items, so repeat step 7.





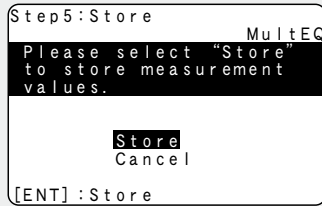

9 Press  to select “Next”, then press .

10 Press   to select “Store”, then press .

“Storing Please wait...” is displayed on the on-screen display while the results are being stored. When storing is complete, “Storing complete. Auto Setup is now finished.” is displayed on the on-screen display.



※ If you do not want to save the measurement results, use   to select “Cancel”, then select “Yes” using  . All the measured Audyssey Auto Setup data will be erased.

NOTE



Do not turn the power off while the settings are being stored.

12 Disconnect the setup microphone from the AVR-590.

NOTE

Do not change the speaker connections or subwoofer volume, or speaker locations after making measurements. If changes are necessary, make the changes and use the Audyssey Auto Setup once again for an updated EQ solution.



- If the result differs from the actual connection status or an error message appears, use   to on-screen display “Retry” and then press  to repeat the measurement.
- If the result still differs from the actual connection status after re-measurement or the error message still appears, it is possible that the speakers are not connected properly. Turn the AVR-590 off, check the speaker connections and repeat the measurement process from the beginning.
- For instance, If the location or direction of a speaker is altered, the Audyssey Auto Setup should be performed again to ensure the correct EQ solution for the new room configuration.

Error Messages

If the Audyssey Auto Setup procedure could not be completed due to speaker installation, the measuring environment, etc., an error message is displayed. If this happens, check the relevant items, be sure to take the necessary measures, then perform the Audyssey Auto Setup procedure over again.

NOTE Be sure to turn the power off before checking the speaker connections.

Error messages (examples)	Cause	Measures
	<ul style="list-style-type: none"> Included setup microphone is not connected. Not all speakers could be detected. The front L speaker was not properly detected. 	<ul style="list-style-type: none"> Connect the included setup microphone to the SETUP MIC jack on the main unit. Check the speaker connections.
	<ul style="list-style-type: none"> Too much noise in the room for accurate measurements to be made. Speaker or subwoofer sound is too low for accurate measurements to be made. 	<ul style="list-style-type: none"> Either turn off any device generating noise or move it away. Try again when the surroundings are quieter. Check the speaker installation and the direction in which the speakers are facing. Adjust the subwoofer's volume.
	<ul style="list-style-type: none"> Displayed speaker could not be detected. The front R speaker were not properly detected. Only one channel of the surround speakers was detected. Sound was output from the R channel when only one surround back speaker was connected. The surround back, but the surround speaker was not detected. 	<ul style="list-style-type: none"> Check the connections of the displayed speaker.
	<ul style="list-style-type: none"> Displayed speaker connected with the polarities reversed. 	<ul style="list-style-type: none"> Check the polarities of the displayed speaker. For some speakers, this error message may be displayed even if the speaker is properly connected. If you are sure that the wiring is correct, press to select "Skip"; then press .

To perform the Audyssey Auto Setup procedure again

Press to select "Retry", then press .

To cancel Audyssey Auto Setup

Use to select "Cancel", then select "Yes" using .

Check Audyssey Auto Setup Measurement Results (Parameter Check)

This is displayed after the Audyssey Auto Setup procedure is completed.

1 Press to select "Parameter Check", then press .

"Parameter Check" is displayed on the on-screen display.

2 Use to select the item you want to check, then press .

- Speaker Config. Check** : Check the speaker configuration
- Distance Check** : Check the distance
- Channel Level Check** : Check the channel level
- Crossover Freq. Check** : Check the crossover frequency
- EQ Check** : Check the equalizer

3 Use to switch the display between the different speakers.

4 Press .

The confirmation screen reappears. Repeat steps 2 and 3.



Even if the settings are changed after the Audyssey Auto Setup procedure, the Audyssey Auto Setup settings can be restored by selecting "Restore" then pressing .



Making detailed settings (Manual Setup)

Use this procedure to change the Audyssey Auto Setup settings or to change the various audio, video and display settings.
The set can be used without changing these settings. Make these settings as necessary.
For a description of "Menu map" and operating instructions, see page 17.

Items that can be set with the Manual Setup procedure



Making the speaker settings (Speaker Setup) page 24



Making the HDMI settings (HDMI Setup) page 27



Making the audio settings (Audio Setup) page 28



Making other settings (Option Setup) page 28

Examples of Menu Screen Displays

Speaker Setup

4-1. Speaker Setup
1. Pre Assign
2. Speaker Config.
3. Bass Setting
4. Distance
5. Channel Level
6. Crossover Freq.
[ENT] : Select [RTN] : Back

Audio Setup

4-3. Audio Setup
1. Auto Surround Mode
2. EQ Customize
[ENT] : Select [RTN] : Back

HDMI Setup

4-2. HDMI Setup
Auto Lipsync : ON
HDMI Audio Out : Amp
HDMI Control : OFF
[RTN] : Back

Option Setup

4-4. Option Setup
1. Volume Control
2. Source Delete
3. On-Screen Display
4. Quick Select Name
5. Setup Lock
[ENT] : Select [RTN] : Back



Making the speaker settings (Speaker Setup)

Default settings are underlined.

Use this procedure to set the speakers manually or if you wish to change the settings made with the Audyssey Auto Setup procedure.

Setting items	Setting contents
Pre Assign Sets the signal output from the SURR. BACK / FRONT HEIGHT PRE OUT connectors.	Normal : The surround back channel audio signals are output. Front Height : The front height channel audio signals are output.
Speaker Config. Select speaker configuration and size. (bass reproduction capability)	Front : Set the front speaker size. <ul style="list-style-type: none"> • Large : Use of a large speaker that can adequately play back low frequencies. • Small : Use of a small speaker that has inadequate playback capacity for low frequencies. <p> If "Subwoofer" is set to "No", "Front" is automatically set to "Large".</p> Center : Set the presence and size of the center speaker. <ul style="list-style-type: none"> • Large : Use of a large speaker that can adequately play back low frequencies. • Small : Use of a small speaker that has inadequate playback capacity for low frequencies. • None : Select when a center speaker is not connected. <p> "Large" is not displayed when "Front" is set to "Small". • Even if "Center" has been set to "Large", when "Front" is set to "Small", the "Center" setting automatically switches to "Small".</p> <ul style="list-style-type: none"> • Subwoofer : Set the presence of a subwoofer. • Yes : Use a subwoofer. • No : Select when a subwoofer is not connected. <p> When "Front" is set to "Small", "Subwoofer" can automatically set to "Yes".</p>

NOTE

Select "Large" or "Small" not according to the physical size of the speaker but according to the low frequency reproduction capabilities based on the frequency set at "Crossover Frequency" (page 26).

See overleaf

Remote control operation buttons



MENU : Displaying the menu
○ : Cancel the menu



: Moves the cursor (Up/Down/Left/Right)



ENTER : Decision the setting



RETURN : Return to previous menu

Setting items	Setting contents
<p>Speaker Config. Select speaker configuration and size. (bass reproduction capability)</p> <p>“S.Back” is displayed when the “Pre Assign” setting (page 24) is set to “Normal”.</p> <p>“Front Height” is displayed when the “Pre Assign” setting (page 24) is set to “Front Height”.</p> <p>NOTE Select “Large” or “Small” not according to the physical size of the speaker but according to the low frequency reproduction capabilities based on the frequency set at “Crossover Frequency” (page 26).</p>	<p>Surround : Set the presence and size of the Surround speakers.</p> <ul style="list-style-type: none"> • Large : Use of a large speaker that can adequately play back low frequencies. • Small : Use of a small speaker that has inadequate playback capacity for low frequencies. • None : Select when the surround speakers are not connected. <p>✎ “Large” is not displayed when “Front” is set to “Small”.</p> <p>S.Back (Pre out) : Set the presence, size and number of surround back speakers.</p> <ul style="list-style-type: none"> • Large : Use of a large speaker that can adequately play back low frequencies. • Small : Use of a small speaker that has inadequate playback capacity for low frequencies. • None : Select when the surround back speakers are not connected. • 2ch : Use two surround back speakers. • 1ch : Use only one surround back speaker. Surround back audio is output from the SURR. BACK / FRONT HEIGHT PRE OUT “L” connector. <p>✎ • “Large” is not displayed when “Surround” is set to “Small”. • Even if “S.Back” is set to “Large”, the “S.Back” setting is automatically switched to “Small” if “Surround” is set to “Small”.</p> <p>NOTE Even when the Surround Back Speaker setting is other than “None”, sound may not be emitted from the surround back speaker, depending on the playback source. In this case, “Surround Back” setting other than “OFF” (page 40).</p> <p>Front Height (Pre out) : Set the front height speaker size.</p> <ul style="list-style-type: none"> • Large : Use of a large speaker that can adequately play back low frequencies. • Small : Use of a small speaker that has inadequate playback capacity for low frequencies. • None : Select when a front height speaker is not connected. <p>✎ • “Large” is not displayed when “Front” is set to “Small”. • Even if “Front Height” is set to “Large”, the “Front Height” setting is automatically switched to “Small” if “Front” is set to “Small”.</p>

Setting items	Setting contents
<p>Bass Setting Make the settings related to playback of low frequency signals (subwoofer and LFE).</p> <p>This can be set when “Speaker Config.” – “Subwoofer” (page 24) is set to “Yes”.</p>	<p>Subwoofer Mode : Select low range signal to be reproduced by subwoofer.</p> <ul style="list-style-type: none"> • LFE : Add the low frequency signal of the channel for which the speaker size is set to “Small” to the subwoofer signal and output it. • LFE+Main : Add the low frequency signal of all channels to the subwoofer signal and output it. <p>✎ • Play music or a movie source and select the mode offering the strongest bass. • Select “LFE+Main” if you want the bass signals to always be produced from the subwoofer.</p> <p>LPF for LFE : Set the upper limit of the low frequency signals output from the subwoofer.</p> <ul style="list-style-type: none"> • 80Hz / 90Hz / 100Hz / 110Hz / 120Hz / 150Hz / 200Hz / 250Hz <p>Unit : Set the unit of distance.</p> <ul style="list-style-type: none"> • Feet • Meters <p>Step : Set the minimum variable width of the distance.</p> <ul style="list-style-type: none"> • 1ft / 0.1ft • 0.1m / 0.01m <p>• FL (Front L)/ FR (Front R)/ C (Center)/ SW (Subwoofer)/ SL (Surround L)/ SR (Surround R)/ SBL (Surr. Back L)/ SBR (Surr. Back R)/ FHL (Front Height L)/ FHR (Front Height R) : Select the speaker you want to set, and set the distance. Set the value that is closest to the measured distance.</p> <ul style="list-style-type: none"> • 0.0ft ~ 60.0ft / 0.00m ~ 18.00m <p>✎</p> <ul style="list-style-type: none"> • The speakers that can be selected differ depending on the “Pre Assign” (page 24) and “Speaker Config.” settings. • Default settings : Front/Center/Subwoofer/Front Height : 3.6 meters (12 feet) Surround/Surr. Back : 3.0 meters (10 feet) <p>NOTE Set the difference in the distance between the speakers to less than 6.0 meters (20 feet). “Relocate Speaker” is displayed on the screen if an inappropriate distance is set.</p> <p>Default : Reset all distance settings to factory default.</p> <ul style="list-style-type: none"> • Yes : Reset to the defaults. • No : Do not reset to the defaults.
<p>Distance Set the distance from the listening position to the speakers. Measure the distance from the listening position to the speakers beforehand.</p>	

Setting items	Setting contents
<p>Channel Level</p> <p>Set the volume of the test tone to be the same when it is output from each speaker.</p>	<p>Test Tone Start : Output test tones.</p> <p>FL (Front L)/ C (Center)/ FR (Front R)/ SR (Surround R)/ SBR* (Surround Back R)/ SBL* (Surround Back L)/ SL (Surround L)/ FHL (Front Height L)/ FHR (Front Height R)/ SW (Subwoofer) : Select the speaker.</p> <p>*When the "S.Back" setting (page 25) is set to "1ch," "SB" is displayed.</p> <ul style="list-style-type: none"> • -12.0dB ~ +12.0dB (0.0dB) : Adjust the volume. <p></p> <ul style="list-style-type: none"> • When "Channel Level" is adjusted, the adjusted values are set for all the surround modes. To adjust the channel level separately for the different surround modes, use the operation see "Adjust the volume of the different speakers" (page 45). • Speakers set to "None" in the "Speaker Config." (page 25) settings are not displayed. • When < is pressed while the subwoofer volume is set to "-12dB," the "Channel Level" setting switches to "OFF." • If output of the test tones begins while the muting mode is set, the muting mode is canceled. <hr/> <p>Default : Reset all channel level settings to factory default.</p> <p>Yes : Reset to the defaults.</p> <p>No : Do not reset to the defaults.</p>
<p>Crossover Frequency</p> <p>Outputs at below set frequency, each speaker's bass signal output from the subwoofer. Set this according to the low frequency reproduction capabilities of the speakers you are using.</p> <p>This can be set when "Speaker Config." - "Subwoofer" (page 25) is set to "Yes" or "No."</p>	<p>Crossover : Outputs at below set frequency, each speaker's bass signal output from the subwoofer.</p> <ul style="list-style-type: none"> • 40Hz / 60Hz / 80Hz / 90Hz / 100Hz / 110Hz / 120Hz / 150Hz / 200Hz / 250Hz • Advanced : Set the low frequency signals to be output from the signals of the respective speakers to the subwoofer. • Front / Center / Surround / S.Back / Front Height : Select the speaker. <ul style="list-style-type: none"> · 40Hz / 60Hz / 80Hz / 90Hz / 100Hz / 110Hz / 120Hz / 150Hz / 200Hz / 250Hz : Set the crossover frequency.

Setting items	Setting contents
<p>Crossover Frequency</p>	<p></p> <ul style="list-style-type: none"> • Always set the crossover frequency to "80 Hz." When using small speakers, however, we recommend setting the crossover frequency to a higher frequency. • For speakers set to "Small," sound below the crossover frequency is cut from the sound output. The cut bass sound is output from the subwoofer or front speakers. • The speakers that can be set when "Advanced" is selected differ according to the "Bass Setting" setting (page 25). <ul style="list-style-type: none"> · When "LFE" is selected, speakers set to "Small" at "Speaker Config." (page 25) can be set. · When "LFE+Main" is selected, speakers can be set regardless of the speaker size setting.



Making the HDMI settings (HDMI Setup)

Default settings are underlined.

Make settings for HDMI video/audio output.

Setting items	Setting contents
Auto Lip Sync Automatic compensation for timing shift in audio and video output.	ON : Compensated. OFF : Not compensated.
HDMI Audio Out Select HDMI audio output device.	Amp : Use speakers connected to AVR-590 for audio playback. TV : Use speakers of TV for audio playback. NOTE When the HDMI control function is operating, the setting of audio playback in the connected TV takes priority (page 44 "Controlling HDMI-compatible devices from the AVR-590 (HDMI Control Function)").
HDMI Control External devices can be controlled from the AVR-590 and the AVR-590 can be controlled from external devices. NOTE The HDMI control function controls operations of a TV that is compatible with the HDMI control function. Make sure that the TV and HDMI are connected when you perform HDMI control.	ON : Use the HDMI control function. OFF : Do not use the HDMI control function. • Please consult the operating instructions for each connected device to check the settings. • For details on the HDMI control function, see "Controlling HDMI-compatible devices from the AVR-590 (HDMI Control Function)" (page 44). NOTE • When "Control" is set to "ON", it consumes more standby power. • When not using this unit for a long period, we recommend that you press to turn off (OFF) the power. • When the "HDMI Control" setting has been changed, always turn off the power to the connecting devices afterwards and then turn back on. • The "HDMI Control" does not work when the power to the equipment is off.
Standby Source Set the HDMI connector for HDMI signal input during standby. This can be set when "HDMI Control" is set to "ON".	Last : Standby with last used input source during power on. HDMI1 / HDMI2 / HDMI3 : The standby mode is set at the input source assigned to the respective.

Setting items	Setting contents
Power Off Control The power of the AVR-590 and external device turn off together. This can be set when "HDMI Control" is set to "ON".	ON : Switched. OFF : Not switched. • Please consult the operating instructions for each connected device to check the settings. • For details on the HDMI control function, see "Controlling HDMI-compatible devices from the AVR-590 (HDMI Control Function)" (page 44).





Making the audio settings (Audio Setup)

Default settings are underlined.

Make settings for audio playback.

Setting items	Setting contents
Auto Surround Mode Make setting for memorizing surround mode setting for each input signal type.	<p>ON : Memorize settings. Most recently stored surround mode is automatically selected.</p> <p>OFF : Do not memorize settings. Surround mode does not change according to input signal.</p> <p> The auto surround mode function lets you store in the memory the surround mode last used for playing the four types of input signals listed below.</p> <ol style="list-style-type: none"> ① Analog and PCM 2-channel signals ② Dolby Digital and DTS 2-channel signals ③ Dolby Digital and DTS multi-channel signals ④ Multi-channel signals other than Dolby Digital and DTS (PCM, etc.)
EQ Customize Set so that unused equalizer settings are not displayed when is used.	<p>Audyssey Byp. L/R / Audyssey Flat / Manual</p> <ul style="list-style-type: none"> • Used • Not Used <p>NOTE</p> <ul style="list-style-type: none"> • Set so that the "Audyssey Byp. L/R" and "Audyssey Flat" settings can be made when the Audyssey Auto Setup procedure is performed. • Equalizer settings for which "Not Used" is set with the Quick Select function cannot be stored and called out.











Making other settings (Option Setup)

Default settings are underlined.

Setting items	Setting contents
Volume Control Set the MAIN_ZONE volume setting.	<p>Volume Display : Set the volume display method.</p> <ul style="list-style-type: none"> • Relative : The volume is displayed within the range of --dB (Minimum), -80 dB ~ +18 dB. • Absolute : The volume is displayed within the range of 0, 1 ~ 99. <p>Vol.Limit : Make a setting for maximum volume.</p> <ul style="list-style-type: none"> • OFF : Do not set a maximum volume. • -20dB(61) / -10dB(71) / 0dB(81) <p>Power On Level : This sets the volume set when the MAIN_ZONE's power is turned on.</p> <ul style="list-style-type: none"> • Last : Use the memorized setting from the last session. • --- : Always use the muting on condition when power is turned on. • -80dB(1) ~ +18dB(99) : The volume is adjusted to the set level. <p>Mute Level : This sets the amount of attenuation of the volume when the mute mode is set in the MAIN_ZONE.</p> <ul style="list-style-type: none"> • Full : The sound is cut off entirely. • -40dB : The sound is attenuated by 40 dB. • -20dB : The sound is attenuated by 20 dB.
Source Delete Remove input sources that are not used from the display.	<p>TUNER / DVD / HDP / TV / SAT/CBL / VCR / DVR / V.AUX : Select the sources you do not want to use.</p> <ul style="list-style-type: none"> • ON : Use this source. • Delete : Do not use this source. <p>NOTE</p> <ul style="list-style-type: none"> • The currently selected input source cannot be set. • Input sources set to "Delete" cannot be selected using .
On-Screen Display Make the settings related to displays on the TV screen.	<p>Screensaver : Make screensaver settings.</p> <ul style="list-style-type: none"> • ON : The screen switches to the screensaver if no operation is performed for approximately 3 minutes while a menu is displayed or while an iPod screen is displayed. When you press $\Delta \nabla \triangleleft \triangleright$, the screen saver is cancelled and the screen before that screen saver started is displayed. • OFF : Turn the screensaver function off. <p>Text : The mode name is displayed when the operation for switching the surround mode, input mode, etc., is performed.</p> <ul style="list-style-type: none"> • ON : Turn display on. • OFF : Turn display off. <p>Master Volume : Master volume display during adjustment.</p> <ul style="list-style-type: none"> • Bottom : Displayed at the bottom of the screen. • Top : Displayed at the top of the screen. • OFF : Turn display off.

See overleaf

Setting items	Setting contents
On-Screen Display Make the settings related to displays on the TV screen.	<p>Tuner Information : This sets the time the on-screen display is displayed when a tuner operation is performed.</p> <ul style="list-style-type: none"> • Always : Show display continuously. • 30sec : Show display for 30 seconds after operation. • 10sec : Show display for 10 seconds after operation. • OFF : Turn display off. <p>iPod Information : This sets the time the on-screen display is displayed when an iPod operation is performed.</p> <ul style="list-style-type: none"> • Always : Show display continuously. • 30sec : Show display for 30 seconds after operation. • 10sec : Show display for 10 seconds after operation. • OFF : Turn display off.
Quick Select Name Change the Quick Select name.	<p>Rename Label : Change the display name of the selected "Quick Select" setting.</p> <ol style="list-style-type: none"> 1. Use $\Delta \nabla$ to select the name of the Quick Select setting you want to change, then press . 2. Use $\triangleleft \triangleright$ to set the cursor to the character you want to change. 3. Use $\Delta \nabla$ to change the character, then press . <ul style="list-style-type: none"> • Up to 16 characters can be input. • The input character type can be switched by pressing  while the display name is being changed. • The types of characters that can be input are as shown below. <div style="border: 1px solid black; padding: 5px; margin: 10px 0;"> <p>[Capital letters] ABCDEFGHIJKLMNOPQRSTUVWXYZ</p> <p>[Small letters] abcdefghijklmnopqrstuvwxyz</p> <p>[Symbols] ' () * + - . / : ; < = > ? []</p> <p>[Numbers] 0123456789 (space)</p> </div> 4. Repeat steps 2 and 3 to change the display name. <p>Template : The display name can be changed by selecting "Operation" and "Device Name" from the previously set templates.</p> <ol style="list-style-type: none"> 1. Use $\Delta \nabla$ to select the name of the Quick Select setting you want to change, then press . 2. Use $\Delta \nabla$ to select "Template", then press . 3. Use $\Delta \nabla$ to select "Operation", then press . 4. Use $\Delta \nabla \triangleleft \triangleright$ to select "Device Name", then press . <ul style="list-style-type: none"> • Watch / Listen to / Play / For • DVD / Blu-Ray / HDP / TV / CableTV / Satellite / VCR / DVR / iPod / V.AUX / LD / Movie (When "Operation" is selected to "Watch") • CD / TUNER / iPod / MD / TAPE / MUSIC (When "Operation" is selected to "Listen to") • PC / Game (When "Operation" is selected to "Play") • Father / Mother / Son / Daughter / Brother / Sister / Grandfather / Grandmother / Me (When "Operation" is selected to "For")

Setting items	Setting contents
Quick Select Name	<p>Default : The changed display names are reset to the defaults.</p> <ul style="list-style-type: none"> • Yes : Reset to the defaults. • No : Do not reset to the defaults.
Setup Lock Protect settings from inadvertent change.	<ul style="list-style-type: none"> • ON : Turn protection on. • OFF : Turn protection off. <p> When "Setup Lock" is set to "ON," the settings listed below can no longer be changed. Also, "SETUP LOCKED!" is displayed if you attempt to operate related settings.</p> <ul style="list-style-type: none"> • RESTORER • MultEQ • Dynamic EQ • Dynamic Volume • Channel Level • Audio Delay



Making the input settings (Input Setup)

Make the settings related to the currently selected input source.

Before displaying the menu screen, press  to switch to the input source to be set. The items that can be set differ according to the selected input source.

The set can be used without changing these settings. Make these settings as necessary. For a description of "Menu map" and operating instructions, see page 17.

Items that can be set with the Input Setup procedure

Changing the Input Sources Assigned to the Input Connectors (Assign)

 page 31

Changing the Input Source's Input Mode and Decoding mode (Input mode)

 page 32

Changing the Input Source's Display Name (Rename)

 page 32

Correcting the Input Source's Playback Level (Source Level)

 page 33

Setting the iPod Playback Mode (iPod Playback Mode)

 page 33

Presetting Radio Stations (Auto Preset)

 page 33

Setting the Preset Channels to be Skipped (Preset Skip)

 page 33

Assign Name to a Preset Memory (Preset Name)

 page 33

Examples of Menu Screen Displays

Assign

5-1-1. Input Assign
HDMI Digi Comp
 DVD 1 1
 HDP 2
 TV 01
 SAT/CBL 3 C1
 VCR/iPod
 DVR 02 2
 ↓
 [ENT] : Select [RTN] : Back

Input Mode

5-2. Input Mode
Input Mode : Auto
 Decode Mode : Auto
 [RTN] : Back

Rename

5-3. Rename
DVD : DVD
 Default
 [↔] : Up/Down [↵] : Rename
 [RTN] : Back

Source Level

5-4. Source Level
Source Level : 0dB
 [RTN] : Back

iPod Playback Mode

5-5. iPod Playback Mode
Repeat Mode : One
 Shuffle Mode : OFF
 [RTN] : Back

Auto Preset

5-1. Auto Preset
 Auto Tuning
 Preset Station Memory
 Storing Preset Memory
Start
 [ENT] : Start [RTN] : Back



Preset Skip

5-2. Preset Skip
Block : A
 A Block Presets : ON
 A1 FM 87.50MHz : ON
 A2 FM 89.10MHz : ON
 A3 FM 98.10MHz : ON
 A4 FM107.90MHz : ON
 A5 FM 90.10MHz : ON
 A6 FM 90.10MHz : ON
 A7 FM 90.10MHz : ON
 A8 FM 90.10MHz : ON
 [ENT] : Select [RTN] : Back

Preset Name

5-3. Preset Name
Block : A
 A1FM 87.50MHz :
 A2FM 89.10MHz :
 A3FM 98.10MHz :
 A4FM107.90MHz :
 A5FM 90.10MHz :
 A6FM 90.10MHz :
 A7FM 90.10MHz :
 A8FM 90.10MHz :
 [ENT] : Select [RTN] : Back

Remote control operation buttons

 : Displaying the menu
 : Cancel the menu

 : Moves the cursor (Up/Down/Left/Right)

 : Decision the setting

 : Return to previous menu

Changing the Input Sources Assigned to the Input Connectors (Assign)

Default settings are underlined.

Setting items	Setting contents																		
Input Assign (HDMI) Assign input sources to input connectors.	<p>HDMI : The DVD HDP TV SAT/CBL VCR DVR V.AUX input sources are assigned to the HDMI input connectors as shown below.</p> <ul style="list-style-type: none"> • HDMI1 / HDMI2 / HDMI3 • None : Do not assign an HDMI input connector to the currently selected input source. <p>※ Upon purchase, the settings of the different input sources are as shown below.</p> <table border="1"> <thead> <tr> <th>Input source</th> <th>DVD</th> <th>HDP</th> <th>TV</th> <th>SAT/CBL</th> <th>VCR</th> <th>DVR</th> <th>V.AUX</th> </tr> </thead> <tbody> <tr> <td>Default setting</td> <td>HDMI1</td> <td>HDMI2</td> <td>None</td> <td>HDMI3</td> <td>None</td> <td>None</td> <td>None</td> </tr> </tbody> </table> <p></p> <ul style="list-style-type: none"> • When HDMI is assigned to an input source, the audio signal switches to HDMI along with the video signal. To use with the digital audio input connectors assigned, set menu "Input Mode" (page 32) to "Digital". • When the AVR-590 and TV are connected with an HDMI cable, if the TV is not compatible with HDMI audio signal playback, only the video signals are output to the monitor. • The audio signals input from the analog, digital and EXT. IN connectors are not output to the TV. <p>NOTE When "HDMI Control" is set to "ON", HDMI cannot be assigned to "TV" at the "HDMI" settings (page 27).</p>	Input source	DVD	HDP	TV	SAT/CBL	VCR	DVR	V.AUX	Default setting	HDMI1	HDMI2	None	HDMI3	None	None	None		
Input source	DVD	HDP	TV	SAT/CBL	VCR	DVR	V.AUX												
Default setting	HDMI1	HDMI2	None	HDMI3	None	None	None												
Input Assign (Digital) Assign input sources to input connectors.	<p>Digital : The DVD HDP TV SAT/CBL VCR DVR V.AUX input sources are assigned to the digital audio input connectors as shown below.</p> <ul style="list-style-type: none"> • C1 (COAXIAL) / O1 (OPT1) / O2 (OPT2) • None : Do not assign a digital input connector to the currently selected input source. <p>※ Upon purchase, the settings of the different input sources are as shown below.</p> <table border="1"> <thead> <tr> <th>Input source</th> <th>DVD</th> <th>HDP</th> <th>TV</th> <th>SAT/CBL</th> <th>VCR</th> </tr> </thead> <tbody> <tr> <td>Default setting</td> <td>None</td> <td>None</td> <td><u>OPT1</u></td> <td><u>COAXIAL</u></td> <td>None</td> </tr> </tbody> </table> <table border="1"> <thead> <tr> <th>Input source</th> <th>DVR</th> <th>V.AUX</th> </tr> </thead> <tbody> <tr> <td>Default setting</td> <td><u>OPT2</u></td> <td>None</td> </tr> </tbody> </table>	Input source	DVD	HDP	TV	SAT/CBL	VCR	Default setting	None	None	<u>OPT1</u>	<u>COAXIAL</u>	None	Input source	DVR	V.AUX	Default setting	<u>OPT2</u>	None
Input source	DVD	HDP	TV	SAT/CBL	VCR														
Default setting	None	None	<u>OPT1</u>	<u>COAXIAL</u>	None														
Input source	DVR	V.AUX																	
Default setting	<u>OPT2</u>	None																	

Setting items	Setting contents																
Input Assign (Component) Assign input sources to input connectors.	<p>Component : The DVD HDP TV SAT/CBL VCR DVR V.AUX input sources are assigned to the component video input connectors as shown below.</p> <ul style="list-style-type: none"> • COMP1 (Component video 1 input connector) / COMP2 (Component video 2 input connector) • None : Do not assign the component video input connectors to the currently selected input source. <p>※ Upon purchase, the settings of the different input sources are as shown below.</p> <table border="1"> <thead> <tr> <th>Input source</th> <th>DVD</th> <th>HDP</th> <th>TV</th> <th>SAT/CBL</th> <th>VCR</th> <th>DVR</th> <th>V.AUX</th> </tr> </thead> <tbody> <tr> <td>Default setting</td> <td>COMP1</td> <td>None</td> <td>None</td> <td>None</td> <td>None</td> <td>COMP2</td> <td>None</td> </tr> </tbody> </table>	Input source	DVD	HDP	TV	SAT/CBL	VCR	DVR	V.AUX	Default setting	COMP1	None	None	None	None	COMP2	None
Input source	DVD	HDP	TV	SAT/CBL	VCR	DVR	V.AUX										
Default setting	COMP1	None	None	None	None	COMP2	None										
iPod Dock Change the input source to which the control dock for iPod is assigned.	<p>The control dock for iPod can be assigned to the DVD SAT/CBL VCR DVR V.AUX input sources.</p> <ul style="list-style-type: none"> • Assign : Assign the currently selected input source to the Control Dock for iPod input. • None : Do not assign the currently selected input source to the Control Dock for iPod input. <p></p> <ul style="list-style-type: none"> • With the default settings, the control dock for iPod can be used connected to the VCR (iPod) connector. • Even if "iPod Dock" is set to "Assign", if AVR-590 and control dock for iPod are not connected, the input is used as the normal input source. 																

Changing the Input Source's Input Mode and Decoding mode (Input Mode)

Default settings are underlined.

The selectable input modes depend on the input source and "Assign" setting (page 31 "Changing the input sources assigned to the input connectors").

Setting items	Setting contents																				
Input Mode Set the audio input modes for the different input sources.	<p>Auto : Automatically detect input signal and perform playback. HDMI : Play only signals from HDMI input. Digital : Play only signals from digital input. Analog : Play only signals from analog input.</p> <p>※ Upon purchase, the settings of the different input sources are as shown below.</p> <table border="1"> <thead> <tr> <th>Input source</th> <td>DVD</td> <td>HDP</td> <td>TV</td> <td>SAT/CBL</td> <td>VCR</td> </tr> </thead> <tbody> <tr> <th>Default setting</th> <td>Auto</td> <td>HDMI</td> <td>Digital</td> <td>Auto</td> <td>Analog</td> </tr> </tbody> </table> <table border="1"> <thead> <tr> <th>Input source</th> <td>DVR</td> <td>V.AUX</td> <td>TUNER</td> </tr> </thead> <tbody> <tr> <th>Default setting</th> <td>Auto</td> <td>Analog</td> <td>Analog</td> </tr> </tbody> </table> <p>• The "HDMI" settings are made for input sources for which HDMI input connectors are assigned at "Assign" (page 31). • The "Digital" settings are made for input sources for which digital input connectors are assigned at "Assign" (page 31). • When a digital signal is properly input, the "DIG" indicator lights on the display. If the "DIG" indicator does not light, check the digital input connector assignment and the connections.</p> <p>• This can also be set by pressing or . Each time you press the button, the input mode display will change.</p> <p>Auto → HDMI → Digital → Analog</p>	Input source	DVD	HDP	TV	SAT/CBL	VCR	Default setting	Auto	HDMI	Digital	Auto	Analog	Input source	DVR	V.AUX	TUNER	Default setting	Auto	Analog	Analog
Input source	DVD	HDP	TV	SAT/CBL	VCR																
Default setting	Auto	HDMI	Digital	Auto	Analog																
Input source	DVR	V.AUX	TUNER																		
Default setting	Auto	Analog	Analog																		

Setting items	Setting contents
Decode Mode Set the input source's decoding mode.	<p>Auto : Detect type of digital input signal and decode and play automatically. PCM : Decode and play only PCM input signals. DTS : Decode and play only DTS input signals.</p> <p>• This can be set for input sources for which "HDMI" or "Digital" is assigned at "Assign" (page 31). • Normally set this to "Auto".</p>

Changing the Input Source's Display Name (Rename)

Default settings are underlined>.

Use this procedure to change the display name of the currently selected input source.

Setting items	Setting contents								
Rename Change the input source's display name to the desired name.	<p>1. Use to set the cursor to the character you want to change. 2. Use to change the character, then press .</p> <ul style="list-style-type: none"> Up to 8 characters can be input. The input character type can be switched by pressing while the display name is being changed. The types of characters that can be input are as shown below. <table border="1"> <tbody> <tr> <td>[Capital letters]</td> <td>ABCDEFGHIJKLMNOPQRSTUVWXYZ</td> </tr> <tr> <td>[Small letters]</td> <td>abcdefghijklmnopqrstuvwxyz</td> </tr> <tr> <td>[Symbols]</td> <td>' () * + - . / : ; < = > ? []</td> </tr> <tr> <td>[Numbers]</td> <td>0123456789 (space)</td> </tr> </tbody> </table>	[Capital letters]	ABCDEFGHIJKLMNOPQRSTUVWXYZ	[Small letters]	abcdefghijklmnopqrstuvwxyz	[Symbols]	' () * + - . / : ; < = > ? []	[Numbers]	0123456789 (space)
[Capital letters]	ABCDEFGHIJKLMNOPQRSTUVWXYZ								
[Small letters]	abcdefghijklmnopqrstuvwxyz								
[Symbols]	' () * + - . / : ; < = > ? []								
[Numbers]	0123456789 (space)								
Default The changed display names are reset to the defaults.	<p>Yes : Reset to the defaults. No : Do not reset to the defaults.</p>								

Correcting the Input Source's Playback Level (Source Level)

Default settings are underlined.

Use this procedure to correct the playback level of the currently selected input source's audio input. Set this if there are differences in the input volume levels between the different sources.

Setting items	Setting contents
Source Level Correct the playback level of the audio input.	-12dB ~ +12dB (<u>0dB</u>)

Setting the iPod Playback Mode (iPod Playback Mode)

Default settings are underlined.

This can be selected for input sources for which "Assign" is assigned at the "iPod Dock" (page 31) setting.

Setting items	Setting contents
Repeat Make settings for repeat mode.	All : Repeat all songs. One : Repeat the current song. Off : Cancel repeat mode.
Shuffle Make settings for shuffle mode.	<input type="checkbox"/> When DENON control dock for iPod ASD-1R or ASD-11R is connected Songs : Shuffle all songs. Albums : Shuffle songs from current album only. Off : Cancel shuffle mode.

Presetting Radio Stations (Auto Preset)

Default settings are underlined.

Setting items	Setting contents
Auto Preset Use the auto preset function to program radio stations.	This can be set when the source is set to TUNER . Start : Start the auto preset process.  If an FM station cannot be preset automatically, select the desired station by tuning it in manually, then preset it manually.



Setting the Preset Channels to be Skipped (Preset Skip)

Default settings are underlined.

Setting items	Setting contents
Preset Skip Set the preset memories that you do not want to display when tuning.	This can be set when the source is set to TUNER . A ~ G : Select the preset channel(s) you do not want to display. • ON : Display this number. • Skip : Skip this number.  If you set "Block Presets" to "Skip", you can skip the preset memory blocks (A to G).

Assign Name to a Preset Memory (Preset Name)

Default settings are underlined.

Setting items	Setting contents
Preset Name Assign name to a preset memory.	This can be set when the source is set to TUNER . 1. Use $\Delta \nabla$ to select the preset channel name you want to change, then press . 2. Use $\triangleleft \triangleright$ to set the cursor to the character you want to change. 3. Use $\Delta \nabla$ to change the character, then press . <ul style="list-style-type: none"> Up to 8 characters can be input. The input character type can be switched by pressing  while the display name is being changed. The types of characters that can be input are as shown below. <div style="border: 1px solid black; padding: 5px; margin-top: 10px;"> <p>[Capital letters] ABCDEFGHIJKLMNOPQRSTUVWXYZ [Small letters] abcdefghijklmnopqrstuvwxyz [Symbols] ' () * + - . / : ; < = > ? [] [Numbers] 0123456789 (space)</p> </div>
	4. Repeat steps 2 and 3 to change the display name.

Playback

Operation Flow

Before starting playback, make the connections between the different components and the settings on the receiver.

Playing Components (☞ page 34)

- ☐ **Playing Blu-ray Disc/DVD Players** (☞ page 34)
- ☐ **iPod® Playback** (☞ page 34)
- ☐ **Listening to FM/AM Broadcasts** (☞ page 36)
- ☐ **Operations During Playback** (☞ page 37)



Selecting the Surround Mode (☞ page 37)

- ① **Standard Playback** (☞ page 37)
- ② **Playing in a DENON original surround mode** (☞ page 38)
- ③ **Direct Playback** (☞ page 38)
- ④ **Stereo Playback** (☞ page 39)



Adjusting the Sound Field Effects (Parameter) (☞ page 39)

NOTE

- Also refer to the operating instructions of the connected components when playing them.
- External devices can be controlled by remote control unit (☞ page 46 "Operating the Connected Devices by Remote Control Unit").

Playing Components

Playing Blu-ray Disc / DVD Players

The following describes the procedure for playing Blu-ray disc/DVD players.

Use the same procedure to play other components.

1 Prepare for playback.

- ① Turn on the power of the TV, subwoofer and player.
- ② Set the TV's input to the AVR-590.
- ③ Load the disc in the player.

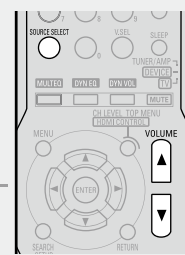

2 Turn on the AVR-590's power.

(☞ page 16 "Turning the Power On")

3 Press and select the input source.

If "TUNING PRESET" is selected for preset channel, press  before turning .

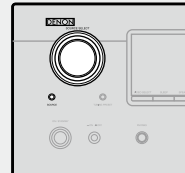

4 Play the component connected to the AVR-590.

Make the necessary settings on the player (language setting, subtitles setting, etc.) beforehand.

5 Use to adjust the volume.

[Variable range] --- -80.0dB ~ 18.0dB

※ The variable range differs according to the input signal and channel level setting.

6 Select the desired surround mode.

(☞ page 37 "Selecting the Surround Mode")

7 Adjust the desired sound field effects.

(☞ page 39 "Adjusting the Sound Field Effects")

iPod® Playback

The music / video on an iPod can be played by using the control dock for iPod (ASD-1R, ASD-11R, ASD-3N or ASD-3W sold separately).

Connect the control dock for iPod beforehand. (☞ page 14 "iPod®").

Listening to music on an iPod®

1 Prepare for playback.

- ① Set the iPod in the DENON control dock for iPod.
- ② Assign the control dock for iPod's input (☞ page 31).
- ③ Switch  to "DEVICE".

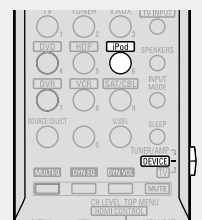

2 Turn on the AVR-590's power.

(☞ page 16 "Turning the Power On")

3 Press to select the input source assigned in step 1-② above.

※ If the screens above are not displayed, the iPod may not be properly connected. Try connecting again.

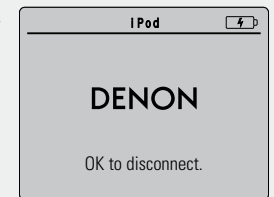

(iPod screen)

See overleaf

4 Press  and hold it down for a 2 seconds or more to select the display mode.

There are two modes for display the contents recorded on the iPod.



Browse mode : Displayed on the TV screen.

Remote mode : Displayed on the iPod's screen.

Display mode		Browse mode	Remote mode
Playable files	Audio file	<input type="radio"/>	<input type="radio"/>
	Video file	<input type="radio"/> * 1	<input type="radio"/> * 2
Active buttons	Remote control unit (AVR-590)	<input type="radio"/>	<input type="radio"/>
	iPod®	<input checked="" type="radio"/>	<input type="radio"/>

* 1 : When using an ASD-11R, ASD-3N or ASD-3W control dock for iPod.

* 2 : Video may not be output, depending on the combination of ASD-1R or ASD-11R and iPod.

5 Use  to select the menu, then press  or  to select the music or video file to be played.

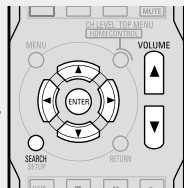

6 Press  or .
Playback starts.





7 Use  to adjust the volume.



[Variable range] --- -80.0dB ~ 18.0dB

※ The variable range differs according to the input signal and channel level setting.

8 Select the desired surround mode.
( page 37 "Selecting the Surround Mode")





9 Adjust the desired sound field effects.
( page 39 "Adjusting the sound Field Effects")

- To stop**
During playback, either press and hold  or press .
- Stopping playback temporarily**
During playback, press  or .
Press again to resume playback.

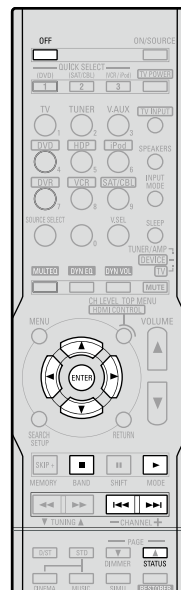
- To cue to the beginning of a track**
During playback,  either press (to cue to the current track) or  (to cue to the next track).

- Repeat playback and shuffle playback**
"iPod Playback Mode" ( page 33)



- Use the RESTORER mode to expand the low and high frequency components of compressed audio files and achieve a richer sound. The default setting is "Mode3" ( page 43).
- To check the name of the title, the artist or the album when playing in browse mode, press .
- The time (default : 30 sec) for which the on-screen display are displayed can be set at menu "iPod Information" ( page 29). Press  to return to the original screen.
- Press  and set the AVR-590's power to the standby mode before disconnecting the iPod. Also switch the input source to one to which the menu "iPod dock" is not assigned before disconnecting the iPod.

NOTE

- Depending on the type of iPod and the software version, some functions may not operate.
- DENON will accept no responsibility whatsoever for any loss of iPod data.

Viewing Still Pictures or Videos on the iPod®

- Photo and video data on the iPod can be viewed on the monitor. Only for iPod equipped with slideshow or video functions. (When using an ASD-1R or ASD-11R)
- Video may not be output, depending on the combination of ASD-1R or ASD-11R and iPod.

1 Press and hold  to set the Remote mode.

"Remote iPod" is displayed on the AVR-590's display.

2 Watching the iPod's screen, use  to select "Photos" or "Videos".

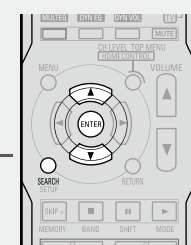

3 Press  until the image you want to view is displayed.



"TV Out" at the iPod's "Slideshow Settings" or "Video Settings" must be set to "On" in order to display the iPod's photo data or videos on the monitor. For details, see the iPod's operating instructions.



iPod is a trademark of Apple Inc., registered in the U.S. and other countries. The iPod may only be used to copy or play contents that are not copyrighted or contents for which copying or playback is legally permitted for your private use as an individual. Be sure to comply with applicable copyright legislation.

Listening to FM/AM Broadcasts

Basic Operation

1 Set to "TUNER/AMP".

2 Press to select "TUNER".

3 Press to select "FM" or "AM".

4 Tune in the desired broadcast station.

① To tune in automatically (Auto Tuning)

Press to light the "AUTO" indicator on the display, then use to select the station you want to hear.

② To tune in manually (Manual Tuning)

Press to turn off the display's "AUTO" indicator, then use to select the station you want to hear.

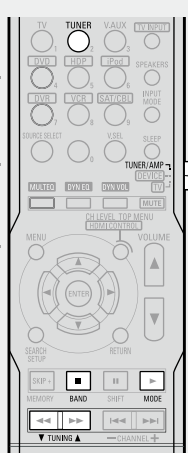

- If the desired station cannot be tuned in with auto tuning, tune it manually.
- When tuning in stations manually, press and hold to change frequencies continuously.
- The time (default : 30 sec) for which the on-screen display are displayed can be set at "On-Screen Display" (page 29).

Presetting Radio Stations (Preset Memory)

Your favorite broadcast stations can be preset so that you can tune them in easily. Up to 56 stations can be preset.

1 Tune in the broadcast station you want to preset.

2 Press .

3 Press to select the block (A to G) in which the station is to be preset.

4 Press to select the preset number (1 to 8).

5 Press again to complete the setting.

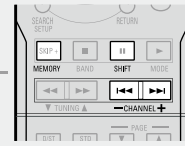

- To preset other stations, repeat steps 1 to 5.
- Stations can be preset automatically at menu "Auto Preset" (page 33).

NOTE

Preset stations are erased by overwriting them.

Listening to Preset Stations

1 Press to select the memory block (A to G).

2 Press to select the desired preset channel (1 to 8).

Default settings

Auto tuner presets	
A1 ~ A8	87.5 / 89.1 / 98.1 / 107.9 / 90.1 / 90.1 / 90.1 / 90.1 MHz
B1 ~ B8	520 / 600 / 1000 / 1400 / 1500 / 1710 kHz, 90.1 / 90.1 MHz
C1 ~ C8	90.1 MHz
D1 ~ D8	90.1 MHz
E1 ~ E8	90.1 MHz
F1 ~ F8	90.1 MHz
G1 ~ G8	90.1 MHz



You can also operate via the main unit. In this case, perform the following operations.

- Press , then turn on the main unit to select the preset radio channel.

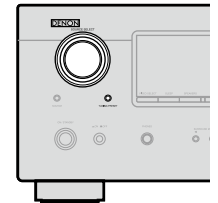

Playing Components

Operations During Playback

Turning Off the Sound Temporarily (Muting)

Press **MUTE**.

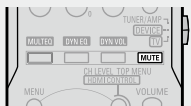

- The sound is reduced to the level set at menu "Mute Level" (page 28).
- To cancel, press **MUTE** again. Muting can also be canceled by adjusting the master volume.

Listening with Headphones

Plug the headphones into the PHONES jack on the main unit.

The sound from the speakers and pre-out connectors is automatically cut.



NOTE

- To prevent hearing loss, do not raise the volume level excessively when using headphones.
- Unplug headphones when performing the Audyssey Auto Setup procedure or other settings.

Switching the brightness of the display

Press **DIMMER**.

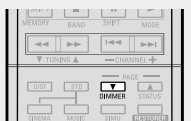
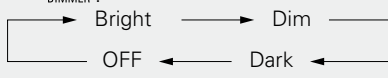

Selecting the Surround Mode

Select a surround mode to enjoy surround playback with your favorite sound field effects.

1 Playing sources according to the sources' audio signal format/number of channels (Standard Playback)

Operations

The selectable surround modes depend on the following:

- Format of the audio signals being input
- Number of channels of the audio signals being input
- The set pre out assignment mode (page 24)

1 Playing the source (page 34).

2 Press **STD** to select the surround mode.

Multichannel sources

The surround modes that can be selected differ according to the input source.

2channel sources

When you select "DOLBY PLIIz"; set "Pre Assign" to "Front Height".

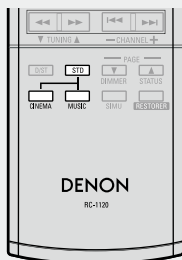

**DOLBY PLIIx,
DOLBY PLII
OR
DOLBY PLIIz**

* : The signals are decoded in DOLBY PLIIx, DOLBY PLII or DOLBY PLIIz, for playback.

DTS NEO:6

: The signals are decoded in DTS NEO:6 for playback.

* : DOLBY PLIIx can be selected when surround back speakers are being used.

3 This is the operation for playing 2-channel sources.

Select the mode for the source at "Mode" (page 39).

DOLBY PLIIx, DOLBY PLII

Cinema : This mode is suited for movie sources.

Music : This mode is suited for music sources.

Game : This mode is suited for games.

Pro Logic : This is the Pro Logic playback mode. This can be selected when playing with a DOLBY PLII decoder. When this mode is selected, "DOLBY PL" is displayed.

DTS NEO:6

Cinema : This mode is suited for movie sources.

Music : This mode is suited for music sources.

* : The modes that can be selected depend on the input source being played.



The "Cinema" and "Music" modes can also be set by pressing **CINEMA** or **MUSIC**.

Displaying the currently playing surround mode

Surround playback of multichannel sources (Dolby Digital, DTS, etc.)

In the case of standard playback of multi channel sources, the AVR-590 recognizes the format of the multi-channel audio input signal and automatically operates the appropriate decoder for surround sound.

	Input signal	Display
Dolby Digital	Dolby Digital (other than 2ch)/ Dolby Digital EX	DOLBY DIGITAL
		DOLBY DIGITAL EX
		DOLBY DIGITAL+PLIIx CINEMA
		DOLBY DIGITAL+PLIIx MUSIC
	Dolby Digital Plus (* 1)	DOLBY DIGITAL+PLIIz
		DOLBY DIGITAL++PLIIx C
		DOLBY DIGITAL++PLIIx M
	Dolby TrueHD (* 1)	DOLBY DIGITAL++PLIIz
		DOLBY TrueHD
		DOLBY HD+EX
DOLBY HD+PLIIx CINEMA		
DTS	DTS (5.1ch)/ DTS-ES Discrete 6.1 / DTS-ES Matrix 6.1 / DTS 96/24	DOLBY HD+PLIIx MUSIC
		DOLBY HD+PLIIz
		DTS SURROUND
		DTS+PLIIx CINEMA
		DTS+PLIIx MUSIC
		DTS+PLIIz
		DTS+NEO:6
	DTS-HD (* 1)	DTS ES MTRX6.1 (* 2)
		DTS ES DSCRT6.1 (* 3)
		DTS 96/24 (* 4)
		DTS-HD HI RES
		DTS-HD MSTR
		DTS-HD+NEO:6
PCM	PCM (multi ch)	DTS-HD+PLIIx CINEMA
		DTS-HD+PLIIx MUSIC
		DTS-HD+PLIIz
		MULTI CH IN
		MULTI IN+PLIIx CINEMA
		MULTI IN+PLIIx MUSIC
		MULTI IN+PLIIz
MULTI CH IN 7.1		

- * 1 : When a signal is input, the HD AUDIO indicator lights.
- * 2 : This is displayed when the input signal is "DTS-ES Matrix 6.1" and the AVR-590's "AFDM" setting (page 40) is set to "ON".
- * 3 : This is displayed when the input signal is "DTS-ES Discrete 6.1".
- * 4 : This is displayed when the input signal is "DTS 96/24".

Playing in a DENON original surround mode

The desired mode according to the program source and viewing situation can be selected from among 7 DENON original surround modes.

1 Select the input source by pressing SOURCE SELECT and play the source (page 34).

2 Press SIMU to select the Surround mode.

5CH/7CH STEREO : This mode is for enjoying stereo sound from all speakers.

ROCK ARENA : This mode is for enjoying the atmosphere of a live concert in an arena.

JAZZ CLUB : This mode is for enjoying the atmosphere of a live concert in a jazz club.

MONO MOVIE : This mode is for playing monaural movie sources with surround sound. * 1

VIDEO GAME : This mode is suited for achieving surround sound with video games.

MATRIX : This mode lets you add a sense of expansion to stereo music sources.

VIRTUAL : This mode is for enjoying surround effects using only the front speakers or headphones.

* 1 : When playing sources recorded in monaural in the MONO MOVIE mode, the sound will be off balance with a single channel (left or right), so input to both channels.



Depending on the program source being played, it may not be possible to achieve a satisfactory surround effect. In this case, try other modes to achieve a sound field suited to your tastes.

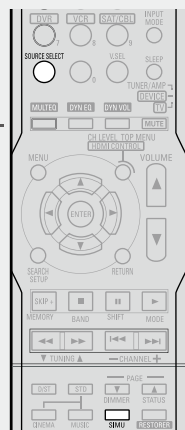

NOTE

When the input signal is DOLBY TrueHD, DOLBY DIGITAL Plus, DTSHD you cannot select DENON original surround mode.

Direct Playback

In this mode the signals bypass the tone adjustment circuitry for high quality sound. The sound is output to the same channels as the input signal.

1 Select the input source by pressing SOURCE SELECT and play the source (page 34).

2 Press D/ST to select the "DIRECT".

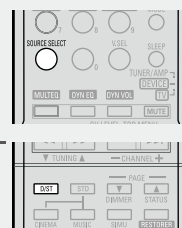

Displaying the currently playing surround mode

Input signal	Display
Analog signal / PCM (2ch) / Dolby Digital source / DTS source / Other 2-channel digital signals	DIRECT
PCM (multi ch)	MULTI CH DIRECT
	M DIRECT + PLIIx CINEMA
	M DIRECT + PLIIx MUSIC
	M DIRECT + PLIIz
	M DIRECT 7.1

Selecting the Surround Mode

④ Stereo Playback

This is the mode for playing in stereo. The tone can be adjusted. Sound is output from the front left and right speakers and subwoofer.

1 Select the input source by pressing SOURCE SELECT and play the source (page 34).

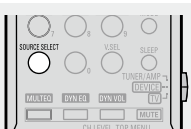

2 Press D/ST to select the "STEREO".



Adjusting the Sound Field Effects (Parameter)

The sound being played in the surround mode can be adjusted to your liking. The items (parameters) that can be adjusted depend on the signal being input and the currently set surround mode. For details on the adjustable parameters, see "Surround Modes and Parameters" (page 51).

NOTE

Some of the setting items cannot be set while playback is stopped. Set these items during playback.

Adjusting the sound field effects (Surround Parameter)

Default settings are underlined.

Setting items	Setting contents
Mode Set the play mode for playing 2-channel sources in surround.	<input type="checkbox"/> In the PLIIx, PLII or PLIIz mode Cinema : This is the mode for cinema source. Music : This is the mode for music source. Game : This is the mode for game source. ProLogic : Dolby Pro Logic playback mode (PLII mode only). (This is the mode for 4-channel playback (front L, front R, center, surround (MONO)).) <input type="checkbox"/> In the DTS NEO:6 mode Cinema : This is the mode for cinema source. Music : This is the mode for music source. <ul style="list-style-type: none"> The "Music" mode is also effective for movie sources including a lot of stereo music. The "Cinema" and "Music" modes can also be set by pressing or .
Cinema EQ Soften the treble range of movie sound tracks for better understanding.	OFF : "Cinema EQ" is not used. ON : "Cinema EQ" is used.
Dynamic Range Compression (D.Comp) Compress dynamic range (difference between loud and soft sounds).	Low/Mid/High : These set the compression level. OFF : Turn dynamic range compression off. The "D.Comp" indicator lights when playing DTS source that supports the "D.Comp" function.
Dynamic Range Control (DRC) Compress dynamic range	Auto : Dynamic range compression of Dolby TrueHD sources turns on and off automatically. Low/Mid/High : These set the compression level. OFF : Turn dynamic range compression off.
LFE Adjust the low-frequency effects level (LFE).	-10dB ~ 0dB For proper playback of the different program sources, we recommend setting to the values below. <ul style="list-style-type: none"> Dolby Digital sources : "0dB" DTS movie sources : "0dB" DTS music sources : "-10dB"



Adjusting the Sound Field Effect (Parameter)

Setting items	Setting contents
Center Image Assign center channel signal to front left and right channels for wider sound.	0.0 ~ 1.0 (0.3)
Panorama Assign front L/R signal also to surround channels, for wider sound.	ON : Set. OFF : Do not set.
Dimension Shift sound image center to front or rear, to adjust playback balance.	0 ~ 6 (3)
Center Width Assign center channel signal to front left and right channels for wider sound.	0 ~ 7 (3)
Delay Time Adjust delay time to control sound stage size.	0ms ~ 300ms (30ms)
Effect Level Adjust the strength of the surround effect.	1 ~ 15 (10) Set to a lower level if the positioning and sense of phase of the surround signals seems unnatural.
Room Size Determine size of acoustic environment. NOTE "Room Size" does not indicate the size of the room in which sources are played.	Small : Simulate acoustics of a small room. Medium small : Simulate acoustics of a medium-small room. Medium : Simulate acoustics of a medium room. Medium large : Simulate acoustics of a medium-large room. Large : Simulate acoustics of a large room.

Setting items	Setting contents
AFDM (Auto Flag Detect Mode) Detects the source's surround back channel signal and sets the optimum surround mode automatically.	ON : Set. OFF : Do not set.
Surround Back Sets the method of generating of the surround back channel.	<input type="checkbox"/> For 2-channel sources ON : The surround back channel is used. OFF : No signal is played from the surround back channels. <input type="checkbox"/> For multi channel sources Set this to set the method of generating of the surround back channel for sources that do not include surround back signals and when you do not want to play the surround back signals included in the source. Check the audio signals of the source being played before making this setting. OFF : No signal is played from the surround back channels. MTRX ON : Generate and play the surround back signals from the surround channel signals. PLIIx CINEMA*1 : Generate and play the surround back signals by decoding the signals in the "Dolby Pro Logic IIx Cinema" mode. PLIIx MUSIC*2 : Generate and play the surround back signals by decoding the signals in the "Dolby Pro Logic IIx Music" mode. ES MTRX : Generate and play the surround back signals from the surround channel signals of the DTS source. ES DSCRT*3 : Play the surround back signals included in the 6.1-channel DTS source. DSCRT ON*3 : Play the surround back signals included in the 7.1-channel source. *1 : This can be selected when "S.Back" in the "Speaker Config." settings (🔧 page 25) is set to "2ch". *2 : This can be selected when "S.Back" in the "Speaker Config." settings (🔧 page 25) is set to "2ch" or "1ch". *3 : When "AFDM" is set to "ON", the surround back channel is played with the AFDM function. When selected while "AFDM" is set to "OFF", the source's surround back signals are played. This can also be set by pressing [STD] .
	NOTE This is valid when the "Pre Assign" setting (🔧 page 24) is set to "7.1-channel surround back" or "6.1-channel surround back", and when the "S.Back" setting (🔧 page 25) is set to "Large" or "Small".

Setting items	Setting contents
Front Height Set whether or not to use the front height channel.	ON : Use the front height channel. OFF : Do not use the front height channel. This can also be set by pressing  .
Subwoofer Turn subwoofer output on and off.	ON : The subwoofer is used. OFF : The subwoofer is not used.
Default Restores all the surround parameter settings to their defaults.	Yes : Reset to the defaults. No : Do not reset to the defaults.

Adjusting the tone (Tone Control) Default settings are underlined.

Setting items	Setting contents
Tone Control Sets the tone control function ON and OFF. This can be set when "Dynamic EQ" ( page 42) is set to "OFF".	ON : Allow tone adjustment (treble, bass). OFF : Playback without tone adjustment.  The tone cannot be adjusted when in the DIRECT mode.
Bass Adjusts the low frequencies. This can be set when "Tone Control" is set to "ON".	-6dB ~ +6dB (0dB)
Treble Adjusts the high frequencies. This can be set when "Tone Control" is set to "ON".	-6dB ~ +6dB (0dB)

Making the MultEQ, Dynamic EQ and Dynamic Volume settings (Audyssey Settings) Default settings are underlined.



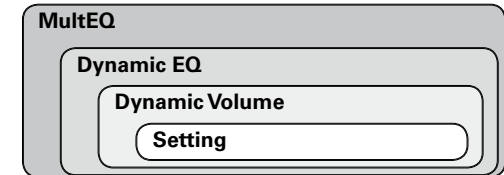

- When the "Audyssey Auto Setup" ( page 19) procedure is performed, the "MultEQ", "Dynamic EQ" and "Dynamic Volume" functions are enabled.
- **Operating conditions for each function**
 - **Dynamic EQ** :
When "MultEQ" is set to "ON"
 - **Dynamic Volume** :
When "Dynamic EQ" is set to "ON"
 - **Setting** :
When "Dynamic Volume" is set to "ON"





NOTE

If the speaker settings are changed after the "Audyssey Auto Setup" procedure is performed, "MultEQ", "Dynamic EQ" and "Dynamic Volume" functions cannot be selected and "Run Audyssey" is displayed.

If this happens, either perform the "Audyssey Auto Setup" procedure again, or perform the "Restore" operation ( page 23) to restore the settings to as they were after the "Audyssey Auto Setup" procedure was performed.

Setting items	Setting contents
MultEQ Corrects the frequency response of the different speakers.	Audyssey : Optimize frequency response of all speakers. Audyssey Byp.L/R : Optimize frequency response of speakers except front L and R speakers. Audyssey Flat : Optimize frequency response of all speakers to flat response. Manual : Apply frequency response set with "Manual EQ" ( page 42). OFF : The "MultEQ" equalizer cannot be used.
NOTE	 • When "Audyssey", "Audyssey Byp. L/R" or "Audyssey Flat" is selected, "  " lights. • After running Audyssey Auto Setup, if the Speaker Configuration, Distance, Channel Level, and Crossover Frequency have changed without increasing the number of speakers measured, only "  " lights. • This can also be set by pressing  .

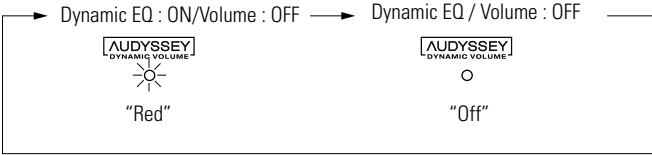
Adjusting the Sound Field Effect (Parameter)

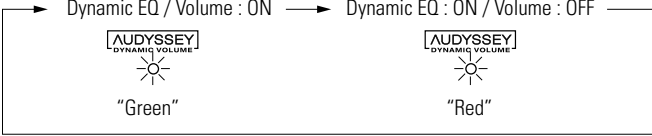
Setting items	Setting contents
<p>Dynamic EQ</p> <p>Audyssey Dynamic EQ solves the problem of deteriorating sound quality as volume is decreased by taking into account human perception and room acoustics.</p> <p>This can be set when the "MultEQ" (page 41) is set to anything other than "OFF".</p>	<p>ON : Use Dynamic EQ function. OFF : Do not use Dynamic EQ function.</p> <ul style="list-style-type: none"> When set to "ON", "AUDYSSEY MULTEQ DYN EQ" is displayed. When "MultEQ" is set to "OFF", "Dynamic EQ" is automatically set to "OFF" This can also be set by pressing . <p>Dynamic EQ : ON/Volume : OFF → Dynamic EQ / Volume : OFF</p>  <p>NOTE</p> <p>"Tone Control" is set to "OFF" when "Dynamic EQ" is set to "ON".</p> <p>Reference Level Offset : Audyssey Dynamic EQ takes the standard film mixing level of 85 dB SPL during -20 dB FS input as its reference level. However, since standardization is lacking outside the film industry, the reference level of media contents may not be appropriate. In order to view such contents, Reference Level Offset of Dynamic EQ has available offsets of 5 dB, 10 dB and 15 dB.</p> <ul style="list-style-type: none"> 0dB : Suitable for viewing movies. 5dB : Suitable for listening to classical music and other content mixed at a high level. 10dB : Suitable for listening to jazz and other audio sources with a wide dynamic range. Also suitable for viewing TV. 15dB : Suitable for listening to pop, rock music and other content with an extremely wide dynamic range. <p> Setting is enabled when "Dynamic EQ" is "ON".</p>
<p>Dynamic Volume</p> <p>Audyssey Dynamic Volume solves the problem of large variations in volume level between television programs, commercials, and between the soft and loud passages of movies.</p> <p>This can be set when "Dynamic EQ" (page 42) is set to "ON".</p>	<p>ON : Use Dynamic Volume. The Dynamic Volume effect will be at the level of the "Setting" (page 42) OFF : Do not use Dynamic Volume.</p> <ul style="list-style-type: none"> When set to "ON", "AUDYSSEY MULTEQ DYN VOL" is displayed. When "MultEQ" is set to "OFF", "Dynamic Volume" is automatically set to "OFF". This can also be set by pressing . <p>Dynamic EQ / Volume : ON → Dynamic EQ : ON / Volume : OFF</p> 

Setting items	Setting contents
<p>Setting</p> <p>Set Dynamic Volume effect.</p> <p>This can be set when "Dynamic EQ" (page 42) is set to "ON".</p>	<p>Day : Low setting provides the least adjustments to the loudest and softest of sounds. Evening : Middle setting prevents loud and soft sounds from being much louder and softer respectively than average sounds. Midnight : High setting affects volume the most, causing all sounds to be of equal loudness.</p>

Adjust tonal quality for each speaker using graphic equalizer (Manual EQ)

Default settings are underlined.

Setting items	Setting contents
<p>Adjust CH</p> <p>Adjust the tonal quality of the individual speakers.</p>	<p>1. Select speaker adjustment method. All CH : Adjust tonal quality for all speakers together. L/R CH : Adjust tonal quality for each L/R speaker pair. Each CH : Adjust tonal quality for each speaker separately.</p> <p>2. Select the frequency band to be adjusted. <u>63Hz</u> / <u>125Hz</u> / <u>250Hz</u> / <u>500Hz</u> / <u>1kHz</u> / <u>2kHz</u> / <u>4kHz</u> / <u>8kHz</u> / <u>16kHz</u> ※ When "L/R CH" or "Each CH" is selected, select the speaker to be adjusted.</p> <p>3. Adjust the level. <u>-20.0dB</u> ~ <u>+6.0dB</u> (<u>0dB</u>)</p>
<p>Base Curve Copy</p> <p>Copy the MultEQ "Audyssey Flat" correction curve.</p>	<p>Yes : Copy. No : Do not copy.</p> <p> "Base Curve Copy" is displayed after the Audyssey Auto Setup procedure has been performed.</p>
<p>Default</p> <p>Reset the "Manual EQ" settings to their defaults.</p>	<p>Yes : Reset to the defaults. No : Do not reset to the defaults.</p>

Adjusting the Sound Field Effect (Parameter)

Restoring compressed audio to nearly pre-compressed conditions for playback (RESTORER)

Default settings are underlined.

- Such compressed audio formats as MP3, WMA (Windows Media Audio) and MPEG-4 AAC reduce the amount of data by eliminating signal components that are hard for the human ear to hear. The RESTORER function generates the signals eliminated upon compression, restoring the sound to conditions near those of the original sound before compression. It also corrects the sense of volume of the bass to obtain richer sound with compressed audio signals.
- This can be set with analog signals or when a PCM signal (fs = 44.1/48 kHz) is input.

Setting contents

OFF : Do not use RESTORER.

Mode1 (RESTORER 64) : Optimized mode for compressed sources with very weak highs.

Mode2 (RESTORER 96) : Apply suitable bass and treble boost for all compressed sources.

Mode3 (RESTORER HQ) : Optimized mode for compressed sources with normal highs.

- The default setting for "iPod" is "Mode3". All others are set to "OFF".
- When set to something other than "OFF", "RSTR" is displayed.

- This can also be set by pressing  during playback.

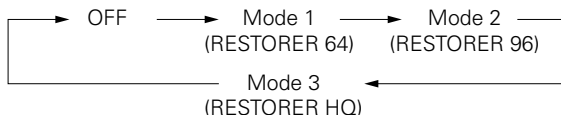

Adjusting the audio delay time while watching the picture (Audio Delay)

Default settings are underlined.



Setting contents

0ms ~ 200ms

- If you wish to adjust the "Audio Delay" while playing HDMI or component video signals, press Δ to set "OSD" to "OFF". This way the audio delay can be adjusted while watching the picture. (Press the Δ again. The display switches to the display of the menu screen only.)
- This cannot be adjusted when playing in the DIRECT or STEREO mode (with "Front Speaker" set to "Large", "Tone Control" to "OFF" and "MultEQ" and "RESTORER" to "OFF").
- When the Auto Lipsync Correction function is operating, you can set within the range 0 ~ 100 ms.
- Store "Audio Delay" for each input source.



Checking the Status (Information)

Setting items	Setting contents
Status Shows information about current settings.	Select Source / Surround Mode / Input Mode / Decode Mode / HDMI / Digital / Component / iPod Dock / Video Select / Source Level  You can also display current status on the main unit's display each time you press  .
Audio Input Signal Shows information about audio input signals.	Surround Mode : The currently set surround mode is displayed. Signal : The input signal type is displayed. fs : The input signal's sampling frequency is displayed. Format : The number of channels in the input signal (front, surround, LFE) is displayed. Offset : The dialogue normalization correction value is displayed. Flag : This is displayed when inputting signals including a surround back channel. "MATRIX" is displayed with Dolby Digital EX and DTS-ES Matrix signals, "DISCRETE" with DTS-ES Discrete signals.
HDMI Information Shows information about HDMI input signals and monitor.	HDMI Signal Information • Resolution / Color Space / Pixel Depth HDMI Monitor Information • Interface / Support Resolution
Auto Surround Mode Shows information about auto surround mode settings.	Analog/PCM / Digital 2ch / Digital 5.1ch / Multi CH
Quick Select Shows information about quick select settings.	Quick Select 1 / Quick Select 2 / Quick Select 3 • Name / Input Source / Video Select / Volume Level / MultEQ / Dynamic EQ / Dynamic Vol / Analog/PCM / Digital 2ch / Digital 5.1ch / Multi CH
Preset Channel Shows information about preset channels.	A 1 ~ G 8 • TUNER

Convenient functions

HDMI Control Function

When you make an HDMI connection with a TV or player compatible with AVR-590 and HDMI control functions, you can perform the following operations by setting the HDMI control function of each device.

- AVR-590 power off can be linked to the TV power off step**
 - * When you set "Output audio from amp" in the TV audio output setup operation, you can switch the amp power on.
- You can switch audio output devices with a TV operation**
- You can adjust AVR-590 volume in the TV volume adjustment operation**
- You can switch AVR-590 input source through linkage to TV input switching**
- When playing the player, the AVR-590 input function switches to the function of that player**



- To play the TV's sound on the AVR-590, make optical digital connections (page 13 "Connecting the TV").
- To use this function, set "HDMI Control" (page 27) to "ON".

NOTE

- When you power off AVR-590, the HDMI control function does not operate.
- Some functions may not operate depending on the connected TV or player. Check the owner's manual of each device for details beforehand.
- When "HDMI Control" is set to "ON", it is not possible to assign an HDMI connector to "TV" at "HDMI" (page 27).

1 Turn the power on for all the equipment connected by HDMI cable.

2 Set the HDMI control function for all equipment connected by HDMI cable.

Set "HDMI Control" (page 27) to "ON".

- ※ Please refer to the owner's manual as regards setting of connected devices.
- ※ Carry out Steps 1 and 2 should any of the equipment be unplugged.

3 Switch the television input to the HDMI connected to the AVR-590.

4 Switch the AVR-590 input to the HDMI input source and check if the picture from the player is ok.

5 When you turn the TV's power to standby, check that the power of the AVR-590 and player also goes on standby.



If the HDMI control function does not operate properly, check the following points.

- Is the TV or player compatible with the HDMI control function?
- Is the AVR-590 properly set?
 - Is "HDMI Control" (page 27) set to "ON"?
 - Is "Power Off Control" (page 27) set to "ON"?
- Are the HDMI control function settings of all equipment correct?

NOTE

Should any of the operations below be performed, the interlocking function may be reset, in which case, repeat step's 1 and 2.

- Menu "HDMI" (page 27) setting has changed.
- There is a change to the connection between the equipment and the HDMI, or an increase in equipment.

Setting the power to standby after a certain amount of time (Sleep Timer Function)

This function allows you to automatically set the power to standby after the set amount of time has passed.

Press  and display the time you want to set.

The "SLEEP" indicator on the display lights.

- The time switches as shown below each time  is pressed.

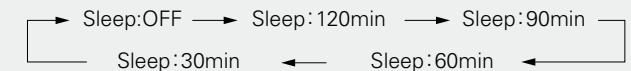

- The time display turns off after about 5 seconds, and the setting is activated.
- Once the set time has passed, the power is automatically set to standby.

To cancel the sleep timer

Press  to set "OFF".

- The "SLEEP" indicator on the display turns off.



Playing the picture of a different input source without changing the currently playing sound (Video Select Function)

Switch video input source while listening to audio signal.

Press  until the desired picture appears.

※ To cancel, press  to select "SOURCE".



NOTE

- It is not possible to select HDMI input signals.
- When playing HDMI video input signals, the analog video signal of another input source cannot be selected for the HDMI video output.
- Input sources for which "Delete" is selected at "Source Delete" (page 28) cannot be selected.
- Input sources for which "None" is selected at "Assign" (page 31) cannot be selected.

Adjust the volume of the different speakers

You can adjust the channel level either according to the playback sources or to suit your taste, as described below.

Adjust the volume of the different speakers

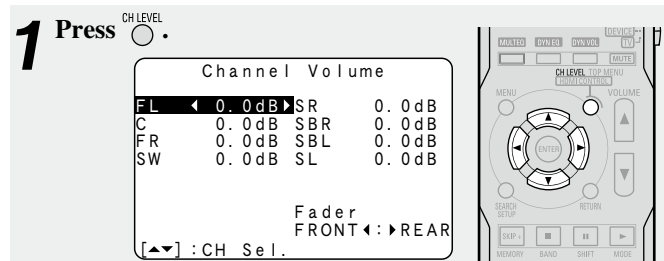

1 Press **CH LEVEL**.
2 Press **△**/**▽** to select the speaker.
 The speaker that can be set switches each time one of the buttons is pressed.

3 Press **◀**/**▶** to adjust the volume.
 ※ In the case of a subwoofer, reducing the volume when it is at “-12 dB” will change the setting to “OFF” (none).

If headphones are plugged in, the headphones settings screen appears.

Adjusting the volume of groups of speakers (Fader Function)

This function lets you adjust (fade) the sound from all the front (Front speaker / center speaker / Front Height speaker) or rear (Surround speaker / Surround Back speaker) speakers at once.

1 Use **CH LEVEL** or **▽** to select “Fader”, then select the item to be adjusting using **◀** or **▶**.

2 Press **◀**/**▶** to adjust the volume of the speakers.

The fader function does not affect the subwoofer.
 The fader can be adjusted until the volume of the speaker adjusted to the lowest value is -12 dB.

Saving frequently used settings (Quick Select Function)

This function allows you to save all the settings shown in step 1. When frequently used settings are saved, they can easily be set again the next time you want to use them. This function also allows you to always enjoy the same playback environment.

- Three sets of settings can be saved.

Saving the settings

- 1** Set the items below to the settings you want to save.
- ① Input source (☞ page 34)
 - ② Input Mode (☞ page 32)
 - ③ Surround Mode (☞ page 37)
 - ④ Audyssey Settings (MultEQ, Dynamic EQ, Dynamic Volume) (☞ page 41)
 - ⑤ Volume setting (☞ page 34)

2 Press and hold the desired **QUICK SELECT** (DVD) (SAT/CBL) (VCR/iPod) **1** **2** **3** until “Memory” appears on the display.
 The current settings will be memorized.

[Quick Select Defaults]

	Input Source	Volume
Quick Select 1	DVD	-40 dB
Quick Select 2	SAT/CBL	-40 dB
Quick Select 3	VCR/iPod	-40 dB

Calling the settings out

Press the **QUICK SELECT** (DVD) (SAT/CBL) (VCR/iPod) **1** **2** **3** at which the settings you want to call out are saved.

NOTE
 Input sources stored with the quick select function cannot be selected if they have been deleted at menu “Source Delete” (☞ page 28). In this case, store them again.

☐ Naming Quick Select settings

“Quick Select Name” (☞ page 29).

Various memory functions

Personal Memory Plus Function

This function sets the settings (input mode, surround mode, MultEQ, Dynamic EQ, Dynamic Volume, audio delay etc.) last selected for the individual input sources.

Last Function Memory

This stores the settings as they were directly before the standby mode was set.

When the power is turned back on, the settings are restored to as they were directly before the standby mode was set.

Backup Memory

The various settings are backed up for about 1 week, even if the power is turned off or the power cord is disconnected.

Operating the Connected Devices by Remote Control Unit

Registering Preset Codes







DENON and other makes of components can be operated by setting the preset memory.

⚠ Cautions during operation



When registering a preset code, point the remote control transmitter toward the AVR-590. The status of the registration operation is displayed on the AVR-590.

1 Press the source select button (see below) for the device to be registered and  simultaneously for over 2 seconds.

“RC SETUP START” appears on the display and the remote control unit is set to the preset code registration mode.

- | | |
|---|--|
|  : TV |  : Digital video recorder |
|  : DVD player or CD player |  : Video deck |
|  : Blu-ray disc player |  : Satellite receiver or cable TV |



2 Press  ~  and input the 3-digit number of the brand of the component to be preset. The numbers are shown in the Preset Code Table (End of this manual).

When registration is completed, “RC SETUP OK” appears on the display.

⚠ If the codes could not be registered, “RC SETUP NG” appears on the display. Try again.

3 To store the codes of another component in the memory, repeat steps 1 to 2.

⚠ For details, refer to the component’s operating instructions.



- Some manufacturers use more than one type of remote control code. Refer to the included list of preset codes to change the number and verify correct operation.
- The preset memory can be set for one component only among the following: DVD/CD and SAT/CBL.

Operating Registered Devices

1 Switch  to the device to be operated.

- TUNER/AMP** : To operate a Tuner
- DEVICE** : To operate a Blu-ray disc player, DVD player, CD player, Digital video recorder, Video deck, iPod, Satellite receiver or cable TV
- MAIN/TV** : To operate a TV

2 When “DEVICE” has been selected in step 1, press the source select button for the device to be operated.

The remote control unit is set to the device mode for the device to be operated. When the remote control transmitter is pointed towards the AVR-590 at this time, the AVR-590’s input source switches simultaneously.

⚠ The remote control unit stays in the same device mode until a different source select button is pressed.

3 Operate the component.

⚠ For details, refer to the component’s operating instructions.







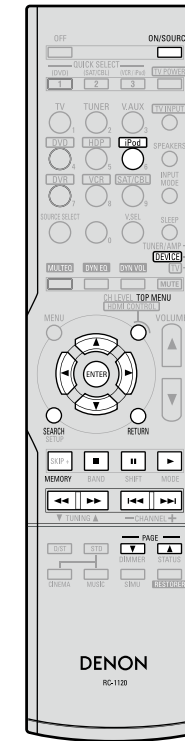

NOTE

Depending on the model and year of manufacture, this function cannot be used for some models, even if they are of makes listed in the list of preset codes.

Operating Registered Devices

iPod







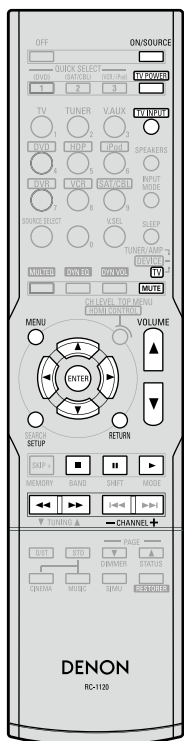

Operation mode setting		
ON/SOURCE	Power on / Standby *1	
	Play / Pause	
	Stop	
	Pause	
MEMORY	MEMORY *1	
TOP MENU	Calling out the top menus *1	
	Manual search (fast-reverse / fast-forward)	
	Auto search (cue)	
	Cursor	
ENTER	Enter	
SEARCH	Press and hold	Once
	Browse/Remote mode switching	Page search mode switching *2
RETURN	Return	
PAGE ▲ ▼	Page up/down *1	

*1 : This operation is possible when using a DENON ASD-3N or ASD-3W Control Dock for iPod.

*2 : This operation is possible when using a DENON ASD-1R or ASD-11R Control Dock for iPod.

TV



Operation mode setting	
ON/SOURCE	Power on / Standby
TV/POWER	Power on / Standby * 1
	Play * 2
	Pause * 2
	Stop * 2
	Manual search * 2 (fast-reverse / fast-forward)
CHANNEL + -	Switch channels (+, -)
TV INPUT	Switching the input * 1
VOLUME ▲▼	▲ : TV Volume (+) ▼ : TV Volume (-)
MUTE	TV MUTE
MENU	Calling out the menus
	Cursor operation
ENTER	Enter setting
SETUP	Setup
RETURN	Return
Default setting (Preset code)	SONY (374)
Special Remarks	①

* 1 : This can be operated even when the operation mode is set to something other than "TV".







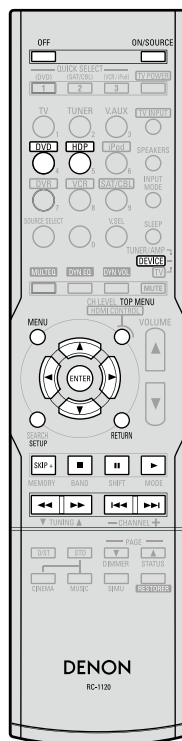

* 2 : When the punch through function (page 48) is set, this functions as the button for the device for which punch through is set.

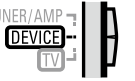
[Special Remarks]

- ① Only one device can be set in the preset memory for each mode. When a new preset code is registered, the existing code is automatically erased.
- ② For some brands, the DVD remote control buttons may have different function names. Check beforehand.







Blu-ray Disc / DVD Player

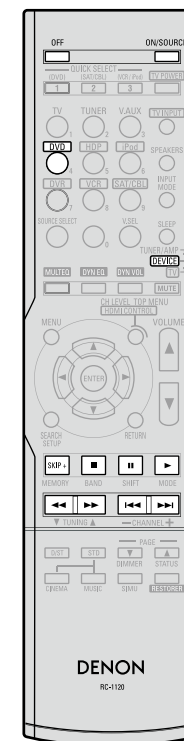

Operation mode setting		
OFF	Standby	
ON/SOURCE	Power on or Power on / Standby	
	Play	
	Stop	
	Pause	
SKIP +	BD Player	DVD Player
	-	Disc skip
	Manual search (fast-reverse / fast-forward)	
	Auto search (cue)	
MENU	BD Player	DVD Player
	Pop up menus	Menus
	Cursor operation	
ENTER	Enter setting	
SETUP	Setup	
RETURN	Return	
TOP MENU	Top menus	
Default setting (Preset code)	BD Player	DVD Player
	DENON (111)	DENON (111)
Special Remarks	①, ②	

CD Player



Operation mode setting	
OFF	Standby
ON/SOURCE	Power on or Power on / Standby
	Play
	Stop
	Pause
SKIP +	Disc skip +
	Manual search (fast-reverse / fast-forward)
	Auto search (cue)
Default setting (Preset code)	-
Special Remarks	①

Digital Video Recorder / Video Deck

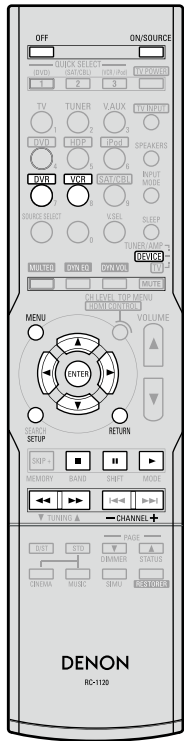

Operation mode setting	TUNER/AMP	DEVICE	TV	DVR	VCR
ON/SOURCE	Power on / Standby				
	Play				
	Stop				
	Pause				
	Manual search (fast-reverse / fast-forward)				
CHANNEL + -	Switch channels (+, -)				
MENU	Menus				
	Cursor operation				
ENTER	Enter setting				
SETUP	Setup				
RETURN	Return				
Default setting (Preset code)	Digital Video Recorder		Video Deck		
	JVC (001)		HITACHI (111)		
Special Remarks	①, ②				

[Special Remarks]

- ① Only one device can be set in the preset memory for each mode. When a new preset code is registered, the existing code is automatically erased.
- ② For some brands, the DVD remote control buttons may have different function names. Check beforehand.

Operating Registered Devices

Satellite receiver/Cable TV

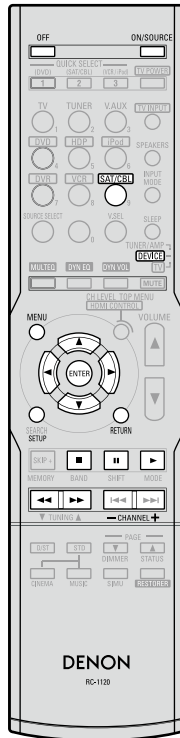

Operation mode setting	TUNER/AMP	DEVICE	TV	SAT/CBL
ON/SOURCE	Power on / Standby			
	Play*			
	Pause*			
	Stop*			
	Manual search* (fast-reverse / fast-forward)			
CHANNEL + -	Switch channels (+, -)			
	Cursor operation			
ENTER	Enter setting			
MENU	Guide menus			
SETUP	Setup			
RETURN	Return			
Default setting (Preset code)	Satellite Receiver		Cable TV	
	Direc TV (095)		-	
Special Remarks	①			

*: When the punch through function (page 48) is set, this functions as the button for the device for which punch through is set.

Assigning buttons that are Not Used to Operate Other Devices (Punch Through Function)

When the remote control unit's device mode is set to "TV" or "SAT/CBL", the next "TUNER", "DVD", "HDP", "iPod", "DVR" or "VCR" operation can be performed without switching the remote control unit's device mode.

- One device each can be assigned to the "TV" and "SAT/CBL" device modes.
- Assignable buttons

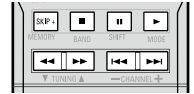

Cautions during operation

When registering a punch through function, point the remote control transmitter toward the AVR-590. The status of the registration operation is displayed on the AVR-590.

1 Press or for the device for which the punch through function is to be registered and simultaneously for over 2 seconds. "RC SETUP START" appears on the display.

2 Press the source select button for the device to be assigned. When registration is completed, "RC SETUP OK" appears on the display.

※ If the codes could not be registered, "RC SETUP NG" appears on the display. Try again.

NOTE

If the "TV" or "SAT/CBL" preset code is changed after setting the punch through function, the punch through setting is canceled.

Other Information

Surround

The AVR-590 is equipped with a digital signal processing circuit that lets you play program sources in the surround mode to achieve the same sense of presence as in a movie theater.

Dolby Surround

Dolby Digital

Dolby Digital is a multichannel digital signal format developed by Dolby Laboratories.

A total of 5.1-channels are played: 3 front channels ("FL", "FR" and "C"), 2 surround channels ("SL" and "SR") and the "LFE" channel for low frequencies.

Because of this, there is no crosstalk between channels and a realistic sound field with a "three-dimensional" feeling (sense of distance, movement and positioning) is achieved.

A real, overpowering sense of presence is achieved when playing movie sources in AV rooms as well.

Dolby Digital Plus

Dolby Digital Plus is an improved Dolby Digital signal format that is compatible with up to 7.1-channels of discrete digital sound and also improves sound quality thanks to extra data bit rate performance. It is upwardly compatible with conventional Dolby Digital, so it offers greater flexibility in response to the source signal and the conditions of the playback equipment.

Dolby TrueHD

Dolby TrueHD is a high definition audio technology developed by Dolby Laboratories, using lossless coding technology to faithfully reproduce the sound of the studio master.

This format is compatible with a maximum sampling frequency of 96 kHz and up to 7.1-channels, so it is used for applications particularly prioritizing sound quality.

Dolby Pro Logic II

Dolby Pro Logic II is a matrix decoding technology developed by Dolby Laboratories.

Regular music such as that on CDs is encoded into 5-channels to achieve an excellent surround effect.

The surround channel signals are converted into stereo and full band signals (with a frequency response of 20 Hz to 20 kHz or greater) to create a "three-dimensional" sound image offering a rich sense of presence for all stereo sources.

Dolby Pro Logic IIx

Dolby Pro Logic IIx is a further improved version of the Dolby Pro Logic II matrix decoding technology.

Audio signals recorded in 2-channels are decoded to achieve a natural sound with up to 7.1-channels.

There are 3 modes: "Music" suited for playing music, "Cinema" suited for playing movies, and "Game" which is optimized for playing games.

Dolby Digital EX

Dolby Digital EX is a 6.1-channel surround format proposed by Dolby Laboratories that allows users to enjoy in their homes the "DOLBY DIGITAL SURROUND EX" audio format jointly developed by Dolby Laboratories and Lucas Films.

The 6.1 channels of sound, including surround back channels, provide improved sound positioning and expression of space.

Dolby Pro Logic IIz

Dolby Pro Logic IIz introduces a new dimension to Home Entertainment through the addition of a pair of front height channels. Compatible with stereo, 5.1 and 7.1 content, Dolby Pro Logic IIz provides enhanced spaciousness, depth and dimension to movies, concert video and videogame playback while maintaining the full integrity of the source mix.

Dolby Pro Logic IIz identifies and decodes spatial cues that occur naturally in all content, directing this information to the front height channels, complementing the performance of left and right surround sound speakers. Content that is encoded with Dolby Pro Logic IIz height channel information can be even more revealing, with perceptually discrete height channel information bringing an exciting new dimension to home entertainment. Dolby Pro Logic IIz, with front height channels is also an ideal alternative for households that cannot support the placement of back surround speakers of a typical 7.1 channel system but may have bookshelf space available to support the addition of height speakers.

Manufactured under license from Dolby Laboratories. "Dolby", "Pro Logic" and the double-D symbol are trademarks of Dolby Laboratories.

DTS Surround

DTS Digital Surround

DTS Digital Surround is the standard digital surround format of DTS, Inc., compatible with a sampling frequency of 44.1 or 48 kHz and up to 5.1-channels of digital discrete surround sound.

DTS-HD High Resolution Audio

DTS-HD High Resolution Audio is an improved version of the conventional DTS, DTS-ES and DTS 96/24 signals formats, compatible with sampling frequencies of 96 or 48 kHz and up to 7.1-channels of discrete digital sound. High data bit rate performance provides high quality sound. This format is fully compatible with conventional products, including conventional DTS digital surround 5.1-channel data.

DTS-HD Master Audio

DTS-HD Master Audio is DTS, Inc's lossless audio format compatible with up to 96 kHz/7.1-channels. The lossless audio coding technology faithfully reproduces the sound of the studio master. It is fully compatible with conventional products, including conventional DTS digital surround 5.1-channel data.

DTS-ES™ Discrete 6.1

DTS-ES™ Discrete 6.1 is a 6.1-channel discrete digital audio format adding a surround back (SB) channel to the DTS digital surround sound. Decoding of conventional 5.1-channel audio signals is also possible according to the decoder.

DTS-ES™ Matrix 6.1

DTS-ES™ Matrix 6.1 is a 6.1-channel discrete digital audio format inserting a surround back (SB) channel to the DTS digital surround sound through matrix encoding. Decoding of conventional 5.1-channel audio signals is also possible according to the decoder.

DTS NEO:6™ Surround

DTS NEO:6™ is a matrix decoding technology for achieving 6.1-channel surround playback with 2-channel sources. It includes "DTS NEO:6 Cinema" suited for playing movies and "DTS NEO:6 Music" suited for playing music.

DTS 96/24

DTS 96/24 is a digital audio format enabling high sound quality playback in 5.1-channels with a sampling frequency of 96 kHz and 24 bit quantization on DVD-Video.

Manufactured under license under U.S. Patent #'s: 5,451,942; 5,956,674; 5,974,380; 5,978,762; 6,226,616; 6,487,535; 7,212,872; 7,333,929; 7,392,195; 7,272,567 & other U.S. and worldwide patents issued & pending. DTS is a registered trademark and the DTS logos, Symbol, DTS-HD and DTS-HD Master Audio are trademarks of DTS, Inc.© 1996-2008 DTS, Inc. All Rights Reserved.

Audyssey

Audyssey MultEQ®

Audyssey MultEQ is a room equalization solution that calibrates any audio system so that it can achieve optimum performance for every listener in a large listening area. Based on several room measurements, MultEQ calculates an equalization solution that corrects for both time and frequency response problems in the listening area and also performs a fully automated surround system setup.

Audyssey Dynamic EQ™

Audyssey Dynamic EQ solves the problem of deteriorating sound quality as volume is decreased by taking into account human perception and room acoustics. Audyssey Dynamic EQ works in tandem with Audyssey MultEQ to provide well-balanced sound for every listener at any volume level.

Audyssey Dynamic Volume™

Audyssey Dynamic Volume solves the problem of large variations in volume level between television programs, commercials, and between the soft and loud passages of movies.

Audyssey Dynamic EQ is integrated into Dynamic Volume so that as the playback volume is adjusted automatically, the perceived bass response, tonal balance, surround impression, and dialog clarity remain the same.



Manufactured under license from Audyssey Laboratories. U.S. and foreign patents pending. Audyssey MultEQ® is a registered trademark of Audyssey Laboratories. Audyssey Dynamic EQ™ is a trademark of Audyssey Laboratories. Audyssey Dynamic Volume™ is a trademark of Audyssey Laboratories.

Surround Modes and Parameters

Surround mode	Signals and adjustability in the different modes																
	Channel output						Parameter (default values are shown in parentheses)										
	Front L/R	Center	Surround L/R	Surround Back L/R	Front Height L/R	Subwoofer	D. Comp * ₁	LFE * ₂	AFDM * ₁	SB CH Out	Cinema EQ.	Mode	Room Size	Effect	Delay time	Subwoofer	DRC * ₃
DIRECT	○	⊙	⊙	⊙	×	⊙	○ (OFF)	○ (0dB)	×	×	×	×	×	×	×	○	○ (Auto)
MULTI CH DIRECT	○	⊙	⊙	⊙	×	⊙	×	○ (0dB)	○ (ON)	○	×	×	×	×	×	×	×
STEREO	○	×	×	×	×	⊙	○ (OFF)	○ (0dB)	×	×	×	×	×	×	×	×	○ (Auto)
MULTI CH IN	○	⊙	⊙	⊙	×	⊙	×	○ (0dB)	○ (ON)	○	×	×	×	×	×	×	×
DOLBY PRO LOGIC IIx	○	⊙	⊙	⊙	×	⊙	○ (OFF)	×	×	○	○ (NOTE1)	○ (Cinema)	×	×	×	×	○ (Auto)
DOLBY PRO LOGIC II	○	⊙	⊙	×	×	⊙	○ (OFF)	×	×	○	○ (NOTE2)	○ (Cinema)	×	×	×	×	○ (Auto)
DTS NEO:6	○	⊙	⊙	⊙	×	⊙	○ (OFF)	×	×	○	○ (NOTE1)	○ (Cinema)	×	×	×	×	×
DOLBY PRO LOGIC IIz	○	⊙	⊙	×	⊙	⊙	○ (OFF)	×	×	×	○ (OFF)	×	×	×	×	×	×
DOLBY DIGITAL	○	⊙	⊙	⊙	⊙	⊙	○ (OFF)	○ (0dB)	○ (ON)	○	○ (OFF)	×	×	×	×	×	×
DOLBY DIGITAL Plus	○	⊙	⊙	⊙	⊙	⊙	○ (OFF)	○ (0dB)	○ (ON)	○	○ (OFF)	×	×	×	×	×	×
DOLBY TrueHD	○	⊙	⊙	⊙	⊙	⊙	○ (OFF)	○ (0dB)	○ (ON)	○	○ (OFF)	×	×	×	×	×	○ (Auto)
DTS SURROUND	○	⊙	⊙	⊙	⊙	⊙	○ (OFF)	○ (0dB)	○ (ON)	○	○ (OFF)	×	×	×	×	×	×
DTS 96/24	○	⊙	⊙	⊙	⊙	⊙	○ (OFF)	○ (0dB)	○ (ON)	○	○ (OFF)	×	×	×	×	×	×
DTS-HD	○	⊙	⊙	⊙	⊙	⊙	○ (OFF)	○ (0dB)	○ (ON)	○	○ (OFF)	×	×	×	×	×	×
5CH/7CH STEREO	○	⊙	⊙	⊙	⊙	⊙	○ (OFF)	○ (0dB)	×	○	×	×	×	×	×	×	×
ROCK ARENA	○	⊙	⊙	⊙	⊙	⊙	○ (OFF)	○ (0dB)	×	○	×	×	○ (Medium)	○ (10)	×	×	×
JAZZ CLUB	○	⊙	⊙	⊙	⊙	⊙	○ (OFF)	○ (0dB)	×	○	×	×	○ (Medium)	○ (10)	×	×	×
MONO MOVIE	○	⊙	⊙	⊙	⊙	⊙	○ (OFF)	○ (0dB)	×	○	×	×	○ (Medium)	○ (10)	×	×	×
VIDEO GAME	○	⊙	⊙	⊙	⊙	⊙	○ (OFF)	○ (0dB)	×	○	×	×	○ (Medium)	○ (10)	×	×	×
MATRIX	○	⊙	⊙	⊙	⊙	⊙	○ (OFF)	○ (0dB)	×	○	×	×	×	×	○ (30 ms)	×	×
VIRTUAL	○	×	×	×	×	⊙	○ (OFF)	○ (0dB)	×	×	×	×	×	×	×	×	×

○ : Signal / Adjustable
 × : No signal / Not adjustable
 ⊙ : Turned on or off by speaker configuration setting

○ : Signal / Adjustable
 × : No signal / Not adjustable
 NOTE1 : This parameter is available when the menu "Mode" (page 39) is set to "Cinema".
 NOTE2 : This parameter is available when the menu "Mode" (page 39) is set to "Cinema" or "PL".

NOTE:
 *1 : When playing Dolby Digital and DTS signals.
 *2 : When playing Dolby Digital, DTS and Linear PCM (multi ch).
 *3 : When playing Dolby TrueHD signal.

Surround mode	Signals and adjustability in the different modes								
	Parameter (default values are shown in parentheses)								
	PRO LOGIC II/IIx MUSIC mode only			NEO:6 MUSIC mode only	Tone (NOTE4)	MultEQ	Dynamic EQ (NOTE5)	Dynamic Volume (NOTE6)	RESTORER (NOTE7)
	Panorama	Dimension	C. Width	Center Image					
DIRECT	×	×	×	×	×	×	×	×	×
MULTI CH DIRECT	×	×	×	×	×	×	×	×	×
STEREO	×	×	×	×	○ (0dB)	○ (OFF)	○ (OFF)	○ (OFF)	○
MULTI CH IN	×	×	×	×	○ (0dB)	○ (OFF)	○ (OFF)	○ (OFF)	×
DOLBY PRO LOGIC IIx	○ (OFF)	○ (3)	○ (3)	×	○ (0dB)	○ (OFF)	○ (OFF)	○ (OFF)	○
DOLBY PRO LOGIC II	○ (OFF)	○ (3)	○ (3)	×	○ (0dB)	○ (OFF)	○ (OFF)	○ (OFF)	○
DTS NEO:6	×	×	×	○ (0.3)	○ (0dB)	○ (OFF)	○ (OFF)	○ (OFF)	○
DOLBY PRO LOGIC IIz	×	×	×	×	○ (0dB)	○ (OFF)	○ (OFF)	○ (OFF)	×
DOLBY DIGITAL	×	×	×	×	○ (0dB)	○ (OFF)	○ (OFF)	○ (OFF)	×
DOLBY DIGITAL Plus	×	×	×	×	○ (0dB)	○ (OFF)	○ (OFF)	○ (OFF)	×
DOLBY TrueHD	×	×	×	×	○ (0dB)	○ (OFF)	○ (OFF)	○ (OFF)	×
DTS SURROUND	×	×	×	×	○ (0dB)	○ (OFF)	○ (OFF)	○ (OFF)	×
DTS-96/24	×	×	×	×	○ (0dB)	○ (OFF)	○ (OFF)	○ (OFF)	×
DTS-HD	×	×	×	×	○ (0dB)	○ (OFF)	○ (OFF)	○ (OFF)	×
5CH/7CH STEREO	×	×	×	×	○ (0dB)	○ (OFF)	○ (OFF)	○ (OFF)	○
ROCK ARENA	×	×	×	×	○ (NOTE3)	○ (OFF)	○ (OFF)	○ (OFF)	○
JAZZ CLUB	×	×	×	×	○ (0dB)	○ (OFF)	○ (OFF)	○ (OFF)	○
MONO MOVIE	×	×	×	×	○ (0dB)	○ (OFF)	○ (OFF)	○ (OFF)	○
VIDEO GAME	×	×	×	×	○ (0dB)	○ (OFF)	○ (OFF)	○ (OFF)	○
MATRIX	×	×	×	×	○ (0dB)	○ (OFF)	○ (OFF)	○ (OFF)	○
VIRTUAL	×	×	×	×	○ (0dB)	○ (OFF)	○ (OFF)	○ (OFF)	○

○ : Adjustable

× : Not adjustable

NOTE3 : BASS +6 dB, TREBLE +4 dB

NOTE4 : Cannot be set when the "Dynamic EQ" (page 42) setting is "ON".

NOTE5 : Cannot be set when the "MultEQ" (page 41) setting is "OFF".

NOTE6 : Cannot be set when the "Dynamic EQ" (page 42) setting is "OFF".

NOTE7 : "RESTORER" can be set for analog or PCM 48 k or 44.1 k input signals.

Differences in Surround Mode Names Depending on the Input Signals

Button	Surround mode	Note	Input signals														
			ANALOG	PCM		DTS-HD		DTS				DOLBY		DOLBY DIGITAL			
			Linear PCM (multi ch)	Linear PCM (2ch)	DTS-HD Master Audio	DTS-HD High Resolution Audio	DTS ES DSCRT (With Flag)	DTS ES MTRX (With Flag)	DTS (5.1ch)	DTS 96/24	DOLBY TrueHD	DOLBY DIGITAL Plus	DOLBY DIGITAL EX (With Flag)	DOLBY DIGITAL EX (With no Flag)	DOLBY DIGITAL (5.1/5/4ch)	DOLBY DIGITAL (4/3ch)	DOLBY DIGITAL (2ch)
STANDARD																	
DTS SURROUND																	
	DTS-HD MSTR		×	×	×	●	×	×	×	×	×	×	×	×	×	×	×
	DTS-HD HI RES		×	×	×	×	●	×	×	×	×	×	×	×	×	×	×
	DTS ES DSCRT6.1	*1 *3	×	×	×	×	×	●◎	×	×	×	×	×	×	×	×	×
	DTS ES MTRX6.1	*1 *3	×	×	×	×	×	●◎	×	×	×	×	×	×	×	×	×
	DTS SURROUND		×	×	×	×	×	○	○	●	×	×	×	×	×	×	×
	DTS 96/24		×	×	×	×	×	×	×	●	×	×	×	×	×	×	×
	DTS (-HD) + PLIIx CINEMA	*2 *3	×	×	×	○	○	○	○	○	○	×	×	×	×	×	×
	DTS (-HD) + PLIIx MUSIC	*1 *3	×	×	×	○	○	○	○	○	×	×	×	×	×	×	×
	DTS (-HD) + PLIIz	*1 *4	×	×	×	○	○	○	○	○	×	×	×	×	×	×	×
	DTS (-HD) + NEO:6	*1 *3	×	×	×	○	○	○	○	○	×	×	×	×	×	×	×
	DTS NEO:6 CINEMA		○	×	○	×	×	×	×	×	×	×	×	×	×	×	○
	DTS NEO:6 MUSIC		○	×	○	×	×	×	×	×	×	×	×	×	×	×	○
DOLBY SURROUND																	
	DOLBY TrueHD		×	×	×	×	×	×	×	×	●	×	×	×	×	×	×
	DOLBY DIGITAL+		×	×	×	×	×	×	×	×	×	●	×	×	×	×	×
	DOLBY DIGITAL EX	*1 *3	×	×	×	×	×	×	×	×	×	×	○	○	○	○	×
	DOLBY (D+) (HD) +EX	*1 *3	×	×	×	×	×	×	×	×	○	○	×	×	×	×	×
	DOLBY DIGITAL		×	×	×	×	×	×	×	×	×	×	○	●	●	●	×
	DOLBY (D) (D+) (HD) +PLIIx CINEMA	*2 *3	×	×	×	×	×	×	×	×	○	○	●◎	○	○	○	×
	DOLBY (D) (D+) (HD) +PLIIx MUSIC	*1 *3	×	×	×	×	×	×	×	×	○	○	○	○	○	○	×
	DOLBY (D) (D+) (HD) +PLIIz	*1 *4	×	×	×	×	×	×	×	×	○	○	○	○	○	○	×
	DOLBY PRO LOGIC IIx CINEMA	*3	○	×	○	×	×	×	×	×	×	×	×	×	×	×	○
	DOLBY PRO LOGIC IIx MUSIC	*3	○	×	○	×	×	×	×	×	×	×	×	×	×	×	○
	DOLBY PRO LOGIC IIx GAME	*3	○	×	○	×	×	×	×	×	×	×	×	×	×	×	○
	DOLBY PRO LOGIC IIz	*4	○	×	○	×	×	×	×	×	×	×	×	×	×	×	○
	DOLBY PRO LOGIC II CINEMA		○	×	○	×	×	×	×	×	×	×	×	×	×	×	○
	DOLBY PRO LOGIC II MUSIC		○	×	○	×	×	×	×	×	×	×	×	×	×	×	○
	DOLBY PRO LOGIC II GAME		○	×	○	×	×	×	×	×	×	×	×	×	×	×	○
	DOLBY PRO LOGIC		○	×	○	×	×	×	×	×	×	×	×	×	×	×	○

NOTE:

- *1: This mode is not available when the surround back speaker setup is set to "None".
- *2: This mode is not available when the surround back speaker setup is set to "1ch" or "None".
- *3: Can be set when "Pre Assign" is set to "Normal".
- *4: Not selectable when "Pre Assign" is set to anything other than "Front Height".

- : Mode selectable in initial status
- ◎ : Mode fixed when "AFDM" is "ON"
- : Selectable mode
- × : Non-selectable mode

Button	Surround mode	Note	Input signals															
			ANALOG	PCM		DTS-HD		DTS				DOLBY		DOLBY DIGITAL				
				Linear PCM (multi ch)	Linear PCM (2ch)	DTS-HD Master Audio	DTS-HD High Resolution Audio	DTS ES DSCRT (With Flag)	DTS ES MTRX (With Flag)	DTS (5.1ch)	DTS 96/24	DOLBY TrueHD	DOLBY DIGITAL Plus	DOLBY DIGITAL EX (With Flag)	DOLBY DIGITAL EX (With no Flag)	DOLBY DIGITAL (5.1/5/4ch)	DOLBY DIGITAL (4/3ch)	DOLBY DIGITAL (2ch)
STANDARD																		
MULTI CH IN																		
	MULTI CH IN		×	●	×	×	×	×	×	×	×	×	×	×	×	×	×	×
	MULTI IN + PLIIx CINEMA	*2 *3	×	○	×	×	×	×	×	×	×	×	×	×	×	×	×	×
	MULTI IN + PLIIx MUSIC	*1 *3	×	○	×	×	×	×	×	×	×	×	×	×	×	×	×	×
	MULTI IN + PLIIz	*1 *5	×	○	×	×	×	×	×	×	×	×	×	×	×	×	×	×
	MULTI IN + Dolby EX	*1 *3	×	○	×	×	×	×	×	×	×	×	×	×	×	×	×	×
	MULTI CH IN 7.1	*3	×	● ◎ (7.1)	×	×	×	×	×	×	×	×	×	×	×	×	×	×
DIRECT																		
	DIRECT		○	×	○	○	○	○	○	○	○	○	○	○	○	○	○	○
	MULTI CH DIRECT		×	○	×	×	×	×	×	×	×	×	×	×	×	×	×	×
	M DIRECT + PLIIx CINEMA	*2 *3	×	○	×	×	×	×	×	×	×	×	×	×	×	×	×	×
	M DIRECT + PLIIx MUSIC	*1 *3	×	○	×	×	×	×	×	×	×	×	×	×	×	×	×	×
	M DIRECT + PLIIz	*1 *5	×	○	×	×	×	×	×	×	×	×	×	×	×	×	×	×
	M DIRECT + Dolby EX	*1 *3	×	○	×	×	×	×	×	×	×	×	×	×	×	×	×	×
	M DIRECT 7.1	*3	×	○ (7.1)	×	×	×	×	×	×	×	×	×	×	×	×	×	×
DSP SIMULATION																		
	5CH/7CH STEREO	*4	○	○	○	○	○	○	○	○	○	○	○	○	○	○	○	○
	ROCK ARENA		○	○	○	○	○	○	○	○	○	○	○	○	○	○	○	○
	JAZZ CLUB		○	○	○	○	○	○	○	○	○	○	○	○	○	○	○	○
	MONO MOVIE		○	○	○	○	○	○	○	○	○	○	○	○	○	○	○	○
	VIDEO GAME		○	○	○	○	○	○	○	○	○	○	○	○	○	○	○	○
	MATRIX		○	○	○	○	○	○	○	○	○	○	○	○	○	○	○	○
	VIRTUAL		○	○	○	○	○	○	○	○	○	○	○	○	○	○	○	○
STEREO																		
	STEREO		●	○	●	○	○	○	○	○	○	○	○	○	○	○	○	○

NOTE :

- *1: This mode is not available when the surround back speaker setup is set to "None".
- *2: This mode is not available when the surround back speaker setup is set to "1ch" or "None".
- *3: Can be set when "Pre Assign" is set to "Normal".
- *4: If the surround back speaker setup is set to "None", then "5CH STEREO" is displayed.
- *5: Not selectable when "Pre Assign" is set to anything other than "Front Height".

- : Mode selectable in initial status
- ◎ : Mode fixed when "AFDM" is "ON"
- : Selectable mode
- × : Non-selectable mode

Troubleshooting

If a problem should arise, first check the following:

1. Are the connections correct?
2. Is the set being operated as described in the owner's manual?
3. Are the other components operating properly?

If this unit does not operate properly, check the items listed in the table below. Should the problem persist, there may be a malfunction.

In this case, disconnect the power immediately and contact your store of purchase.

[General]

Symptom	Cause	Countermeasure	Page
Set does not operate properly.	<ul style="list-style-type: none"> External noise or interference is causing the set to malfunction. 	<ul style="list-style-type: none"> Reset the microprocessor. 	57
Power does not turn on, or turns off directly after it was turned on.	<ul style="list-style-type: none"> Connection of the power cord is faulty. 	<ul style="list-style-type: none"> Check the insertion of the power cord plug. 	16
No sound is produced from speakers.	<ul style="list-style-type: none"> Connection with the input devices or connection of the speaker cables is faulty. 	<ul style="list-style-type: none"> Check the connections. 	11
	<ul style="list-style-type: none"> Device you want to play and set input source do not match. 	<ul style="list-style-type: none"> Select an appropriate input source. 	34
	<ul style="list-style-type: none"> Master volume is turned too low. 	<ul style="list-style-type: none"> Adjust the master volume to an appropriate level. 	34
	<ul style="list-style-type: none"> Mute mode is set. 	<ul style="list-style-type: none"> Cancel the mute mode. 	37
	<ul style="list-style-type: none"> Headphones are connected. 	<ul style="list-style-type: none"> Disconnect the headphones. 	37
No digital signals are being input.	<ul style="list-style-type: none"> No digital signals are being input. 	<ul style="list-style-type: none"> Select an input source for which the digital input setting has been made. 	31
	<ul style="list-style-type: none"> The connectors to which the digital inputs are assigned and the settable input modes do not match. 	<ul style="list-style-type: none"> Set the input mode. 	32
Display is off.	<ul style="list-style-type: none"> The "Display" setting is set to "OFF". 	<ul style="list-style-type: none"> Set to something other than "OFF". 	37
"DOLBY DIGITAL" indicator does not appear on display.	<ul style="list-style-type: none"> Blu-ray Disc player / DVD player's digital audio output setting is not proper. 	<ul style="list-style-type: none"> Check the Blu-ray Disc player / DVD player's audio output setting. For details, read the Blu-ray Disc player / DVD player's operating instructions. 	–

Symptom	Cause	Countermeasure	Page
Power switches off suddenly while you are using the AVR-590, the power indicator will flash in red at intervals of approximately 2 seconds.	<ul style="list-style-type: none"> The protection circuit will be activated depending upon the temperature rise in the internal parts of the unit. 	<ul style="list-style-type: none"> Please switch off power at once, and re-apply the power after the body temperature has fallen sufficiently. Please re-install AVR-590 in a place having good ventilation. 	3 –
Power switches off suddenly while you are using the AVR-590, the power indicator will flash red at intervals of approximately 0.5 seconds.	<ul style="list-style-type: none"> Use speakers having impedance less than that specified. If speaker cable core wires touch each other or the core wires become disconnected from their terminals, the protection circuit will be activated in the event of core wires coming into contact with the AVR-590 rear panel. 	<ul style="list-style-type: none"> Please use speakers which have the specified impedance. Unplug the power cord, then after twisting the core wires together tightly again, or effecting termination treatments etc, please reconnect once again. 	12 12
			–
Even applying power, the power display flashes red at intervals of approximately 0.5 seconds.	<ul style="list-style-type: none"> The AVR-590 amplifier circuit has failed. 	<ul style="list-style-type: none"> Switch off the power and please contact the DENON service adviser. 	–
Set does not work properly when remote control unit operated.	<ul style="list-style-type: none"> Batteries are worn. You are operating outside of the specified range. Obstacle between main unit and remote control unit. The batteries are not inserted in the proper direction, as indicated by the polarity marks in the battery compartment. The set's remote control sensor is exposed to strong light (direct sunlight, inverter type fluorescent bulb light, etc.). The device selection switch is not set to the proper position. 	<ul style="list-style-type: none"> Replace with new batteries. Operate within the specified range. Remove the obstacle. Insert the batteries in the proper direction, following the polarity marks in the battery compartment. Move the set to a place in which the remote control sensor will not be exposed to strong light. Set the device selection switch to the proper position, according to the purpose for operating the switch. Before operating the remote control unit, set the device mode for the device to be operated. 	3 3 3 3 3
			46
			46
			46
			46

[Audio]

Symptom	Cause	Countermeasure	Page
No sound is produced from center speaker.	• You are playing a monaural source (TV, etc.) in the "STANDARD" (Dolby/DTS Surround) mode.	• The mode is set to something other than "STANDARD" (Dolby/DTS Surround).	37
No sound is produced from surround speakers.	• The surround mode is set to "STEREO"; or "DIRECT".	• Set to a surround playback mode.	38, 39
No sound is produced from surround back speaker.	• The pre-out assignment for the surround back speakers is not set.	• Set the pre-out assignment to the surround back speakers.	24
	• "S.Back" setting is set to "None".	• Set to something other than "None".	25
	• The "Parameter" – "Surround Parameter" – "SB CH Out" settings are "OFF".	• Please set "Parameter" – "Surround Parameter" – "SB CH Out" to settings other than "OFF".	39
	• Surround mode not set to a mode for 6.1- or 7.1-channel playback.	• Select a surround playback mode.	37
No sound is produced from subwoofer.	• Subwoofer's power not turned on.	• Turn on the subwoofer's power.	–
	• The "Subwoofer" setting at "Speaker Config." is set to "No".	• Set to "Yes".	24
	• The subwoofer is not properly connected.	• Check the connections.	11
The subwoofer's volume is turned off.	• The subwoofer's volume is turned off.	• Adjust the subwoofer's volume to an appropriate level.	45
		–	–
DTS sound is not output.	• Blu-ray Disc player / DVD player's audio output setting is not set to bitstream.	• Set the Blu-ray Disc player / DVD player. For details, refer to the Blu-ray Disc player / DVD player's operating instructions.	–
	• Blu-ray Disc player / DVD player is not compatible with DTS sound playback.	• Use a DTS-compatible player.	–
	• The AVR-590's "Decode Mode" setting is set to "PCM".	• Set to the "Auto" or "DTS" mode.	32
HDMI audio signals are not output from speakers.	• The "Manual Setup" – "HDMI Setup" – "HDMI Audio Out" setting is set to "TV".	• Set to "AMP".	27
No sound is output from the monitor connected with HDMI connections.	• The "Manual Setup" – "HDMI Setup" – "HDMI Audio Out" setting is set to "AMP".	• Set to "TV".	27

Symptom	Cause	Countermeasure	Page
Dolby TrueHD, DTS-HD, Dolby Digital Plus audio is not output.	• HDMI is not connected.	• Connect the HDMI.	13
	• Blu-ray Disc player's audio output setting is not set to bitstream.	• Set the Blu-ray Disc player. For details, refer to the Blu-ray Disc player's operating instructions.	–
	• Blu-ray Disc player is not compatible with DTS sound playback.	• Use a DTS-compatible player.	–

[Video]

Symptom	Cause	Countermeasure	Page
No picture appears.	• The connections between the AVR-590 and monitor are faulty.	• Check the connections.	13 ~ 16
	• The monitor's input setting is wrong.	• Set properly.	–
	• The player is connected using the component input connectors, the monitor is connected using the video (yellow) output connectors.	• High definition (1080i/720p) and progressive (480p/576p) video signals are not down-converted. Set the player to interlace (480i/576i) signals.	–
Picture cannot be recorded.	• Input source does not match recorder's video connection connector (video).	• The video conversion function does not work for the REC OUT connectors. Match the input source and recorder connections.	15
DVDs cannot be copied on a DVR.	–	• This is not a malfunction. Most movie software includes copy prevention signals and cannot be copied.	–
The menu screen and status indicators are not displayed.		• When viewing HDMI or component video signals via the AVR-590, the on-screen display appears when the MENU button on the main unit or the MENU button on the main remote control unit.	9
	• "OFF" is displayed for the status.	• Set "Manual Setup" – "Option Setup" – "On-Screen Display" – "Text" to "ON".	28
	• The main volume display is "OFF".	• Set "Manual Setup" – "Option Setup" – "On-Screen Display" – "Master Volume" to "Top" or "Bottom".	28
	• The display during tuner operation is "OFF".	• Set when "Manual Setup" – "On-Screen Display" – "Tuner Information" is not "OFF".	29
	• The display during iPod operation is "OFF".	• Set when "Manual Setup" – "On-Screen Display" – "iPod Information" is not "OFF".	29

[HDMI]





Symptom	Cause	Countermeasure	Page
HDMI audio signals are not output from speakers.	<ul style="list-style-type: none"> The "Manual Setup" – "HDMI Setup" – "HDMI Audio Out" setting is set to "TV" 	<ul style="list-style-type: none"> Set to "Amp" 	27
No picture appears with HDMI connections.	<ul style="list-style-type: none"> The connections to the HDMI connectors are faulty. HDMI input setting is improper. The monitor is not compatible with copyright protection (HDCP). The HDMI format of the player and monitor do not match. 	<ul style="list-style-type: none"> Check the connections. Check the HDMI input setting. Connect a monitor that is compatible with copyright protection (HDCP). Match the HDMI format of the player and monitor. 	13 31 12
No sound is output from the monitor connected with HDMI connections.	<ul style="list-style-type: none"> The "Manual Setup" – "HDMI Setup" – "HDMI Audio Out" setting is set to "Amp." 	<ul style="list-style-type: none"> Set to "TV". 	27
When performing the following operations on a connected device, AVR-590 has the same operations. · Power ON/OFF · Switching audio output devices · Adjust volume · Switch input source	<ul style="list-style-type: none"> HDMI's CEC function is operating. 	<ul style="list-style-type: none"> Set "Manual Setup" – "HDMI Setup" – "HDMI Control" to "OFF". When you only want to operate the power on/off each device, set "Power Off Control" to "OFF". 	27

[iPod]

Symptom	Cause	Countermeasure	Page
iPod cannot be played.	<ul style="list-style-type: none"> The input source assigned to "iPod Dock" is not selected. Cable is not properly connected. Control dock for iPod's AC adapter is not connected to power outlet. 	<ul style="list-style-type: none"> Switch to the input source assigned at "iPod Dock". Reconnect. Plug the control dock for iPod's AC adapter into a power outlet. 	31 14 –

Restoring all the settings to as they were at the time of purchase (Resetting the Microprocessor)

Perform this procedure if the display is abnormal or if operations cannot be performed.
When the microprocessor is reset, all the settings are reset to their default values.

- Turn off the power using  on the main unit.
- Press  while simultaneously pressing  and  on the main unit.
- Once the display starts flashing at intervals of about 1 second, release the two buttons.

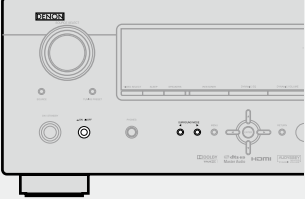

If in step 3 the display does not flash at intervals of about 1 second, start over from step 1.

Specifications

Audio section

Power amplifier

Rated output:

Front :

75 W+75 W (8 Ω/ohms, 20 Hz ~ 20 kHz with 0.08 % T.H.D.)
110 W+110 W (6 Ω/ohms, 1 kHz with 0.7 % T.H.D.)

Center:

75 W (8 Ω/ohms, 20 Hz ~ 20 kHz with 0.08 % T.H.D.)
110 W (6 Ω/ohms, 1 kHz with 0.7 % T.H.D.)

Surround:

75 W+75 W (8 Ω/ohms, 20 Hz ~ 20 kHz with 0.08 % T.H.D.)
110 W+110 W (6 Ω/ohms, 1 kHz with 0.7 % T.H.D.)

Output connectors:

Front, Center, Surround :

6~16 Ω/ohms

Analog

Input sensitivity / Input impedance:

200 mV / 47 kΩ/kohms

Frequency response:

10 Hz ~ 100 kHz — +1, -3 dB (DIRECT mode)

S/N:

98 dB (IHF-A weighted, DIRECT mode)

Video section

Standard video connectors

Input / output level and impedance:

1 Vp-p, 75 Ω/ohms

Frequency response:

5 Hz ~ 10 MHz — +1, -3 dB

Color component video connector

Input / output level and impedance:

Y (brightness) signal — 1 Vp-p, 75 Ω/ohms

P_B / C_B signal — 0.7 Vp-p, 75 Ω/ohms

P_R / C_R signal — 0.7 Vp-p, 75 Ω/ohms

Frequency response:

5 Hz ~ 60 MHz — +0, -3 dB

Tuner section

[FM]

[AM]

(note: μV at 75 Ω/ohms, 0 dBf = 1 x 10⁻¹⁵ W)

Receiving Range:

87.5 MHz ~ 107.9 MHz

520 kHz ~ 1710 kHz

Usable Sensitivity:

1.2 μV (12.8 dBf)

18 μV

50 dB Quieting Sensitivity:

MONO 2.8 μV (20.2 dBf)

STEREO 48.7 μV (45.0 dBf)

S/N (IHF-A):

MONO 70 dB

STEREO 67 dB

Total harmonic Distortion (at 1 kHz):

MONO 0.7 %

STEREO 1.0 %

General

Power supply:

AC 120 V, 60 Hz

Power consumption:

4.3 A

0.3 W (Standby)

Maximum external dimensions:

434 (W) x 171 (H) x 377 (D) mm (17-3/32" x 6-47/64" x 14-27/32")

Weight:

9.3 kg (20 lbs 8 oz)

Remote control unit (RC-1120)

Batteries:

R03/AAA Type (two batteries)

Maximum external dimensions:

50 (W) x 211 (H) x 22 (D) mm (1-31/32" x 8-5/16" x 55/64")

Weight:

110 g (Approx 3.9 oz) (including batteries)

* For purposes of improvement, specifications and design are subject to change without notice.

DEVICE SELECT : TV

Television

A	A.R. Systems	284
	Accent	276, 284
	Accuscan	224
	Action	188, 268
	Acura	276
	Addison	238
	ADL	349
	Admiral	045, 233, 213, 218, 224, 233, 239, 244, 252
	Advent	219, 242, 280, 287, 288, 293
	Adventura	032
	Adventuri	235
	Agna	182
	Aiko	238, 276, 284, 316
	Aim	241, 284
	Aiwa	172, 216, 264, 380, 400, 413, 414
	Akai	016, 186, 188, 190, 193, 209, 235, 237, 246, 253, 254, 274, 276, 284, 300, 316
	Akashi	276
	Akiba	284
	Akito	284
	Akura	214, 276, 284, 356
	Alaron	319
	Alba	209, 276, 284
	Albatron	186, 248
	Alfide	246
	Alleron	062, 188, 319
	Allstar	284
	All-Tel	249
	A-Mark	218, 224, 276
	Ambassador	182, 320
	America Action	239
	American High	235, 237
	Ampro	261
	Amstrad	214, 235, 276, 272, 284, 320
	Amtron	235, 239
	Anam	006, 036, 177, 186, 239, 276, 284, 299
	Anam National	036, 177, 239, 268, 284
	Anglo	276
	Anhua	213
	Anitech	276, 284
	Ansonic	276, 284
	AOC	048, 133, 184, 188, 193, 233, 235, 237, 238, 239, 276, 299, 319
	Apex Digital	170, 192, 194, 259
	Archer	276

	Asora	276
	Audiovox	276
	Awa	184, 272
	Axion	301, 302
	Axxent	276
B	Baihe	276
	Baile	185, 276
	Baird	284
	Basic Line	276, 284
	Bauer	023
	Baur	284
	Baysonic	239, 240, 252
	Beaumont	188, 193, 244
	Beijing	185, 254, 276, 280, 283
	Beko	284
	Belcor	188, 235
	Bell & Howell	045, 191, 218, 233, 244
	BenQ	198, 205
	Beon	284
	Bestar	284
	Blaupunkt	319
	Blue Sky	221, 284, 291
	Boots	276
	Boxlight	346
	BPL	284
	Bradford	239
	Brinkmann	284
	Brionvega	284
	Brockwood	188, 193, 235
	Broksonic	172, 209, 239, 240, 252, 320, 361
C	Bush	185, 276, 284
	Caihong	276, 280
	Cailing	170
	Candle	030, 032, 050, 188, 193, 235, 319
	Capehart	188, 193, 238, 244
	Capetronic	188
	Carena	284
	Carnivale	188
	Carrefour	284
	Carver	218, 319
	Cascade	276, 284
	Casio	284
	Cathay	284
	CCE	284
	Celebrity	193, 235
	Celera	259
	Celestial	194
	Centurion	284
	Changcheng	185, 213, 276, 280
	Changfei	276, 280

	Changfeng	280
	Changhai	276, 280
	Changhong	192, 194, 201, 259, 276, 280, 287
	Chengdu	276, 280
	Ching Tai	238, 276
	Chun Yun	186, 235, 238, 239, 248, 276
	Chunfeng	276
	Chung Hsin	173, 239
	Chunsun	276, 280
	Cimline	276
	Cinema	246
	Cineral	184, 238
	Circuit City	193
	Citek	224
	Citizen	023, 030, 032, 034, 050, 123, 184, 188, 193, 209, 214, 218, 235, 237, 238, 239, 252, 316, 319
	City	276
	Clarion	239
	Clarivox	284
	Classic	188, 238
	Clatronic	276, 284
	Colortyme	188, 193, 218, 224, 235, 237, 244, 319
	Commercial Solutio	229
	Commercial Solutions	224
	Concerto	193, 235
	Concorde	276
	Condor	276, 284
	Conia	356
	Conic	193
	Conrowa	190, 192, 201, 276
	Contec	013, 023, 041, 239, 276, 284
	Cony	023, 041, 239
	Cosmel	276, 284
	Craig	214, 239
	Crosley	188, 214, 218, 235, 239
	Crown	023, 173, 233, 239, 246, 276, 284
	Crown Mustang	246
	CTX	205
	Curtis Mathes	023, 034, 044, 053, 184, 188, 190, 191, 193, 210, 213, 218, 224, 226, 228, 233, 235, 237, 239, 253, 282, 284, 316, 319
	CXC	239
D	Daenyx	239, 246
	Daewoo	023, 048, 107, 184, 185, 186, 187, 188, 191, 193, 205, 215, 237, 238, 239, 246, 249, 258, 276, 284, 299, 319, 388, 389, 395
	Dansai	276, 284, 316
	Dawa	276, 284

	Daytek	246
	Daytron	188, 193, 238, 239, 276, 284
	Dayu	185
	Decca	284
	Dell	220, 348
	Denon	190, 322
	Denstar	299
	Denver	284, 285
	Desmet	276, 284
	Dewo	299
	Diamant	284
	Diamond	241, 246, 276
	Digatron	284
	Digiline	284
	Digital Life	340
	Digitor	284
	Dimensia	044
	Dixi	027, 222, 276, 284
	DL	285, 340
	Dongda	276
	Donghai	276
	Dream Vision	359
	Drean	284
	DTS	276
	Dual	284
	Dumont	193, 239, 244
	Durabrand	171, 193, 214, 239, 251, 252
	Dux	284
	D-Vision	284
	Dwin	233, 297
	Dynatron	284
E	Eaton	237
	ECE	284
	Elbe	284
	Electroband	193, 235
	Electrograph	215
	Electrohome	023, 036, 058, 182, 188, 191, 193, 235, 240, 252, 274
	Elekta	276
	Elektra	187, 244
	ELG	284
	Elin	276, 284
	Elite	284
	Elta	027, 276
	Emerald	193, 320
	Emerson	023, 060, 062, 123, 124, 148, 172, 173, 182, 184, 191, 193, 214, 239, 224, 244, 251, 284, 239, 240, 252, 258, 319, 320, 362
	Envision	188, 319, 329
	Epson	331, 333
	Erres	284

	ESA	214, 254, 362
	ESC	284
	Ether	188, 276
	Etron	027, 276
	Euroman	284
	Europa	284
	Europhon	284
	Evolution	205
	Exquisit	284
F	Feilang	276
	Feilu	276, 280
	Feiyue	276, 280
	Fenner	276
	Ferguson	173, 209, 284
	Fidelity	214, 284
	Finlux	284
	Firstar	240, 276
	Firstline	276, 284
	Fisher	021, 191, 218, 224, 235
	Flint	284
	Formenti	023, 284
	Fortress	233
	Fraba	284
	Friac	276, 284
	Frontech	276
	Fujimaro	249, 356
	Fujitsu	062, 178, 179, 180, 214, 276
	Fujitsu General	178, 276
	Fujitsu Siemens	179
	Funai	062, 214, 216, 235, 239, 396, 397
	Furi	190, 280
	Futuretech	066, 239
G	Galaxi	284
	Galaxis	284
	Ganxin	280
	Gateway	205, 215
	GBC	276
	GE	034, 036, 044, 058, 066, 088, 184, 188, 193, 222, 213, 224, 226, 228, 229, 231, 233, 234, 235, 237, 238, 239, 316
	GEC	284
	Geloso	276
	Gemini	224
	General Electric	224
	General Technic	276
	Genesis	276, 284
	Genexxa	276, 284
	Gericom	249, 349
	Giant	276
	Gibraltar	188, 235, 244
	Go Video	237, 344

Go Vision	301
Goldstar	023, 048, 133, 188, 191, 193, 213, 222, 224, 240, 275, 276, 284, 290
Goodmans	185, 235, 272, 276, 284, 285, 316
Gradiente	173, 284, 319
Granada	283, 284
Grandin	249, 276, 284
Grundig	178, 209, 241, 246, 285
Grundy	062, 139
H Haaz	241
Haier	171, 267, 287, 285
Haihong	276
Haiyan	280
Hallmark	193, 239, 240
Hankook	188, 193, 239, 299
Hanseatic	185, 276, 284
Hantarex	249, 276, 284
Hantor	284
Harley Davidson	188, 193, 216, 235, 237, 239
Harman/Kardon	218
Harsper	249
Harvard	239
Harwood	276, 284
Hauppauge	284
Havermy	233
HCM	276, 284
Heathkit	244
Helios	249
Hello Kitty	184
Hema	276
Highline	184
Himitsu	239, 299
Hinari	276, 284
Hisense	170, 190, 192, 201, 276, 291
Hitachi	023, 041, 070, 124, 182, 188, 190, 192, 193, 199, 201, 202, 208, 213, 216, 218, 224, 235, 238, 244, 274, 284, 316, 376, 384, 385, 386, 394, 408, 409, 410, 412
Hitachi Fujian	182
Hitachi Pay TV	151
Hitsu	276
Hoehner	249
Hongmei	233, 276, 280
Hongyan	280
Hornophon	284
Hua Tun	276
Huafa	190, 276
Huanghaimei	276
Huanghe	276, 280
Huanglong	276
Huangshan	276, 280
Huanyu	280

Huari	190
Hugoson	309, 349
Huodateji	213
Hyper	276
Hypson	284
Hyundai	195, 249
I Iberia	284
ICE	284
Iiyama	309, 349
Ima	193, 239, 240
Imperial	284
Imperial Crown	185, 276
Indiana	284
Infinity	017, 218, 222
Ingersol	276
Inno Hit	276
Innova	284
Innowert	249
Insignia	214
Inteq	190, 244
Interbuy	276, 284
Interfunk	184
Internal	184
Intervision	276, 284
Irradio	276, 284
IRT	184, 187, 299
Isukai	184
ITS	184
ITT Nokia	239
ITV	284
J Janeil	032
JBL	018, 218, 222
JC Penny	034, 041, 044, 048, 050, 058, 066, 088, 094, 192, 193, 237, 275
JCB	193, 235
Jean	192, 213, 238, 240, 276
JEC	316
Jensen	242, 280, 288, 293
Jiahua	213
JiaLiCai	276
JIL	188
Jinfeng	213, 283
Jinque	276, 280
Jinta	276
Jinxing	190, 192, 218, 276, 280, 284
Juhua	280
Jutan	188
JVC	023, 041, 072, 073, 173, 174, 175, 176, 178, 188, 218, 233, 252, 268
K Kaige	276, 280
Kaisui	276, 284
Kamp	239, 244
Kangli	185, 276, 280

Kangyi	276
Kawasho	018, 188, 193
KDS	356
KEC	237, 239
Ken Brown	240, 252
Kendo	284
Kenia	188
Kenwood	188, 193, 239, 240, 319
Khind	241
Kioto	218, 241, 284
KLH	192
KLL	284
Kloss	005, 032, 188
Kloss Novabeam	005, 032, 101
Kneissel	284
Kolin	173, 182, 239, 355
Kolster	284
Kongque	276, 280
Konichi	276
Konig	284
Konka	239, 263, 265, 266, 280, 284, 285, 286, 297, 299
Korpel	284
Kosmos	284
Kost	278
Koyoda	276
KTV	074, 123, 188, 239, 252
Kuaille	276
Kulun	276
Kunlun	185, 213, 280, 283
L L&S Electronic	249
Lark	191
Leader	276
Lecson	284
Legend	276
Lenco	284, 285
Lenoir	276
Leyco	284
LG	188, 193, 186, 196, 218, 237, 276, 284, 290, 348, 351, 360, 387, 394
Liesenk & Tter	284
Liesenkotter	284
Lifetec	178, 276, 284
Lihua	280
Lloyd's	188, 216, 239, 240, 276
Local Chennai TV	276
Local India TV	276
Loewe	222, 284
Logik	045, 237, 239, 240, 349, 272, 276
Longjiang	280
Luma	276
Lumatron	284
Lux May	276, 284

Luxman	193
LXI	017, 034, 044, 075, 103, 188, 191, 192, 193, 210, 213, 214, 218, 222, 224, 233, 235, 237, 244, 284, 316
M M & S	218
M Electronic	185, 276, 284
Madison	284
MAG	356
Magnadyne	218
Magnasonic	235, 188, 218, 238, 233, 192
Magnavox	005, 017, 030, 050, 079, 085, 089, 101, 108, 110, 177, 188, 191, 193, 213, 214, 215, 216, 218, 221, 222, 224, 237, 238, 235, 239, 241, 272, 284, 316, 319, 328, 362
Magnum	284
Majestic	244
Manesth	316, 284
Manhattan	284
Marantz	017, 193, 188, 284, 218, 324, 289, 290, 222
Mark	276, 284
Mastro	173, 241
Masuda	276, 284
Matsui	022, 276, 272, 316, 284, 320
Matsushita	213, 177, 268
Matsuyama	285
Maxent	205, 215
MCE	276
Mediator	284
Medion	284
Megapower	186
Megatron	276, 224, 190, 274, 193
Meile	180
Memorex	027, 045, 276, 188, 316, 284, 237, 182, 191, 193, 239, 177, 252, 172
Memphis	276
Mercury	276, 284, 237
Mermaid	284
Metz	160, 161, 162, 284, 285
MGA	182, 193, 048, 240, 058, 021, 018, 188
MGN Technology	193
Micro Genius	182
Micromaxx	284
Midland	034, 244, 224, 213
Minato	284
Minoka	284
Minutz	066
Mitsubishi	016, 021, 048, 058, 081, 105, 177, 182, 188, 191, 193, 233, 234, 239, 240, 272, 277, 280, 281, 284, 369, 385, 386, 394
Monaco	276
Monivision	186, 248
Montgomery Ward	011, 066, 101, 144, 235

Morgan's	284
Motorola	036, 182, 213, 218, 233
MTC	034, 048, 188, 193, 237, 238, 239, 272
Mudan	276, 213, 283, 280
Multitec	284
Multitech	276, 284, 239
Mx Onda	356
N NAD	075, 192, 193, 201, 210, 211, 212, 284
Naiko	284
Nakimura	284
Nanbao	276
Nansheng	280
NAT	283
National	036, 213, 239, 283
National Quenties	283
NEC	319, 036, 048, 173, 185, 188, 191, 192, 193, 213, 224, 240, 276, 272, 280, 319, 321, 323, 324, 342, 359
Neckermann	284
NEI	284
Neovia	249
Netsat	284
NetTV	215
Neufunk	276, 284
New Tech	276, 284
Newave	276, 238, 233, 193
Nikkai	276, 316, 284
Nikko	188, 238, 193
Nikkodo	188, 238, 193
Nishi	188
Noblex	284, 191
Nokia	239
Norcent	170, 247
Nordmende	284
Normerel	284
Novatronic	284
NTC	238
Nyon	235
O Okano	276, 284
Olevia	347, 350, 355, 358
Omnii	170, 340
Onida	173, 175
Onwa	239
Opera	284
Optimus	211, 188, 233, 182, 191, 210, 193, 239, 177, 268
Optoma	345
Optonica	011, 233
Orbit	284
Orion	214, 272, 244, 284, 320, 193, 239, 240, 252, 251, 172
Orline	284

Osaki	284
Osio	284
Osume	284
Otic	356
Otto Versand	284, 233, 283
Pace	238
Pacific	284, 209
Packard Bell	238, 291
Palladium	284
Palsonic	284, 216
Panama	276, 284
Panasonic	009, 017, 036, 177, 181, 188, 192, 213, 218, 222, 235, 240, 270, 271, 283, 284, 268, 180, 269, 311, 316, 376, 384, 385
Panavision	284
Panda	276, 213, 283, 241, 280
Pausa	276
Paxonic	188, 237
PCE	237, 192
Penney	235, 188, 316, 284, 224, 213, 237, 192, 193, 177, 228
Perdio	284
Perfekt	284
Petters	357
Philco	005, 023, 030, 036, 079, 050, 085, 089, 101, 172, 184, 187, 188, 190, 284, 218, 238, 239, 252, 193, 299
Philips	005, 017, 023, 030, 036, 050, 087, 088, 089, 101, 188, 193, 205, 213, 214, 217, 218, 221, 222, 223, 235, 238, 244, 276, 284, 290
Phoenix	284
Phonola	284
Pilot	272, 288, 213, 237, 193, 241
Pioneer	124, 142, 370, 415, 416, 272, 284, 319, 218, 211, 212, 310
Plantron	276, 284
Playsonic	284
Polaroid	258, 249, 278, 291, 279, 353, 354, 292, 356, 357
Poppy	276
Portland	238, 184
Powerpoint	284
Precision	320, 239, 240
Premier	276
Price Club	237
Prima	276, 242, 287, 288, 280, 293
Princeton	186, 325
Prism	213, 177
Profex	276
Profi	276
Profronic	284
Proline	284
Proscan	034, 044, 224, 282, 228, 229, 231

Proscop	192
Prosonic	284
Protec	276, 284
Protech	276, 284
Proton	185, 023, 092, 276, 188, 193, 282
Proview	356
ProVision	284
Pulsar	149, 244, 238, 193
Pye	284
Pymi	276
Qingdao	213, 283, 280
Quadral	213
Quartz	182, 193
Quasar	036, 213, 074, 276, 316, 177, 268, 249
Quelle	272, 284
Rabbit	224
Radio Shack	011, 044
Radiola	284
Radiomarelli	284
RadioShack	188, 284, 224, 182, 191, 193, 239, 216
Radiotone	276, 284
RCA	034, 044, 130, 151, 152, 185, 188, 189, 193, 211, 222, 213, 218, 224, 225, 226, 227, 228, 229, 230, 231, 232, 233, 235, 237, 238, 234, 302, 312
Realistic	011, 181, 224, 182, 191, 193, 239
Recor	284
Rectiligne	284
Redstar	284
Reflex	284
Relisys	249
Remotec	284, 233, 190, 214, 177
Revox	284
RFT	284
R-Line	284
Roadstar	276, 284
Rowa	276, 284, 285, 176, 280
Runco	244, 288, 237, 321, 323
Ruyi	280
Saba	177
Saige	276, 280
Saisho	027, 276, 272, 320
Saivod	284
Sampo	276, 188, 224, 238, 233, 191, 214, 193, 268, 186, 215, 205, 034, 094, 053, 188, 189, 191, 192, 193, 218, 222, 224, 233, 237, 238, 240, 243, 244, 253, 254, 257, 260, 276, 280, 283, 284, 285, 300, 308, 316, 318, 382, 401
Samsung	
Sanky	188, 237
Sansei	238, 184

Sansui	251, 188, 284, 237, 252, 241, 216, 172, 209
Santon	276
Sanyo	013, 021, 081, 096, 190, 191, 192, 214, 215, 218, 224, 235, 239, 245, 252, 276, 272, 284, 290, 319, 324, 327, 346, 384, 392, 393, 404
Sanyong	284
Sanyuan	276, 233, 280
Saville	237
SBR	222, 284
Sceptre	349
Schneider	222, 284, 216
Scotch	193
Scott	062, 188, 320, 193, 239, 240, 021, 023, 034, 041, 062, 073, 075, 173, 188, 191, 192, 193, 210, 213, 218, 214, 216, 224, 233, 235, 237, 240, 244, 284, 316, 327
Sears	
SEG	276, 284
SEI	284, 320
Sei-Sinudyne	284
Semivox	239, 240, 252
Semp	192, 203
Sencora	276
Sentra	316
Serie Dorada	188, 192, 193, 239
Serino	233
Shancha	280
Shanghai	276, 283, 280
Shaofeng	190, 280
Sharp	011, 013, 026, 099, 104, 173, 188, 218, 233, 234, 239, 268, 372, 373, 276, 294, 295, 296, 297, 298, 398, 402, 403
Shen Ying	276, 238
Shencai	276, 190
Sheng Chia	276, 233, 240
Shenyang	276, 280
Sherwood	276
Shintoshii	284
Shivaki	284, 193
Show	276
Siam	284
Siemens	013, 284, 190
Siera	284
Signature	045, 144, 188, 224, 233
Signet	278
Silva	284
Silva Schneider	284
Silvano	285
Simpson	050, 272, 188, 193
Singer	276, 284, 273, 238
Sinudyne	284, 320
SKY	284

Skygiant	239
Sky-North	284
Skyworth	276, 284, 170, 280
Sliding	249
Soemtron	249
Solar Drape	235
Solavox	284
Sole	329
Songba	276
Soniko	284
Sonneclair	284
Sonoko	276, 284
Sontec	276, 284
Sony	173, 182, 191, 193, 216, 235, 236, 244, 263, 268, 272, 284, [374], 375, 399, 405, 406, 407, 368, 366
Soundesign	030, 050, 062, 193, 239
Soundwave	284
Sova	364
Sowa	213, 237, 238, 192, 193, 283
Spectra	276
Spectravision	192, 193
Spectricon	276
Spectroniq	356
Squareview	214
SR2000	191
Ssanyong	214
SSS	276
Staksonic	239
Standard	276
Standard Component	276
Starlite	276, 284, 239, 240
Strato	276, 284
Studio Experience	248
Sunkai	249
Sunstar	276, 284
Sunwood	284
Superscan	233, 337, 362
Supersonic	276
SuperTech	276, 284
Supra	276, 193
Supre-Macy	032
Supreme	235, 193
Sutron	276
SV2000	218
SVA	285, 170, 267, 249, 338, 339, 340
Sylvania	005, 017, 023, 030, 079, 085, 089, 101, 188, 191, 193, 213, 214, 216, 218, 224, 235, 238, 284, 291, 362
Symphonic	148, 235, 214, 193, 239, 216, 362
Synco	235, 237, 238, 233, 193, 184

Syntax	347, 350, 355
Sysline	284
Tacico	276, 238, 193
Tai Yi	276
Taishan	276, 280
Talent	193
Tandy	233
Tashiko	238, 319, 268
Tatung	036, 124, 235, 276, 272, 284, 213, 218, 237, 191, 192, 201, 221, 205
TCL	241
Teac	276, 284, 191, 319, 214, 193, 296, 241, 215, 216
Tec	276, 284
Tech Line	284
Technics	213, 218, 283, 177, 268
Technovox	188
Techview	335
Techwood	213, 237, 177
Teco	276, 213, 238, 233, 193
Tedex	276
Teiron	276
Teknika	030, 032, 034, 041, 144, 156, 218, 237, 238, 182, 193, 239, 252
Telecolor	244
Telecor	284
Telefunken	284, 285, 253
Telefusion	284
Telegazi	284
Telemeister	284
Telesonic	284
Telestar	276, 284
Teletex	276, 284
Television	284
Tempest	276
Tennessee	284
Tensai	276, 284
Tenson	276
Tera	185, 188, 238, 282
Tevion	284, 194, 356
Textet	276
ThemeScene	345
Thomas	224, 193, 216
Thomson	165, 166, 284, 224, 229
Thorn	316, 284
Tiane	233, 280
TMK	320, 193, 239, 240
TNCi	244
Tobo	276, 170
Tocom	192
Tokai	276, 284
Tokyo	316
Tongtel	285

Tophouse	239, 246
Toshiba	034, 075, 094, 041, 182, 190, 191, 192, 199, 201, 202, 203, 204, 207, 209, 210, 237, 233, 268, 276, 272, 316, 330, 334, 351, 359, 365, 371, 390, 391
Totevision	213
Toyoda	276
Toyomenka	193
Trans Continens	284
TRANS-continents	249
Transonic	276, 284, 285
Trio	356
Triumph	284, 320
Truetone	213, 177
Tuntex	276, 188, 238
TVS	252
Uher	284
Ultra	238
Ultravox	284
Unic Line	284
United	284, 285
Universal	066, 088, 284, 224
Universum	276, 272, 284, 319, 320
Univox	284
V	337, 343, 215, 205
V2max	249
V7 Videoseven	349, 215
Vector Research	188
Vestel	284
Vexa	276, 284
Victor	173, 177, 268
Video Concepts	016
Videocon	284
VideoMac	276
VideoSystem	284
Vidikron	218
Vidtech	193
Viewsonic	336, 337, 343, 215
Viking	032, 237
Vision	284
Vizio	337, 343, 215, 205, 360
Vortec	284
Voxson	284, 193
W	Waltham
Wards	005, 011, 045, 030, 085, 088, 089, 101, 102, 148, 188, 191, 192, 193, 201, 210, 212, 213, 218, 224, 226, 228, 233, 235, 237, 239, 240, 244, 274, 284, 316
Warumaia	185
Watson	276, 284
Waycon	192
Wega	284
Wegavox	276

Weipai	276
Welton	193
Westinghouse	235, 184, 343, 250, 309, 367
Wharfedale	284
White Westinghouse	284, 240, 184, 252, 258, 250
World	239, 240, 184, 252
World-of-Vision	249, 309, 349
X	Xenius
Xiahua	176, 280
Xianghai	276
Xiangyu	276
Xihu	280
Xingfu	276
Xoro	049
XR-1000	191, 214, 239
Xrypton	284
Y	Yamaha
Yamishi	284
Yapshe	177
Yingge	276
Yokan	284
Yoko	276, 284
Yonggu	276
Yorx	188
Youlanasi	208
Yousida	276
Yuhang	276
Z	Zenith
ZhuHai	276
Zonda	276

DEVICE SELECT : DVD

DVD Player	
A	Aiwa 002, 009
	Alba 017, 040
	Apex Digital 002, 040
B	Blaupunkt 040
	Bush 040
C	Clatronic 015
	Creative 001, 017
D	Daewoo 023, 114
	Denon [111]*, 112, 113, 114
	Dual 015
E	Emerson 015, 046
	Entivo 001, 017
F	Finlux 046
	Firstline 023
	Funai 015

G	Gateway 042, 043, 044, 045
	GE 038, 040
	General Electric 038, 040
	Go Video 010, 023, 040
	Goldstar 023, 046
	Gradiente 114
	Grundig 017
H	HITACHI 010
I	Integra 001
	Irradio 023
J	JVC 001, 006, 011, 017
K	Kenwood 114
	KLH 040
	Kloss 002
	Konka 012, 013
L	LG 023, 046
	Luxman 010
M	Magnasonic 015
	Magnavox 001, 015, 017
	Marantz 001, 015, 017
	Metz 003, 008
	Micromedia 001, 017
	Mitsubishi 004, 033
N	NEC 023
O	Optimus 003, 008
P	Panasonic 001, 008, 114
	Panda 040
	Philco 015
	Philips 001, 005, 015, 016, 017
	Pioneer 003, 008, 114
	Pye 017, 023
R	RadioShack 008
	RCA 008, 038, 040
	Realistic 008
	Rotel 006, 011
	Rowa 040
S	Samsung 010, 114
	Sanyo 015, 018, 037
	Schneider 017, 023
	Sharp 015
	Sherwood 040
	Sonic Blue 010, 023
	SONY 002, 010, 019
	SVA 040
	Sylvania 015

	Symphonic 015
T	Teac 008, 015, 040
	Technics 114
	Thomson 038
	Toshiba 001, 010, 017, 021
U	United 015
	Universum 023, 046
Y	Yamaha 016, 017, 114
Z	Zenith 001, 023, 046

CD Player

A	Aiwa 150, 201, 235, 243
B	Burmester 151
	Burmster 202
C	Carvery 150, 202, 203, 235
D	Denon 167, 189, 190, 191, 192, 222, 234, 244
E	Emerson 204, 205, 206, 207
F	Fisher 155, 203, 208, 209, 210
J	JVC 158, 173, 218, 219
	155, 162, 163, 164, 165, 166, 167, 168, 211, 212, 213, 214, 217
K	Kenwood 150, 156, 206, 215, 235
	Marantz 150, 152, 153, 156, 163, 170, 216, 228, 235
	MCS 163, 216, 224
O	Onkyo 159, 177, 178, 179, 180, 181, 182, 183, 184, 185, 225, 227
	Optimus 151, 155, 158, 165, 172, 217, 220, 221, 223, 226
P	Philips 167, 214, 232, 233, 235
	Pioneer 158, 159, 160, 161, 206, 226, 230
S	Sears 206
	Sony 154, 155, 174, 175, 176, 223, 231
T	Teac 152, 153, 154, 202, 209, 228
	Technics 163, 171, 216, 229, 236
W	Wards 150, 155, 158, 172, 186, 235, 237
Y	Yamaha 154, 158, 164, 177, 187, 188, 238, 239, 240, 241
Z	Zenith 242

DEVICE SELECT : HDP

Blu-Ray Disc Player	
D	Denon 038, 039, [111]*
H	Hitachi 034, 035, 036
I	Integra 012
J	JVC 013, 014, 016, 017, 018, 019
L	LG 010
M	Marantz 025, 026
	Mitsubishi 023, 024

O	Onkyo 011, 012
P	Panasonic 001, 002, 003, 040, 041
	Philips 004
	Pioneer 005, 037
R	RCA 011
S	Samsung 006
	Sharp 031, 032, 033, 027, 028, 029, 030
	Sony 007, 008, 009, 015
T	Toshiba 011
Y	Yamaha 020, 021, 022

DEVICE SELECT : DVR

Digital Video Recorder

A	ALCO 011
	ATLM 010
F	Funai 035
H	Hitachi 031, 032, 033, 034, 036, 037
J	JVC [001]*, 002, 003, 004
M	Mitsubishi 038, 039
P	Panasonic 036, 037
	Pioneer 027, 028, 029, 030
S	SANYO 009
	Sharp 040, 041
	SONY 012, 023, 024, 025, 026
T	TOSHIBA 006, 007, 008, 042, 043
V	Victor 020, 021, 022, 040, 041
Y	YAMAHA 005

DEVICE SELECT : VCR

Video Cassette Recorder

A	Admiral 081
	Aiko 095
	Aiwa 009, 026, 027, 070, 072, 082, 083, 084
	Alba 055
	Amstrad 009
	ASA 042
	Asha 087
	Audio Dynamic 005, 085
	Audiovox 088
B	Beaumarck 087
	Broksonic 086, 093
C	Calix 088
	Candle 006, 087, 088, 089, 090
	Canon 049, 057
	Capehart 025, 055, 056, 071

DENON

www.denon.com

D&M Holdings Inc.
Printed in China 5411 10243 007DA