

DENON[®]

DENON HOME SOUND BAR 550

Owner's Manual



What you can do with this unit	5
Accessories	10
Before using the remote control unit	11
Operating range of the remote control unit	12
Part names and functions	13
Sound bar	13
Remote control unit	17
Positioning	19
Positioning the sound bar	19

Connections

Connecting a TV	21
Connection 1: TV equipped with an HDMI connector and compatible with the eARC (Enhanced Audio Return Channel) or ARC (Audio Return Channel)	22
Connection 2: TV equipped with an HDMI connector and incompatible with the eARC or ARC / TV equipped with an optical digital connector	23
Connection 3: TV equipped with an HDMI connector and incompatible with the eARC or ARC / TV equipped with an analog connector	24
Connecting a playback device	25
Connecting an HDMI device	25
Connecting the power cords	26

Playback

Enjoying TV, movies and music	27
Adjusting the volume	28
Adjusting the bass volume	28
Turning off the sound temporarily (Muting)	28
Listening to music on a Bluetooth device	29
Pairing a Bluetooth device for the first time	29
Pairing with other Bluetooth devices	30
Listening to music with a paired Bluetooth device	30
Getting the HEOS App	31
Setting up first HEOS built-in device	32
Adding more HEOS built-in devices	33
HEOS Account	34
Playing from streaming music services	35
Listening to the same music in multiple rooms	38



Listening to Internet Radio	42
Playing music stored on your mobile	43
Playing back files stored on a PC or NAS	44
Playing music from a USB flash drive	45
AirPlay function	46
Playing songs from your iPhone, iPod touch or iPad	47
Playing iTunes music with this unit	47
Play a song from your iPhone, iPod touch or iPad on multiple synced devices (AirPlay 2)	48
Spotify Connect function	49

Settings

Settings	50
Adjusting the audibility of dialog and vocals (Dialog enhancer)	50
Setting the night mode	50
Setting the sound mode	51
Quick select function	56
Operating this unit using the remote control of a TV	57
Wirelessly connecting the HEOS built-in speakers as surround speakers	58
Operating this unit by voice with the Amazon Alexa function	59
Setting the input source to switch with the TV button on the remote control unit	60

Tips

Troubleshooting	61
Power does not turn on / Power is turned off	62
Operations cannot be performed through the remote control unit	62
Trouble teaching this unit remote control commands	63
No sound comes out	63
Music cuts out or delays sometimes	64
The HDMI Control function does not work	64
Audio can be heard coming from the TV's speakers	64
I hear a delay when using the external input with my TV	65
Bluetooth playback does not work	65
Cannot connect the sound bar to the network	66
Connecting to a network using an iOS device	66
Connecting to a WPS network	67
This unit takes long time to turn on	67
Cannot operate the unit with Alexa	68
Alexa does not respond even if called	68
Resetting factory settings	69
Resetting the firmware to the default state	70



Appendix

About HDMI	71
Power management	72
Power modes	72
Status LED table	74
Supported file types and codecs	81
Supported audio formats (Optical)	81
Trademark information	82
Specifications	84
Sound bar	84
Licence	87



Thank you for purchasing this Denon product.

To ensure proper operation, please read this owner's manual carefully before using the product.

After reading this manual, be sure to keep it for future reference.

What you can do with this unit

This sound bar supports immersive surround sound and enables you to connect this unit to your TV to enjoy high-quality sound.

In addition to Dolby Atmos and DTS:X playback, traditional audio signals can also be enjoyed in virtual 3D audio.

This unit is equipped with an HDMI input/output connector that supports 4K and enables passthrough of 4K video signals to your TV, such as signals for Blu-ray disc players and video game consoles.



■ Playing TV audio

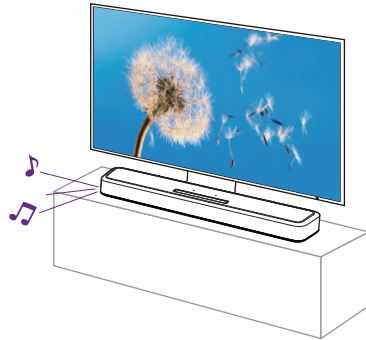

[Related information]

- “Connecting a TV” (👉 p. 21)
- “Enjoying TV, movies and music” (👉 p. 27)

■ Connecting to a playback device such as a Blu-ray disc player to perform playback

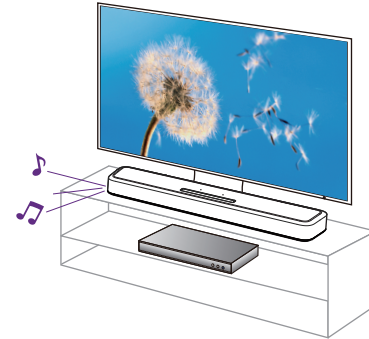

[Related information]

- “Connecting a TV” (👉 p. 21)
- “Connecting an HDMI device” (👉 p. 25)
- “Enjoying TV, movies and music” (👉 p. 27)



■ Operating by talking to Alexa

NOTE

- Optional Alexa Built-in functionality will become available via a future firmware update.

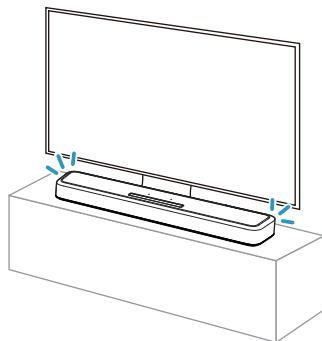

- Alexa, turn up the volume
- Alexa, what's the weather today?



- Alexa isn't available in certain languages and countries.

[Related information]

- “Operating this unit by voice with the Amazon Alexa function” (📖 p. 59)

■ Using the app for smartphones/tablets (HEOS App) for easy operation

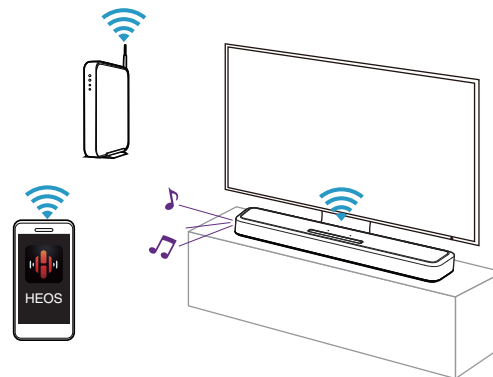

[Related information]

- “Getting the HEOS App” (📖 p. 31)



■ Playing streaming audio with Wi-Fi

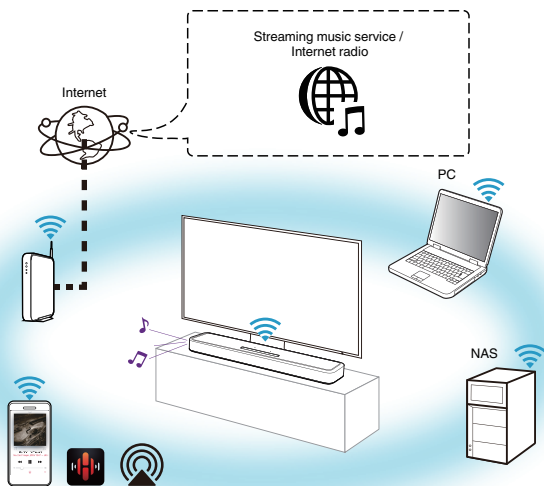

[Related information]

- "Playing from streaming music services" (☞ p. 35)
- "Listening to Internet Radio" (☞ p. 42)
- "Playing music stored on your mobile" (☞ p. 43)
- "Playing back files stored on a PC or NAS" (☞ p. 44)
- "AirPlay function" (☞ p. 46)
- "Spotify Connect function" (☞ p. 49)



■ Playing a USB flash drive

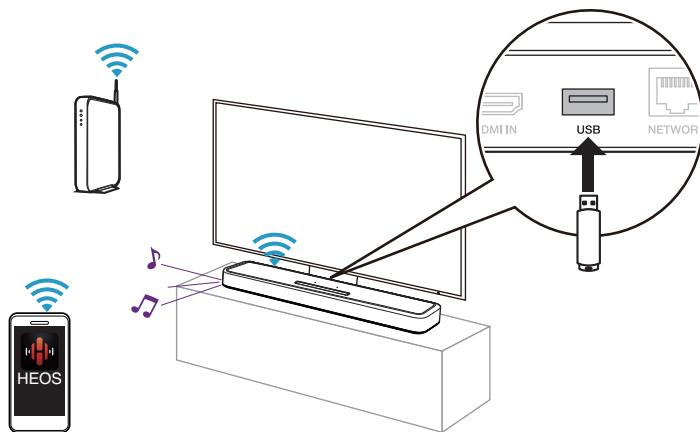

[Related information]

- “Playing music from a USB flash drive” (👉 p. 45)

■ Playing a Bluetooth device

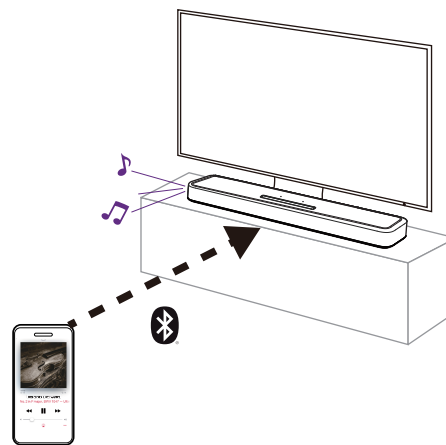









[Related information]

- “Listening to music on a Bluetooth device” (👉 p. 29)

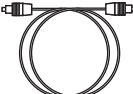
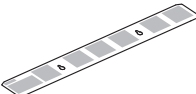

Accessories

Check that the following parts are supplied with the product.

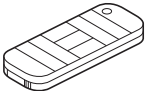
 <p>Quick Start Guide</p>	 <p>Safety Instructions</p>	 <p>Warranty (North America model only)</p>	 <p>Power cord (for Europe model)</p> <p>or</p>  <p>Power cord (for North America model)</p>	
 <p>HDMI cable (4K)</p>	 <p>Optical digital cable</p>	 <p>Wall mount template</p>	 <p>Wall mount spacers</p>	 <p>Remote control unit (RC-1241 / Built-in battery)</p>



Before using the remote control unit

The remote control unit has a built-in lithium battery.

Pull out the insulation sheet before use.

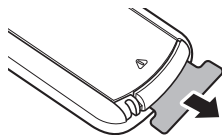

Replacing the battery

1. Lightly slide the catch of the battery case on the back of the remote control in the rightward direction.

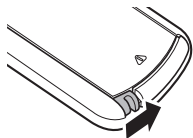

2. While pushing the catch lightly to the right, pull out the battery case.

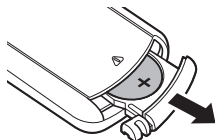

3. Remove the old battery, then insert a new coin-shaped lithium battery (CR2025) into the battery compartment so that the + symbol engraved on the battery faces upwards.
4. Replace the battery case in the original position.

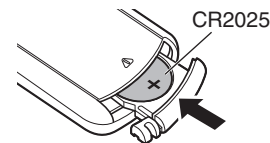

NOTE

- If the battery should have a leakage, immediately replace and dispose of the battery. In this case, there is a risk of burn when the liquid comes in contact with skins or clothes, so a great care should be taken. If the liquid accidentally comes in contact, wash with tap water and consult a doctor.
- Remove the battery from the remote control unit if it will not be in use for long periods.



Operating range of the remote control unit

Point the remote control unit at the remote sensor when operating it.

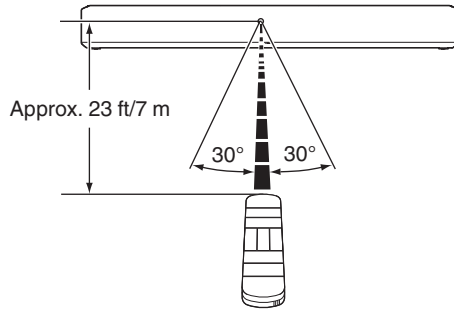

Part names and functions

Sound bar

■ Top panel

Hold your hand over the top of the sound bar to show the operation panel keys. Touch these keys to perform operations. Moving your hand away from the area hides the keys.

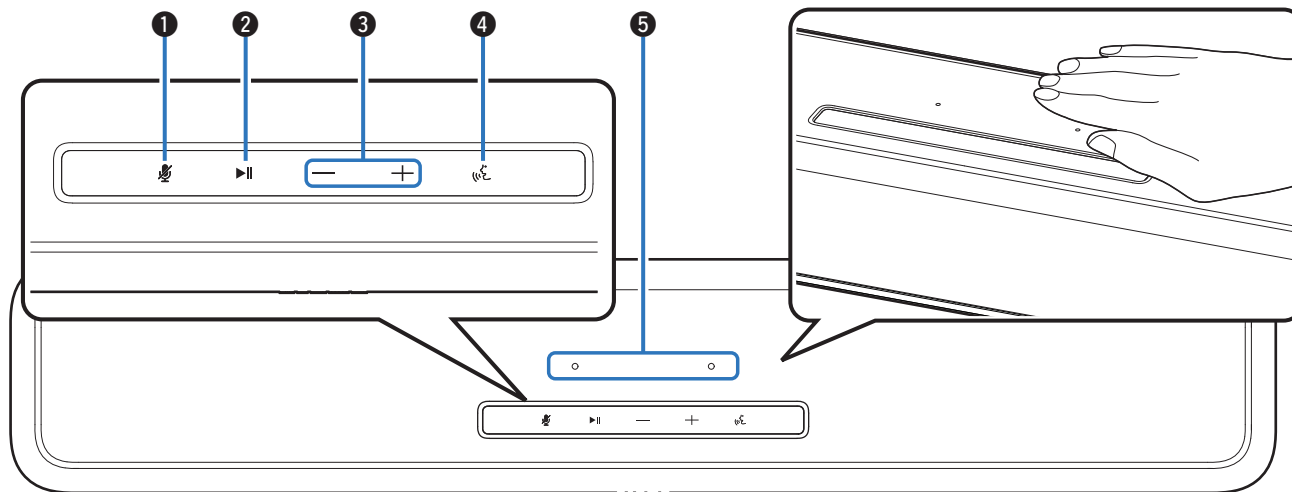

For details, see the next page.



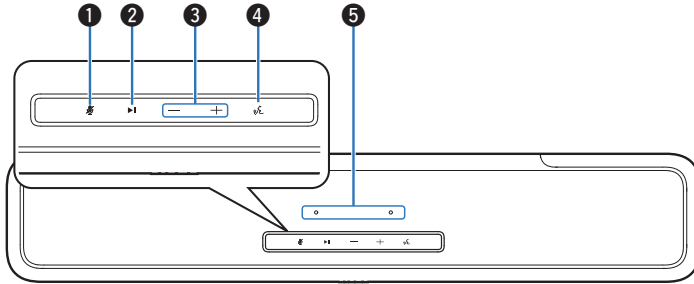

1 Microphone off key (🔇)

This disables the microphone function. In the state with the microphone function disabled, Alexa does not respond even if called. Use this in cases such as when you want to protect your privacy. (👉 p. 59)

2 Play/Pause key (▶️/⏸️)

- Press this key to pause during playback. If pressed while paused or stopped, resumes playback from the last track played.
- Press the key twice to play the next track.
- Press the key three times to restart the current track or play the previous track.
- Press and hold the key for 5 seconds to enter deep standby mode. (👉 p. 73)

3 Volume keys (+, -)

These adjust the volume level. (👉 p. 28)

4 Action key (🗨️)

This calls Alexa. You can use voice control without saying “Alexa”. (👉 p. 59)

5 Microphone

This is the microphone to talk to Alexa. (👉 p. 59)



- Do not put anything on top of the sound bar. Doing so may lead to accidental operations.
- The light of the operation panel keys is activated using a small amount of static electricity from the human body. Due to the nature of this mechanism, the keys may light up or blink due to noise from the surrounding environment or connection cables, but it is not malfunctioning.



■ Front panel

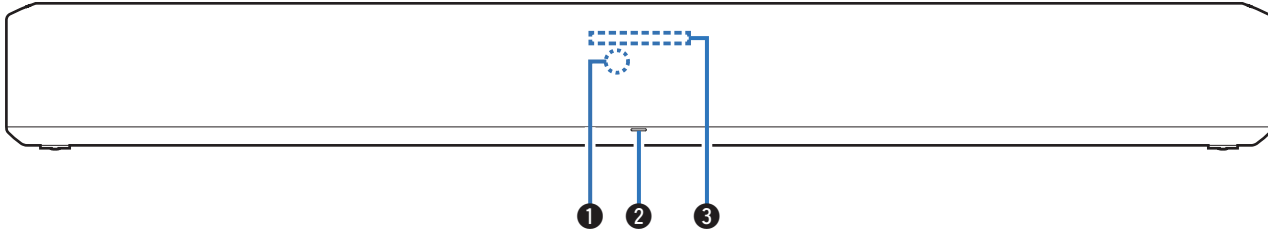

① Remote control sensor

This receives signals from the remote control unit. (👉 p. 12)

② Status LED

Please refer to the “Status LED table” (👉 p. 74) for LED color and state meaning.

③ Light bar

While Alexa responds, the LED lights up. (👉 p. 59)



■ Rear panel

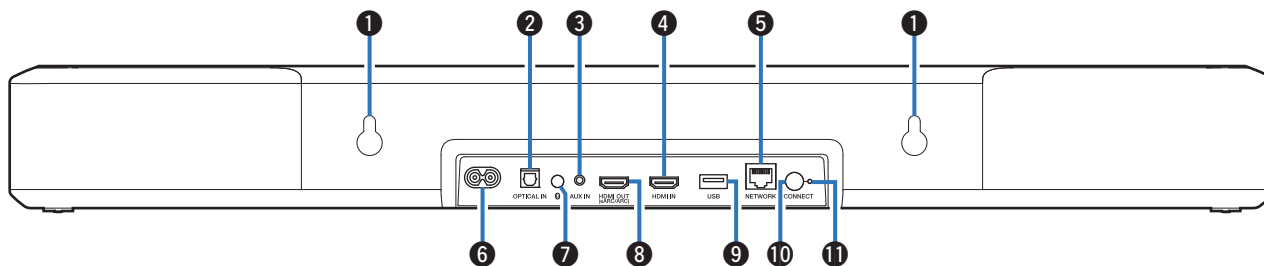

❶ Wall hook hole

Used to mount the sound bar on a wall. (👉 p. 20)

❷ Optical digital input connector (OPTICAL IN)

Use the included optical cable to connect a TV with an optical digital terminal. (👉 p. 23)

❸ Analog audio input connector (AUX IN)

Use a commercially available 3.5 mm stereo audio cable to connect a TV with an AUX audio output connector. (👉 p. 24)

❹ HDMI IN connector

Used to connect to the HDMI equipment with an HDMI cable. (👉 p. 25)

❺ NETWORK connector

Used to connect this unit to a wired Ethernet network. (👉 p. 33)

❻ Power inlet

Used to connect the power cord. (👉 p. 26)

❼ Bluetooth button (🌐)

- Switches the input source to “Bluetooth”. (👉 p. 29)
- Used to pair with Bluetooth devices. (👉 p. 29)

❽ HDMI OUT connector (eARC/ARC)

Use the included HDMI cable to connect an eARC or ARC function-compatible TV. (👉 p. 21)

❾ USB port

This is used to connect USB storages (such as USB flash drives). (👉 p. 45)

❿ CONNECT button

Used for Wi-Fi setup.

⓫ CONNECT LED

Indicates the status of this unit. (👉 p. 74)



Remote control unit

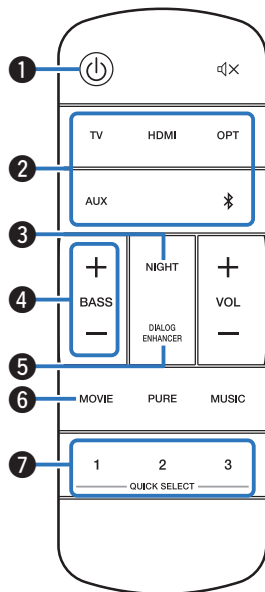

1 Power operation button (⏻)

- Press the button to turn the sound bar power on/off (quick start mode). (📖 p. 27)
- Press and hold the button for 5 seconds to enter deep standby mode. (📖 p. 73)

2 Input source buttons (TV, HDMI, OPT, AUX, 📶)

This selects the input source. (📖 p. 27)

3 Night mode button (NIGHT)

Compresses the dynamic range (difference between loud and soft sounds) to make audio easier to hear at low volumes. (📖 p. 50)

4 Bass volume control buttons (BASS +, -)

This setting adjusts the volume level for the bass. (📖 p. 28)

5 Dialog enhancer button (DIALOG ENHANCER)

Adjust the volume of dialog in movies, vocals in music, etc. so these can be heard more easily. (📖 p. 50)

6 Movie mode button (MOVIE)

Switches to the sound mode suitable for enjoying movies and TV programs. (📖 p. 51)

7 Quick select buttons (QUICK SELECT 1 - 3)

Register input source, volume level and sound mode, night mode and dialog enhancer settings to these buttons or recall those settings. (📖 p. 56)

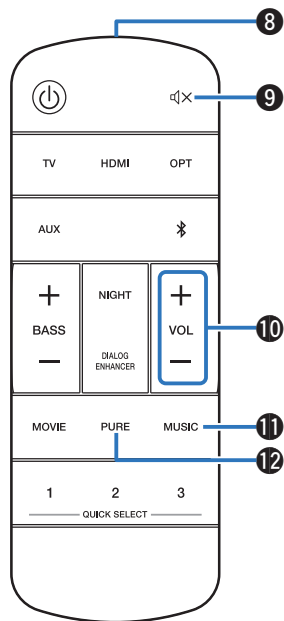

**8 Remote control signal transmitter**

This transmits signals from the remote control unit. (👉 p. 12)

9 Mute button (🔇)

This mutes the output audio. Press again to unmute. (👉 p. 28)

10 Volume buttons (VOL +, -)

These adjust the volume level. (👉 p. 28)

11 Music mode button (MUSIC)

Switches to the sound mode suitable for enjoying music. (👉 p. 51)

12 Pure mode button (PURE)

Enjoy high quality sound that is faithful to the original source. (👉 p. 51)



Positioning

Positioning the sound bar

Position the sound bar in front of your TV, etc., on a flat surface.

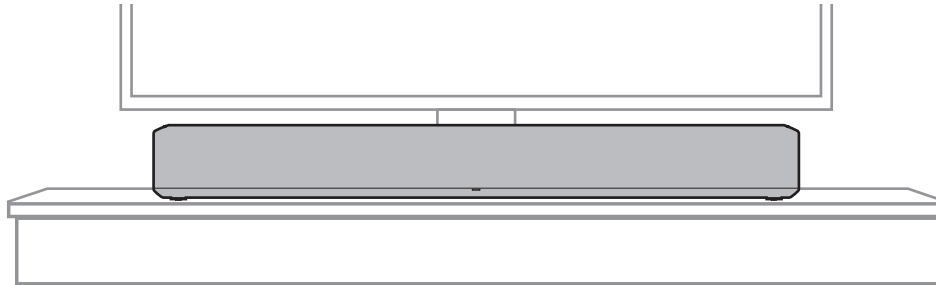

- When positioning the sound bar in front of your TV, make sure the sound bar does not obstruct the TV's remote control light sensor, etc.



■ When hanging the sound bar on a wall

The sound bar has a wall hook hole to hang it on a wall. When hanging it on a wall, position it in a flat, vertical position.

To ensure safety, request a contractor perform the mounting work when mounting onto a wall.

NOTE

- In order to use the unit safely, do not place items on or hang items from the unit.
- Be sure to fix connection cables to the wall to ensure that cannot be pulled or tripped over causing this unit to fall. Check that the unit is mounted safely after the mounting work is complete.
- Also, periodically check the safety of this unit and whether there is a possibility that the unit may fall.
- Denon cannot accept any responsibility for damage, injury or accidents caused by problems with the mounting location or mounting method.

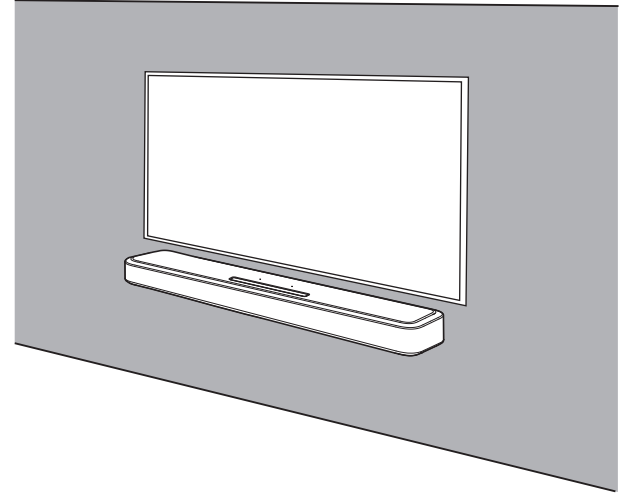

- When hanging it on a wall, use the included wall mount template.

[How to use the wall mount template]

- ① Affix the template to the location you would like to mount the sound bar.
- ② Screw in the wall mount screws by following the template.
Consult a construction professional about the proper wall mount screws for the material and strength of your wall.
- ③ Remove the template from the wall.
- ④ Mount the included wall mount spacer on the spine of the sound bar.
Mounting the wall mount spacer creates a space for cords to pass through between the sound bar and the wall.
- ⑤ Mount the sound bar on the wall.



Connecting a TV

How to connect a TV depends on the connectors and functions equipped on the TV.



- Enable the TV's HDMI control function when using an HDMI cable to connect this unit to your TV. (See the TV owner's manual for details.)
- Turn off the TV's speaker or minimize the volume when using this unit.

Roku TV Ready™

- The Soundbar is Roku TV Ready certified. Connect the Soundbar to a Roku TV™ with the included HDMI cable and follow the on-screen setup instructions.



Connection 1: TV equipped with an HDMI connector and compatible with the eARC (Enhanced Audio Return Channel) or ARC (Audio Return Channel)

Use the included HDMI cable to connect this unit to an eARC or ARC function-compatible TV.

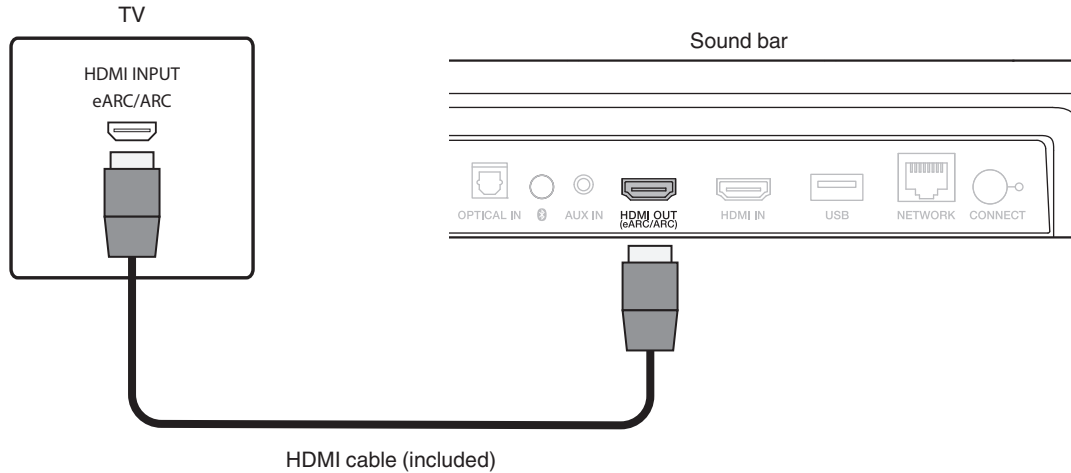

- The TV also needs to be compatible with the eARC or ARC function.



Connection 2: TV equipped with an HDMI connector and incompatible with the eARC or ARC / TV equipped with an optical digital connector

Use the included HDMI and optical cables to connect this unit to your TV.

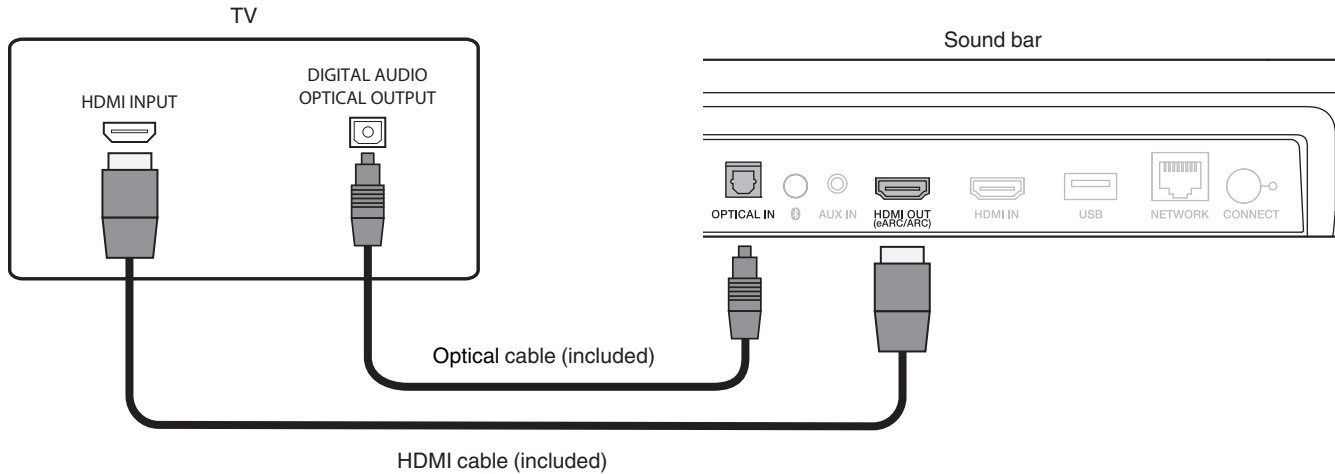

- Line up the optical cable with the shape of the terminal to insert.



Connection 3: TV equipped with an HDMI connector and incompatible with the eARC or ARC / TV equipped with an analog connector

Use the included HDMI cable and a commercially available 3.5 mm stereo audio cable to connect this unit to your TV.

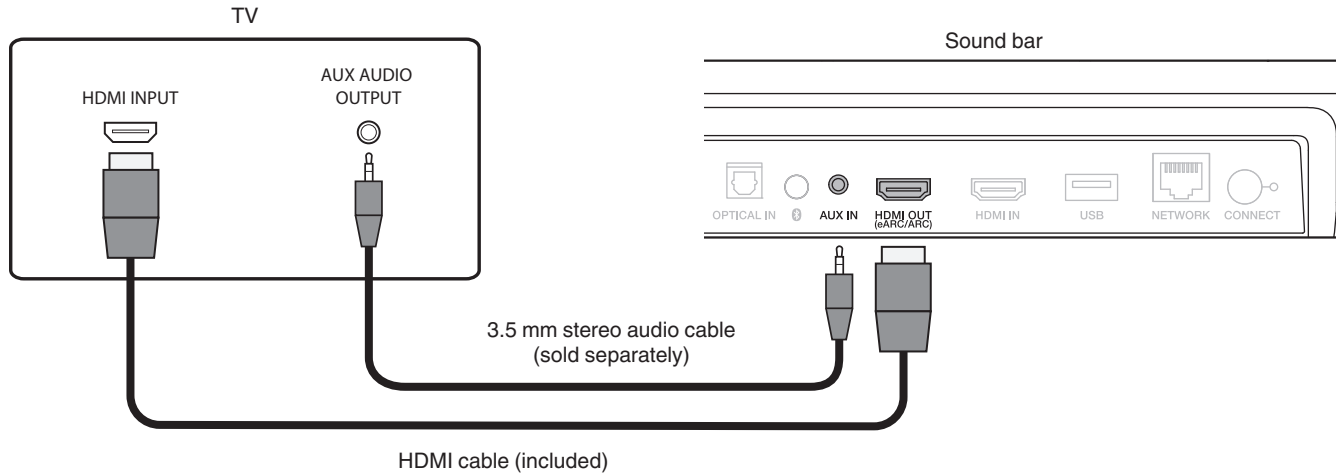

Connecting a playback device

Connecting an HDMI device

Use a commercially available HDMI cable to connect a Blu-ray disc player, game device or similar device to this unit.

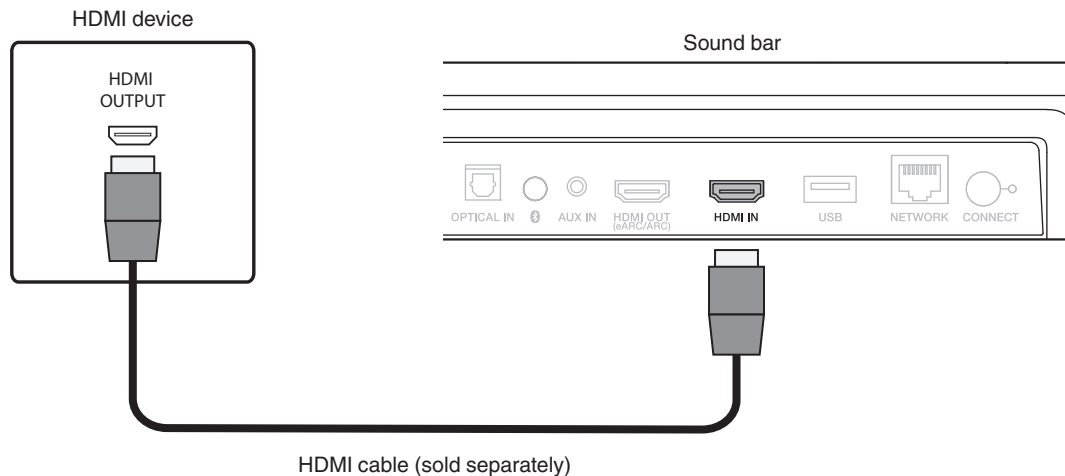

- When connecting this unit to a device that is compatible with the 4K functions, use a “High Speed HDMI cable with Ethernet” that displays the HDMI logo.



Connecting the power cords

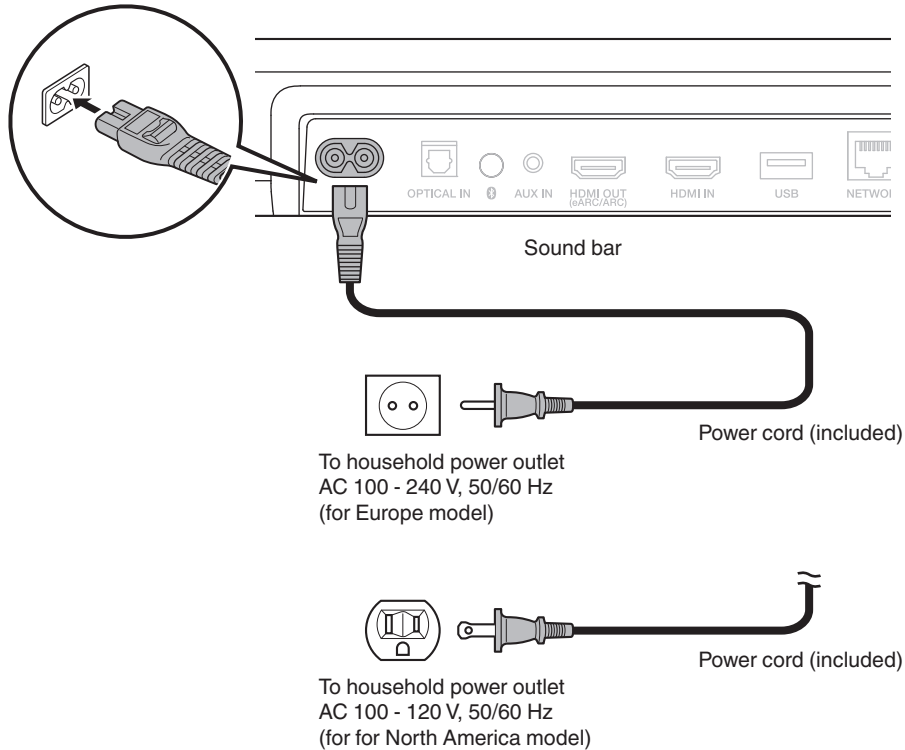

Enjoying TV, movies and music

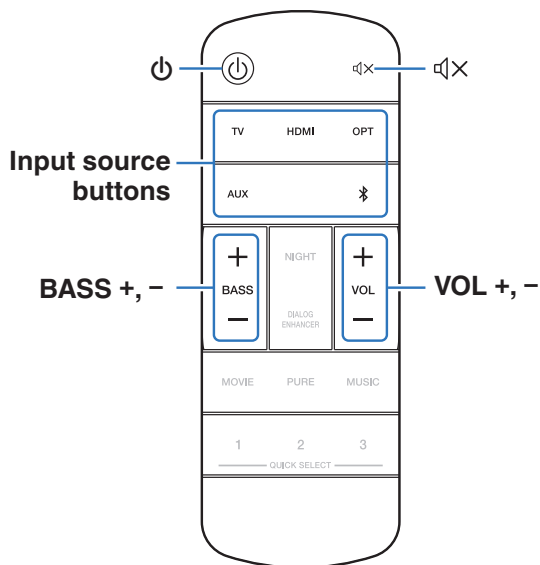

1 Turn on the power of the TV and connected devices.

2 Press  to turn on power to the sound bar.

3 Press the input source button.

When the button is pressed, the status LED blinks in blue, and the input source switches.

TV:	Switches the input source to TV (Default: HDMI OUT (eARC/ARC)).
HDMI:	Switches the input source to HDMI IN.
OPT:	Switches the input source to OPTICAL IN.
AUX:	Switches the input source to AUX IN.
Bluetooth:	Switches the input source to Bluetooth.

4 Play the device connected to this unit.

For details, see the relevant device manual.



- Connect an HDMI control-compatible TV and this unit via HDMI and enable the HDMI control to enable linked control from either device. (🔗 p. 71)



Adjusting the volume

1 Use VOL + or VOL – to adjust the volume.

When the buttons are pressed, the status LED blinks in blue, and the volume increases or decreases.

Adjusting the bass volume

1 Use BASS + or BASS – to adjust the bass volume.

When the buttons are pressed, the status LED blinks in blue, and the bass volume increases or decreases.

Turning off the sound temporarily (Muting)

1 Press .

The status LED blinks slowly in blue.



- To cancel mute, either adjust the sound volume or press  again.



Listening to music on a Bluetooth device

Music files stored on Bluetooth devices such as smartphones, digital music players, etc. can be enjoyed on this unit by pairing and connecting this unit with the Bluetooth device.

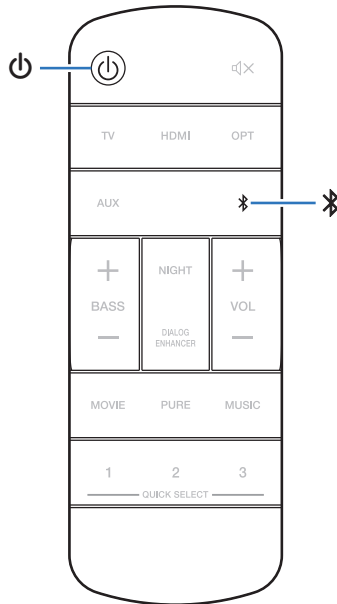

Pairing a Bluetooth device for the first time



Pair a Bluetooth device with this unit.

Once the Bluetooth device has been paired, it does not need to be paired again.

- 1** Press **⏻** to turn on power to the unit.
- 2** Press **📶** to switch the input source to “Bluetooth”.
Automatically switches to pairing mode the first time it is used.
In pairing mode, the status LED repeatedly blinks 2 times in green.
- 3** Activate the **Bluetooth** settings on your **Bluetooth** device.
- 4** Select **“Denon Home Sound Bar 550” (Default)** from the list of devices displayed on the screen of the **Bluetooth** device.
The status LED blinks in blue and this unit and the Bluetooth device are paired.





Pairing with other Bluetooth devices

- 1 Press  to turn on power to the unit.**
- 2 Press  to switch the input source to “Bluetooth”.**
- 3 Activate the Bluetooth settings on your Bluetooth device.**
- 4 Press and hold  for 3 seconds.**

This unit enters pairing mode, and the status LED repeatedly blinks 2 times in green.
- 5 Select “Denon Home Sound Bar 550” (Default) from the list of devices displayed on the screen of the Bluetooth device.**

The status LED blinks in blue and this unit and the Bluetooth device are paired.

Listening to music with a paired Bluetooth device

- 1 Press  to turn on power to the unit.**
- 2 Press  to switch the input source to “Bluetooth”.**
- 3 Activate the Bluetooth settings on your Bluetooth device.**

The status LED blinks in blue and connects to the last Bluetooth device connected. If the connection is cut, perform connection again.
- 4 Play music using any app on your Bluetooth device.**



Getting the HEOS App

You can use many online music streaming services from the HEOS App. Depending upon your geographical location, there are several options to choose from.

Download the HEOS App for iOS or Android by searching App Store, Google Play store or Amazon Appstore for "HEOS".



Setting up first HEOS built-in device

Once you have placed this unit in your listening room and have downloaded the HEOS App, you are ready to configure this unit for music playback. This involves following a few simple steps to get this unit connected to your existing home network:



- DO NOT connect the Ethernet cable if you are connecting this unit to a wireless network. If you are connecting this unit to a wired network, use an Ethernet cable sold separately to connect this unit to your network or router.

1 Make sure your mobile device is connected to your wireless network (the same network this unit connected to).

You can check this in the “Settings” - “Wi-Fi” menu of your iOS or Android device.



- Activate the Bluetooth setting on your mobile device.
- If your wireless network is secure, make sure you know the password to join your network.

2 Launch the HEOS App on your mobile device.



3 Tap the “Setup Now” button at the top of the screen.

4 Follow the instructions to add this unit to your wireless network and to select an input on this unit.



Adding more HEOS built-in devices

The HEOS system is a true multiroom audio system that automatically synchronizes audio playback between multiple HEOS built-in devices so that the audio coming from different rooms is perfectly in sync and always sounds amazing! You can easily add up to 32 HEOS built-in devices to your HEOS system.

■ Adding wired HEOS built-in devices

Just connect the HEOS built-in devices to your home network using an Ethernet cable and the HEOS built-in device will appear on your HEOS App as a new room in the Rooms screen.

At your convenience, you can assign a name to the HEOS built-in device to indicate which room you have it placed in.



- Use only a shielded STP or ScTP LAN cable which is easily available at electronics stores (CAT-5 or greater recommended).
- Do not connect a NETWORK connector directly to the LAN port/Ethernet connector on your computer.

■ Adding wireless HEOS built-in devices

You can add additional wireless HEOS built-in devices to your HEOS system by selecting “Add Device” from the HEOS App’s settings menu and follow the instructions:

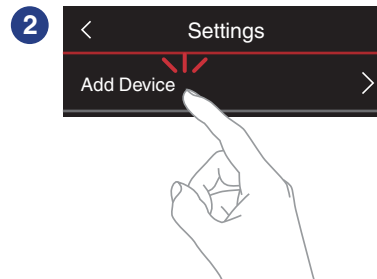
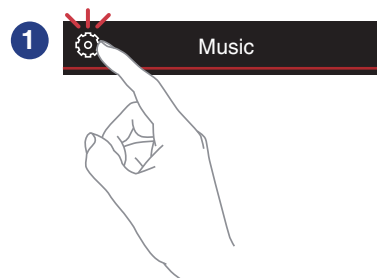

HEOS Account

HEOS Accounts can be registered by tapping “Music” tab - “Settings” icon  in the HEOS App.

■ What is a HEOS Account?

A HEOS Account is master account or “keychain” for managing all of your HEOS music services with one single username and password.

■ Why do I need a HEOS Account?

With the HEOS Account you just have to enter your music services login names and passwords one time. This allows you to easily and quickly use multiple controller apps on different devices.

You just log into your HEOS Account on any device and you will have access to all of your associated music services, play history and custom playlists, even if you are at a friend’s house listening to music on their HEOS system.

■ Signing up for a HEOS Account

You will be instructed to signup for a HEOS Account the first time you try to access any music service from the main “Music” menu of the HEOS App.

■ Changing your HEOS Account

- 1 Tap the “Music” tab.**
- 2 Select the Settings icon  in the upper left corner of the screen.**
- 3 Select “HEOS Account”.**
- 4 Change your location, change your password, delete your account or sign out of your account.**



Playing from streaming music services

A music service is an online music company that provides access to vast music collections via free and/or paid subscriptions. Depending upon your geographical location, there are several options to choose from.

NOTE

- The HEOS App and brand is not affiliated with any manufacturer of any mobile device. Availability of music services may vary by region. Not all services may be available at time of purchase. Some services may be added or discontinued from time to time based on decisions of the music service providers or others.

■ Selecting a room/device

- 1 Tap the “Rooms” tab, and select “Denon Home Sound Bar 550” if there are multiple products with HEOS built-in.



- Tap the Pencil icon  at the top right to switch edit mode. You can change the displayed name.

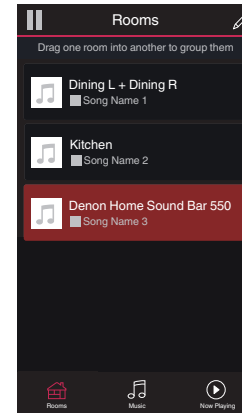

■ Selecting the music track or station from music sources

1 Tap the “Music” tab and select a music source.



- All music services displayed may not be available in your location.

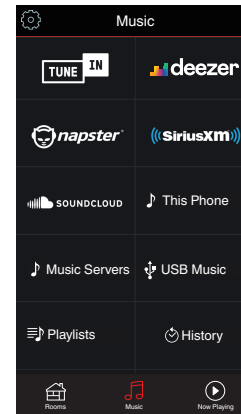

2 Browse the music to play.

After selecting a music track or radio station the app will automatically change to the “Now Playing” screen.



- When you select a music track to play you will be asked how you want to queue up your music.

Play Now:	Inserts the item into the queue after the currently playing track and plays the selected item immediately.
Play Now & Replace Queue:	Clears the queue and plays the selected item immediately.
Play Next:	Inserts the item into the queue after the current song and plays it when the current song ends.
Add to End of Queue:	Adds the item to the end of the queue.



- When you select a radio station the following items are displayed.

Play Now:	Plays the selected item immediately.
Add to HEOS Favorites:	Adds to HEOS Favorites.

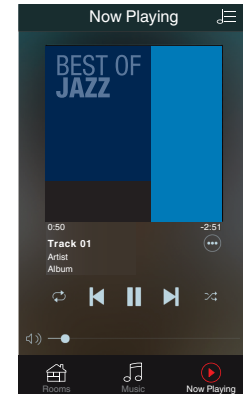
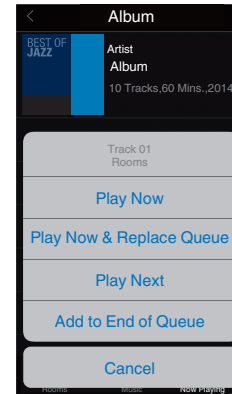

Listening to the same music in multiple rooms

This system is a true multi-room audio system. You can create one or more HEOS groups to automatically synchronize audio playback between multiple products with HEOS built-in so that the music playing different rooms is perfectly in sync and always sounds amazing! You can easily add up to 32 products to your system in total. You can group up to 16 individual products to have them play the same song fully synchronized.

■ Grouping rooms

- 1** Press and hold your finger on room that is not playing music.
- 2** Drag it into the room that is playing music (indicated by the red outline) and lift your finger.
- 3** The two rooms will be grouped together into a single device group and both rooms will be playing the same music in perfect sync.

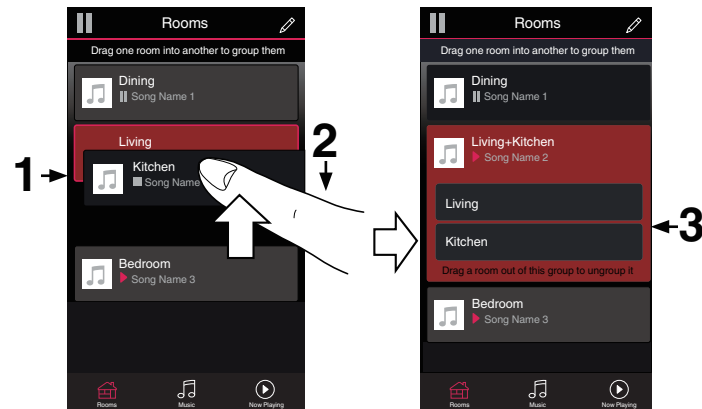

■ Ungrouping rooms

- 1 Press and hold your finger on room that you want to remove from the group.
- 2 Drag it out of the group and lift your finger.

NOTE

- You can not remove the first room that started playing the music before grouping.

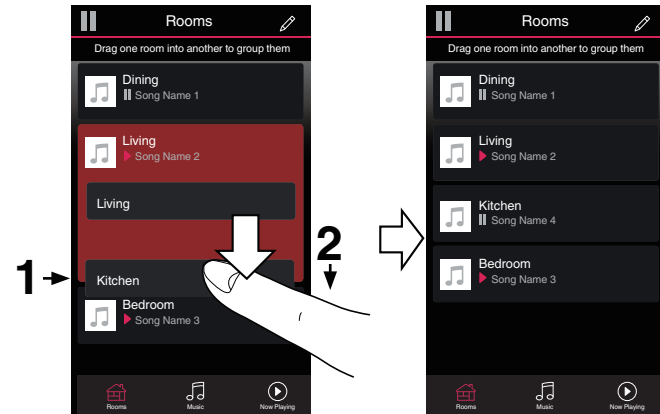

■ Grouping all rooms (party mode)

You can easily group 16 rooms together into Party Mode by using a "pinch" gesture.

- 1** Place two fingers on the screen over the list of rooms.
- 2** Quickly pinch your two fingers together and release.
- 3** All of your rooms will be joined together and begin playing the same music in perfect sync.



■ Ungrouping all rooms

You can easily ungroup all of your rooms and exit Party Mode by using a "spread" gesture.

- 1 Place two fingers close together on the screen over list of rooms.**
- 2 Quickly spread your two fingers apart from each other and release.**
- 3 All of your rooms will be ungrouped.**



Listening to Internet Radio

The HEOS system includes access to more than 100,000 free internet radio streams from all corners of the globe via the Tuneln radio service. Just select the Tuneln logo from the main “Music” menu and browse among the 100,000 stations neatly organized into popular categories and select a station that appeals to your mood.



- If you have a Tuneln account, you can sign into the Tuneln service under “Settings” - “Music Sources” - “Tuneln”, and access all of your “My Favorites” Tuneln stations.

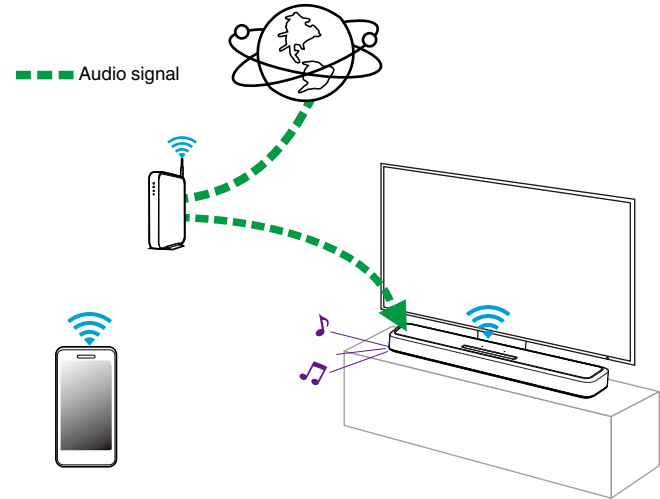

Playing music stored on your mobile

Perform this operation on the HEOS App. Download the HEOS App in advance to your iOS or Android device. (🔗 p. 31)

- 1 Tap the “Music” tab.
- 2 Select “This iPhone/iPod/iPad/Phone”.
- 3 Browse the local music on your phone and select something to play.

— Audio signal

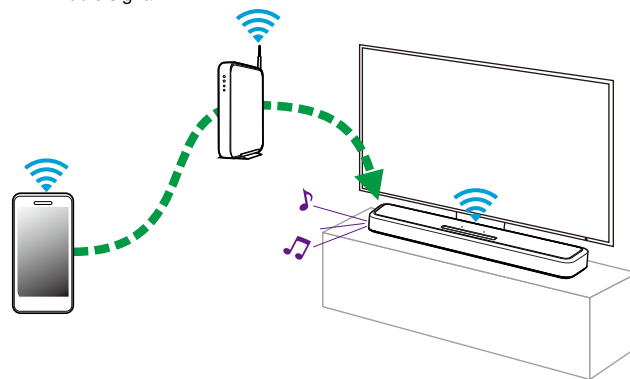

Playing back files stored on a PC or NAS

Perform this operation on the HEOS App. Download the HEOS App in advance to your iOS or Android device. (☞ p. 31)

- 1 Select “Music Servers” from the “Music” tab.
- 2 Select the name of your networked PC or NAS (Network Attached Storage) server.
- 3 Browse the music on your PC/NAS and select something to play.

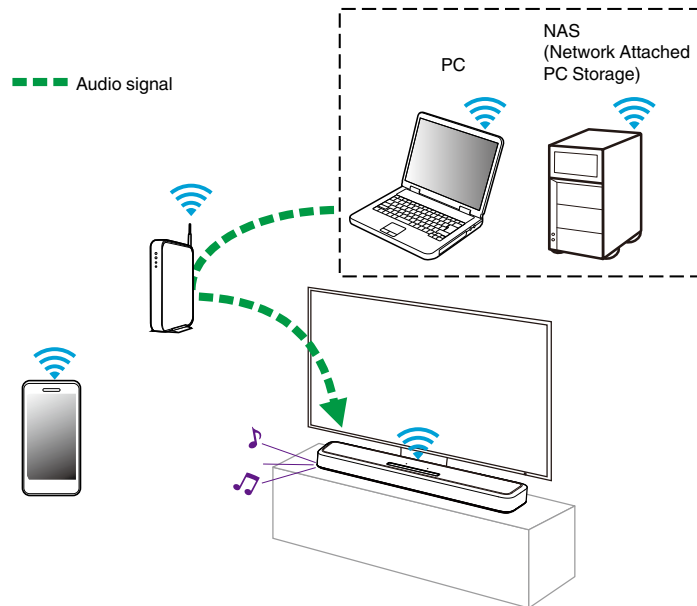

Playing music from a USB flash drive

Perform this operation on the HEOS App. Download the HEOS App in advance to your iOS or Android device. (🔗 p. 31)

- 1** Insert a FAT32 or NTFS formatted USB flash drive into the USB port on the rear panel of the sound bar.
- 2** Select “USB Music” from the “Music” tab.
- 3** Select the name of this unit.
- 4** Browse the music on your USB flash drive and select something to play.



- It may take several minutes for the name of this unit to appear in the “USB Music” list if you have a large number of files on your USB flash drive.
- It is not possible to connect and use a computer via the USB port of this unit using a USB cable.

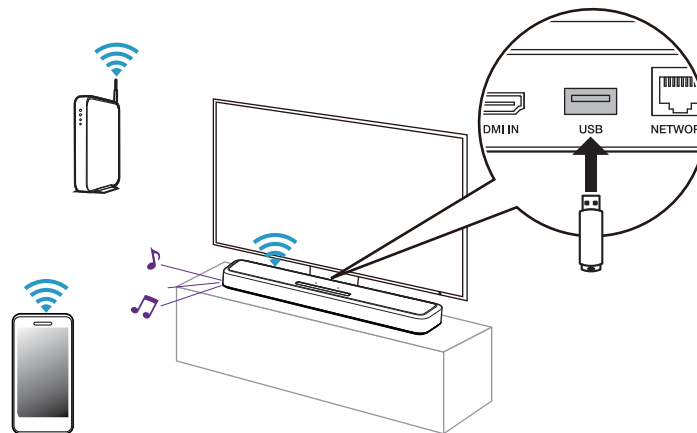

AirPlay function

Music files stored on your iPhone, iPod touch, iPad or iTunes can be played on this unit via the network.



- The screen may differ depending on the OS and software versions.

This unit supports AirPlay 2®.

Sync multiple AirPlay 2 compatible devices/speakers for simultaneous playback.



- This unit supports AirPlay 2 and requires iOS 11.4 or later.

— Audio signal

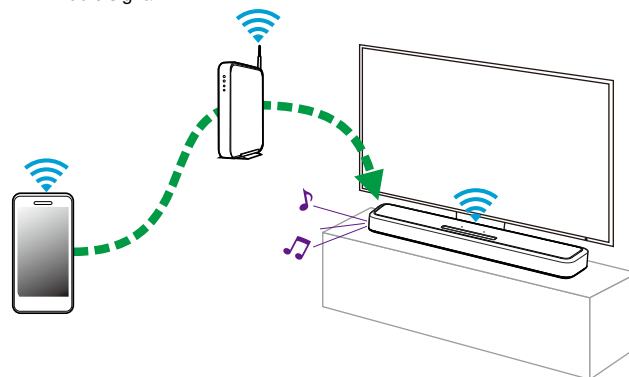

Playing songs from your iPhone, iPod touch or iPad

If you update your “iPhone/iPod touch/iPad” to iOS 10.0.2 or later, you can stream music stored in your “iPhone/iPod touch/iPad” directly to this unit.

1 Connect your iPhone, iPod touch or iPad Wi-Fi to the same network as this unit.

- For details, see your device’s manual.

2 Play the song on your iPhone, iPod touch or iPad.

AirPlay icon is displayed on the iPhone, iPod touch or iPad screen.

3 Tap the AirPlay icon and select this unit.

[Example] iOS 12



[Example] iOS 10



Playing iTunes music with this unit

- 1 Install iTunes 10, or later, on a Mac or Windows PC that is connected to the same network as this unit.
- 2 Start iTunes and click the AirPlay icon to select this unit.

[Example] iTunes



3 Choose a song and click play in iTunes.

The music will stream to this unit.



Play a song from your iPhone, iPod touch or iPad on multiple synced devices (AirPlay 2)

Songs from an iPhone, iPod touch or iPad operating iOS 11.4 or later can be synced with multiple AirPlay 2 supported devices for simultaneous playback.

1 Play the song on your iPhone, iPod touch or iPad.

AirPlay icon is displayed on the iPhone, iPod touch or iPad screen.



2 Tap the AirPlay icon.

Displays a list of devices/speakers that can be played back on the same network.

- A circle is displayed to the right of AirPlay 2 compatible devices.

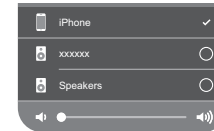

3 Tap the devices/speakers you want to use.

- Multiple AirPlay 2 compatible devices can be selected.
- Volume can be adjusted for each device individually or for all synced devices simultaneously.



Spotify Connect function

Spotify is all the music you'll ever need. Millions of songs available instantly. Just search for the music you love, or let Spotify play you something great. Spotify works on your phone, tablet, computer and home speakers. So you'll always have the perfect soundtrack for whatever you're doing. Now you can enjoy Spotify with your free account as well as Premium account. Use your phone, tablet or computer as a remote control for Spotify. Go to **www.spotify.com/connect** to learn how.

The Spotify software is subject to third party licenses found here:
www.spotify.com/connect/third-party-licenses



Settings

Perform the below operations and settings as needed.

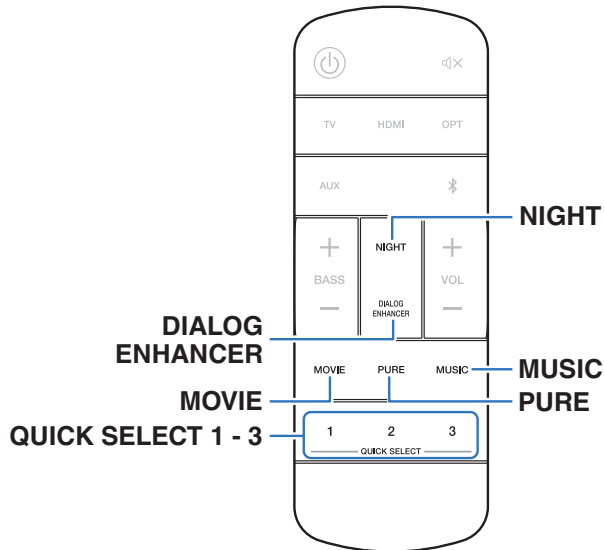

Adjusting the audibility of dialog and vocals (Dialog enhancer)

Adjust the volume of dialog in movies, vocals in music, etc. so these can be heard more easily.

1 Press DIALOG ENHANCER.

When the button is pressed, the status LED blinks in blue, and the settings switch.

Off / Low / Medium / High (Default: Off)

Setting the night mode

Compresses the dynamic range (difference between loud and soft sounds) to make audio easier to hear at low volumes.

1 Press NIGHT.

When the button is pressed, the status LED blinks in blue, and night mode switches between on/off.



Setting the sound mode

This unit allows you to enjoy various kinds of surround and stereo playback modes.

Disc formats such as Blu-ray Disc and DVD, as well as being supported by digital broadcasting, and even by streaming movies and music from internet-based subscription services.

This unit supports playback of almost all of these multi-channel audio formats. It also supports surround playback of audio formats other than multi-channel audio such as 2-channel stereo audio.



- For audio formats recorded on a disc, see the disc jacket or label.

■ Selecting a sound mode

1 Press MOVIE or MUSIC to select a sound mode.

When the button is pressed, the status LED blinks in blue, and the sound mode switches.

MOVIE:	Switches to the sound mode suitable for enjoying movies and TV programs.
MUSIC:	Switches to the sound mode suitable for enjoying music.



- If you use the HEOS App, you can manually select your favorite sound mode from multiple options. Refer to “Sound mode that can be selected for each input signal” (🔗 p. 54) for sound modes that can be selected.
- The MOVIE and MUSIC button memorizes the last sound mode selected for its button. Pressing MOVIE or MUSIC recalls the same sound mode as the one selected at the previous playback.
- If the content played back does not support the previously selected sound mode, the most appropriate sound mode for the content is automatically selected.

■ Pure mode playback

Enjoy sound that is faithful to the original source.

1 Press PURE.

When the button is pressed, the status LED blinks in blue, and sound mode switches to “Pure”.



- During pure mode playback, night mode and dialogue mode cannot be used. Each of these settings is disabled.



■ Description of sound mode types

Dolby sound mode

Sound mode type	Description
Dolby Atmos	Please select this mode to play content encoded with Dolby Atmos. In Dolby Atmos playback, the Dolby Speaker Virtualizer function operates automatically, and 3D playback is performed.
Dolby Atmos (Movie)*	Dolby Atmos playback is performed using Dolby technology exclusively. This mode is optimal for enjoying movies.
Dolby Audio - Dolby Surround	This mode uses Dolby Surround with Dolby virtual height and virtual surround sound processing to realize a three dimensional sound field.
Dolby Audio - Dolby Surround (Movie)*	Dolby Surround playback is performed using Dolby technology exclusively. This mode is optimal for enjoying movies.

* Night mode and dialog enhancer cannot be used. Each of these settings is disabled.

DTS sound mode

Sound mode type	Description
DTS:X / DTS:X Master Audio	This mode can be selected only when the input signal is DTS:X. In DTS:X playback, the Virtual:X function operates automatically, and 3D playback is performed.
DTS Virtual:X	This mode uses DTS Virtual:X with virtual height and virtual surround processing to realize a three-dimensional sound field.



PCM multi-channel sound mode

Sound mode type	Description
Multi PCM	This mode can be selected for playback of PCM signals that are input in certain transmission formats.

Stereo sound mode

Sound mode type	Description
Stereo	This mode performs stereo playback of a 2-channel signal without performing virtual processing. This mode can be selected for 2-channel signal input.

Direct sound mode

Sound mode type	Description
Direct	This mode performs playback of a multi-channel signal without performing virtual processing. This mode can be selected for multi-channel signal input.

Pure sound mode

Sound mode type	Description
Pure*	Enjoy sound that is faithful to the original source.

* Night mode and dialog enhancer cannot be used. Each of these settings is disabled.

Original sound mode

Sound mode type	Description
Multi-Channel Stereo*	This mode is for enjoying stereo sound from all speakers.

* This mode can be selected only when your HEOS built-in speakers are wirelessly connected as surround speakers. (🔗 p. 58)



■ Sound mode that can be selected for each input signal

The following sound modes can be selected with the MOVIE button, MUSIC button or PURE button.

○:Sound mode that can be selected when MOVIE button, MUSIC button or PURE button is pressed (●:Default sound mode)

Input signal	Sound mode	MOVIE button	MUSIC button	PURE button
2-channel	Stereo		<input type="radio"/>	
	Pure			<input type="radio"/>
	Dolby Surround	<input checked="" type="radio"/> *1		
	Dolby Surround (Movie)	<input type="radio"/> *2		
	DTS Virtual:X	<input checked="" type="radio"/> *1		
	Multi-Channel Stereo			<input type="radio"/> *3
Multi-channel	Direct		<input type="radio"/>	
	Pure			<input type="radio"/>
	Dolby Surround	<input checked="" type="radio"/> *1		
	Dolby Surround (Movie)	<input type="radio"/> *2		
	DTS Virtual:X	<input checked="" type="radio"/> *1		
	Multi-Channel Stereo			<input type="radio"/> *3
Dolby Atmos	Direct		<input type="radio"/>	
	Pure			<input type="radio"/>
	Dolby Atmos	<input checked="" type="radio"/>		
	Dolby Atmos (Movie)	<input type="radio"/>		
	Multi-Channel Stereo			<input type="radio"/> *3



Input signal	Sound mode	MOVIE button	MUSIC button	PURE button
DTS:X / DTS:X Master Audio	Direct		<input type="radio"/>	
	Pure			<input type="radio"/>
	DTS:X / DTS:X Master Audio	<input checked="" type="radio"/>		
	Multi-Channel Stereo		<input type="radio"/> *3	

*1 The default sound mode for Dolby and PCM input signals is Dolby Surround, and the default sound mode for DTS input signals is DTS Virtual:X.

*2 Dolby Surround (Movie) can be selected when the input signal is a Dolby signal.

*3 This mode can be selected only when your HEOS built-in speakers are wirelessly connected as surround speakers. (🔗 p. 58)



- If you use the HEOS App, you can select any sound mode that supports the input signal.
- If Dolby Surround or DTS Virtual: X is the last sound mode selected on the HEOS App, the sound mode that can be selected with the MOVIE button on the remote control unit switches to the last one selected on the HEOS App (Dolby Surround or DTS Virtual: X).



Quick select function

Input source, volume level, sound mode, night mode and dialog enhancer settings can be registered to the QUICK SELECT buttons.

1 Press and hold down one of the QUICK SELECT buttons (1 - 3) for 3 seconds.

The current settings are registered to the selected button.



- The status LED flashes once when registration is complete.
- To recall the registered settings, press the QUICK SELECT button.

[Default settings]

Button	Input source	Volume	Sound mode	Night mode	Dialog enhancer
Quick Select 1	TV	35	For Dolby audio signal input: Dolby Surround For DTS audio signal input: DTS Virtual:X For other audio signal input: Dolby Surround	Off	Off
Quick Select 2	HDMI IN	35		Off	Off
Quick Select 3	OPTICAL	35		Off	Off
Quick Select 4*	AUX	35	Stereo	Off	Off
Quick Select 5*	–	–	–	–	–
Quick Select 6*	–	–	–	–	–

* Registration and calling of Quick Select 4-6 can only be performed on the HEOS App. Download the HEOS App in advance to your iOS or Android device. (📖 p. 31)



- In the default state, Quick Select 5 and 6 are not set. Your own settings can be registered and used.



Operating this unit using the remote control of a TV

There are three ways to operate this unit using the remote control of a TV.

• HDMI control function

Connect this unit to a TV that supports the HDMI control function with an HDMI cable and enable the HDMI control setting on the TV to perform basic operations on this unit (changing the input source, turning the power on and off, adjusting the volume) with the remote control of the TV.

Refer to “HDMI control function” for more information about the HDMI control function. (📖 p. 71)

• Remote control preset function

This unit is preset such that you can adjust the volume using the volume adjustment button on the remote controls for the televisions of major manufacturers. This is useful when the television you are using does not support HDMI control, or when you connect to a television that does not have an HDMI connector.

• Remote control learning function

If your TV does not support the HDMI control function and Remote control preset function, use this unit’s remote control learning function. This enables you to operate this unit with the remote control of a TV. (“Using the remote control learning function” (📖 p. 57))

■ Using the remote control learning function

Perform this operation on the HEOS App. Download the HEOS App in advance to your iOS or Android device. (📖 p. 31)

- 1 Tap the Settings icon  located in the upper left corner of the main “Music” menu.**
The setting menu screen is displayed.
- 2 Select “My Devices” to display a list of your HEOS built-in devices.**
- 3 Select this unit.**
- 4 Select “Remote Control”.**
The setup below is not required when device control by HDMI is active. (A check mark will be displayed by “HDMI CEC” in this case)
- 5 Select “IR Control”.**
- 6 Select a command of this unit you would like to control by the remote control of your TV.**
Follow the instructions on the screen to complete setup.



Wirelessly connecting the HEOS built-in speakers as surround speakers

You can use your own HEOS built-in speakers and subwoofer to create a multi-channel surround system.

Perform this operation on the HEOS App. Download the HEOS App in advance to your iOS or Android device. (👉 p. 31)

1 Tap the Settings icon located in the upper left corner of the main “Music” menu.

The setting menu screen is displayed.

2 Select “My Devices” to display a list of your HEOS built-in devices.

3 Select this unit.

4 Select “Setup Assistant”.

The setup assistant menu screen is displayed.



- A HEOS built-in subwoofer and surround speakers need to connect your wireless network beforehand.

■ Connecting the HEOS built-in subwoofer

1 Select “Subwoofer”.

2 Follow the instructions on the HEOS App to connect the HEOS built-in subwoofer.



- Configure the HEOS built-in subwoofer settings after connecting is complete. Select “Optimized for Denon Home Sound Bar 550” for normal configuration. Settings are optimized for this unit.

■ Connecting the HEOS built-in surround speakers

1 Select “Surrounds”.

2 Follow the instructions on the HEOS App to connect the HEOS built-in speaker or HEOS Amp.

Select the device that you want to add and tap “Next”.



■ Disconnecting HEOS built-in subwoofer and surround speakers

- 1** Tap the pencil  icon in the upper right from the “Rooms” menu.
- 2** Select this unit.
- 3** Select the device that you want to disconnect from the list.

Operating this unit by voice with the Amazon Alexa function

NOTE

- Optional Alexa Built-in functionality will become available via a future firmware update.



With the Amazon Alexa built into this unit, you can enjoy the ability to operate the unit and play music simply by speaking.

To use Alexa, the unit must be connected to the network. An Amazon account is also required.

Download the HEOS App in advance to your iOS or Android device and then connect this unit to the network. (📖 p. 31)

Next, use the HEOS App to enter your Amazon account information and log in to the service.



- In cases such as when you want to prevent accidental activation of Alexa or you want to protect your privacy, touch the  key on this unit to disable the microphone.
- Instead of saying “Alexa”, you can also touch the  key on this unit to initiate voice control using Alexa.
- Alexa isn’t available in certain languages and countries.





Examples of voice operation

For example, ask Alexa the following:

- Alexa, play music
- Alexa, pause
- Alexa, turn up the volume

Example of light bar display

The light bar on the front panel of the unit lights up according to the status of Alexa.

Status of Alexa (examples)	Light bar display
While on standby	
When starting up	 (The LED light moves from both sides to the center in light-blue, and then the entire light bar lights in blue)
While the microphone is muted	 (Lights in red)

Setting the input source to switch with the TV button on the remote control unit

In the default settings, pressing the TV button switches to the audio input from the HDMI OUT (eARC/ARC) connector.

If you use the HEOS App, you can change the input source that is switched to when the TV button is pressed.

- 1 Tap the **Settings icon**  located in the upper left corner of the main “Music” menu. The setting menu screen is displayed.
- 2 Select “My Devices” to display a list of your HEOS built-in devices.
- 3 Select this unit.
- 4 Select “TV Input”.
- 5 Select “Default Input”.
- 6 Select an Input source you connect to your TV audio.



Troubleshooting

If a problem should arise, first check the following:

1. **Are the connections correct?**
2. **Is the set being operated as described in the owner's manual?**
3. **Are the other devices operating properly?**

If this unit does not operate properly, check the corresponding symptoms in this section.

If the symptoms do not match any of those described here, consult your dealer as it could be due to a fault in this unit. In this case, disconnect the power immediately and contact the store where you purchased this unit.



Power does not turn on / Power is turned off

Power does not turn on.

- Check whether the power plug is correctly inserted into the power outlet. (👉 p. 26)
- If the power of this unit cannot be turned on with the remote control for the TV, press the ⏻ button to turn on the power of this unit. (👉 p. 27)
- Enable the TV's HDMI control function when using an HDMI cable to connect this unit to your HDMI control-compatible TV. (See the TV owner's manual for details.)

Power automatically turns off.

- If no operations have been performed for 20 minutes or more and audio is not being input, this unit automatically switches to quick start mode. Turn this unit's power on again. (👉 p. 72)

Operations cannot be performed through the remote control unit

Operations cannot be performed through the remote control unit.

- Battery is worn out. Replace with new battery. (👉 p. 11)
- Operate the remote control unit within a distance of about 23 ft/7 m from this unit and at an angle of within 30°. (👉 p. 12)
- Remove any obstacle between this unit and the remote control unit.
- The coin-shaped lithium battery (CR2025) is not positioned correctly. Correct the positioning so that the ⊕ symbol engraved on the battery faces upwards. (👉 p. 11)
- This unit's remote control sensor is exposed to strong light (direct sunlight, inverter type fluorescent bulb light, etc.). Move this unit to a place in which the remote control sensor will not be exposed to strong light.



Trouble teaching this unit remote control commands

Trouble teaching this unit remote control commands.

- Remember that while this unit can learn almost all IR (infrared) remote commands, there remain a few rare code formats that cannot be taught.

No sound comes out

No sound comes out.

- Check the connections for all devices. (👉 p. 21)
- Insert connection cables all the way in.
- Check that input connectors and output connectors are not reversely connected.
- Check cables for damage.
- Check that a proper input source is selected. (👉 p. 27)
- Adjust the volume. (👉 p. 28)
- Make sure volume is not muted. (👉 p. 28)



Music cuts out or delays sometimes

Music cuts out or delays sometimes.

- Make sure your Internet connection is operating correctly. If you are sharing your network with other users or devices, they may be using most of your bandwidth (especially if they are streaming video).
- Make sure this unit is within range of your wireless network.
- Make sure this unit is not located near other electronic devices that could interfere with its wireless connectivity (like microwave ovens, cordless phones, TVs, etc...).

The HDMI Control function does not work

The HDMI Control function does not work.

- You cannot operate devices that are not compatible with the HDMI Control function. In addition, depending on the connected device or the settings, the HDMI Control function may not work. In this case, operate the external device directly.
- Check that the HDMI Control function setting is enabled on all devices connected to this unit.

Audio can be heard coming from the TV's speakers

Audio can be heard coming from the TV's speakers.

- Disable the TV's speakers (usually a setup-menu option, but a rear-panel switch on some TVs).



I hear a delay when using the external input with my TV

I hear a delay when using the external input with my TV.

- If you are connecting the external input with your cable or satellite box for enjoying TV audio through multiple HEOS built-in devices, you may hear a delay between when you see someone speak and when you hear the audio. This is because the HEOS system must buffer the audio before it sends it out to the HEOS built-in devices so that it arrives at all devices at the same time. You can avoid this delay by listening only to the device which is directly connected to the set top box.

Bluetooth playback does not work

Cannot pair with a Bluetooth device.

- It may be that Bluetooth is not enabled on the Bluetooth device. See the owner's manual of the Bluetooth device to enable the Bluetooth function.
- This unit may be paired with another Bluetooth device. Select this unit from the list of devices displayed on the screen of the Bluetooth device.
- Bring the Bluetooth device near to this unit.
- Turn the power of the Bluetooth device off and on again, and then try again.
- Only 1 Bluetooth device can be connected at a time.
- The connection from the Bluetooth mobile device is malfunctioning. Power cycle the mobile device, remove the pairing information and re-pair this unit to the mobile device.

The sound is cut off.

- Bring the Bluetooth device near to this unit.
- Remove obstructions between the Bluetooth device and this unit.
- To prevent electromagnetic interference, locate this unit away from microwave ovens, wireless LAN devices and other Bluetooth devices.
- Pair with the Bluetooth device again. (👉 p. 29)



Cannot connect the sound bar to the network

Cannot connect the sound bar to the network.

- Make sure your mobile device is connected to your wireless network before setting up your sound bar. (🔍 p. 32)
- You can connect your sound bar to your network router using an Ethernet cable sold separately. Once connected via Ethernet, the HEOS App should recognize the sound bar and you can manually move it to your wireless network using “Settings” - “My Devices” - (“Device Name”) - “Advanced” - “NETWORK SETTINGS”. (🔍 p. 33)

Connecting to a network using an iOS device

Connecting to a network using an iOS device.

- This unit supports Apple’s “WAC (Wireless Accessory Configuration)” setup mode. WAC setup mode allows you to connect this unit to your network without requiring you to type in the network name and password.
 1. The CONNECT LED on the rear of this unit will slowly blink amber to indicate that WAC setup mode is active. If the rear LED is not blinking amber, press and hold volume down (-) and ► / || button on the sound bar for 3 seconds until you see the LED blinking amber.
 2. Go to the Wi-Fi menu under Settings on your iOS device.
 3. Select “Denon Home Sound Bar 550” under “SET UP NEW AIRPLAY SPEAKER...” at the bottom of the list.
 4. Select the network you want this unit to connect to and select “Next”.
 5. Follow the instructions on the screen to complete setup.
 6. When the connection is complete, the status LED on the front of this unit will turn solid blue.
- This unit will stay in WAC setup mode for 15 minutes. If this unit is not setup within 15 minutes, it will revert back to its previous network connection. Press the ► / || button on the sound bar if you want to cancel WAC setup mode.



Connecting to a WPS network

Connecting to a WPS network.

- If your wireless router support WPS (Wi-Fi Protected Setup™) this unit can optionally connect to your network using the push button method by following these steps:
(Wi-Fi Protected Setup™ is trademarks of Wi-Fi Alliance.)
 1. Press the WPS button on your router.
 2. Within 2 minutes, press and hold the CONNECT button on the rear panel of the sound bar for 3 seconds.
 3. The status LED on the front of the sound bar will flash green for several seconds as it connects to your WPS router.
 4. When the connection is complete, the status LED on the front of the sound bar will turn solid green.

This unit takes long time to turn on

This unit takes long time to turn on.

- In case this unit as in the deep standby mode, it may takes around 40 second to turn on.



Cannot operate the unit with Alexa

Alexa is not configured correctly.

- Download the HEOS App to your iOS or Android device, and use the HEOS App to configure the settings correctly. (👉 p. 31)

The unit is not connected to the network.

- Download the HEOS App to your iOS or Android device, and use the HEOS App to connect to the network. (👉 p. 31)

NOTE

- Optional Alexa Built-in functionality will become available via a future firmware update.

Alexa does not respond even if called

The microphone is disabled.

- Touch the  key to enable the microphone.

NOTE

- Optional Alexa Built-in functionality will become available via a future firmware update.





Resetting factory settings

When the network function or this unit do not operate correctly, the problem may be solved by resetting factory settings.

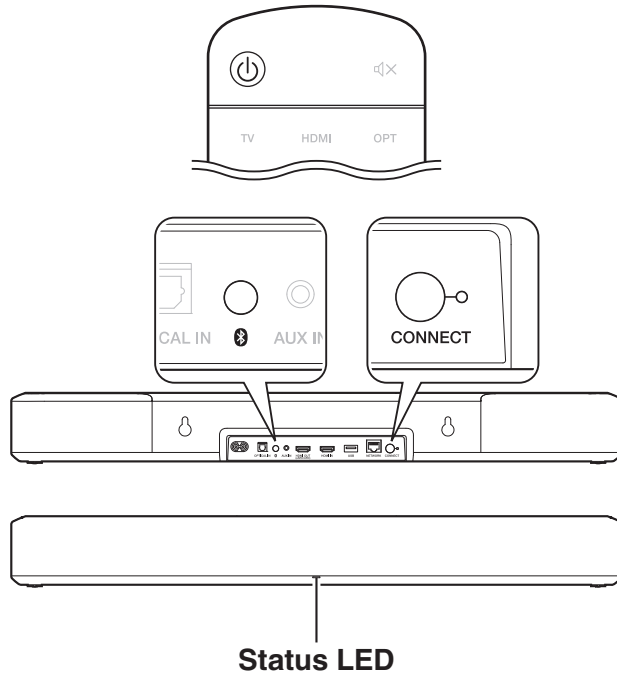
Resetting this unit will clear out the wireless network info, EQ, and name but retain its current software. You will have to use “Settings” - “Add Device” from the HEOS App to reconnect this unit to your home network before it can be used.



- 1** Press  to turn on power to the unit.
- 2** Press and hold the **CONNECT** and  buttons on the sound bar for 5 seconds.

The status LED blinks in amber and initiates a reset.





Resetting the firmware to the default state

When the network function or this unit do not operate correctly, the problem may be solved by resetting the firmware to the default state.

- It is confirmed that the network connection has no problem, but the unit cannot connect to the Internet.
- The solution described in “Resetting factory settings” does not work. (👉 p. 69)

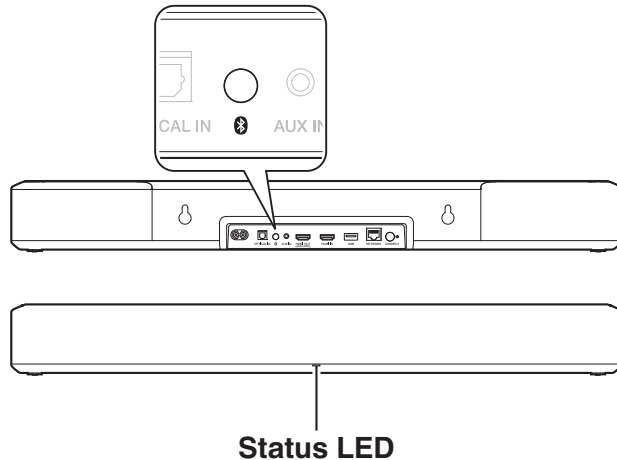
For such cases, perform the following operation:



- 1 Unplug the power cord from the power outlet.**
- 2 Plug in the power cord while holding down the  button.**
- 3 Release the button after the status LED starts to blink in amber.**

When the status LED switches from blinking amber to solid, the recovery process is complete.



- Since this process includes a firmware recovery, it takes some time to complete.
- This process will clear out all the information that you set.
- Do not unplug the power cord until the entire process completes.
- If the problem is not solved after performing this operation, contact our customer service center.



About HDMI

This unit supports the following HDMI functions.

- **ARC (Audio Return Channel) function**

Enjoy movies, music, etc., on your TV simply by connecting an ARC function-compatible TV to this unit via HDMI.

- **eARC (Enhanced Audio Return Channel) function**

The eARC function is compatible with conventional ARC function compatible audio formats in addition to multichannel linear PCM, Dolby TrueHD, Dolby Atmos, DTS-HD Master Audio, DTS:X and other audio formats a conventional ARC function cannot transmit. Additionally, connecting to an eARC function-compatible TV enables enjoyment of higher-quality surround playback of the audio content played from your TV.

- **HDMI control function**

Connect an HDMI control-compatible TV and this unit via HDMI and enable the HDMI control to enable linked control from either device.

- Input source switching

If the TV is turned on, this unit automatically powers on and switches the input source.

- Power off link

The TV power off operation is linked so this unit also turns off.

- Volume adjustment

The volume of this unit can be adjusted using the TV remote control.

- Audio output destination switching

If this unit is turned on, TV audio is output from this unit. If this unit is turned off, TV audio is output from the speakers of the TV.



- Some functions may not operate depending on the connected TV.



Power management

Power modes

■ Quick start mode

This unit automatically enters quick start mode to save power in the following cases. During quick start mode, this unit operations cause the power to turn on.

During quick start mode, the status LED lights in dim blue or dim amber.

❑ Ethernet

After around 20 minutes of no operation and no network access after playing music via Ethernet.

❑ Wi-Fi

After around 20 minutes of no operation and no network access after playing music via Wi-Fi.

❑ USB

After around 20 minutes of no operation and no network access after playing music from a USB flash drive.

❑ Bluetooth

After the Bluetooth connection is disconnected and there is around 20 minutes of no operation and no network access after playing music via Bluetooth.

❑ AUX input

After around 20 minutes of no audio.

❑ Optical input

After around 20 minutes of no operation after optical device is put into standby.

❑ HDMI input

Play the HDMI device, such as a Blu-ray player, connected to this unit. Around 20 minutes after HDMI device and TV are put into standby.

❑ HDMI output (eARC/ARC)

Connect this unit and the eARC/ARC compatible TV with HDMI cable and play TV. Around 20 minutes after TV is put into standby.



- You also press the  button on the remote control unit to switch to quick start mode.





■ Deep Standby

The device also has the ability to automatically enter “Deep Standby” whenever the wired or wireless network connection is removed for more than 60 minutes in quick start mode.

The front panel LED will turn off during Deep Standby. To wake this unit from Deep Standby,

- Press any button on the sound bar or the included remote control unit.
- Input audio signal to Optical.
- CEC (Consumer Electronics Control) command over HDMI/ARC
- Use a TV remote control that has learned the operations of this unit with the remote control learning function to operate this unit.
( p. 57)



- It may take around 40 seconds to wake up this unit from the deep standby.
- You also press the  button on the remote control unit for 5 seconds, the device enters the deep standby.
- You also press the  key for 5 seconds, the device enters the deep standby.

■ Off

To completely turn off the power to the device you must remove the mains plug from the power outlet.



Status LED table

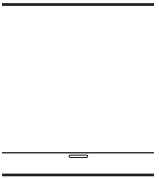
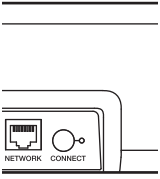
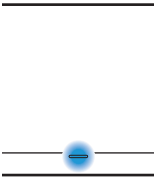
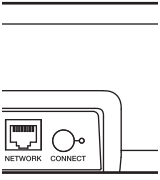
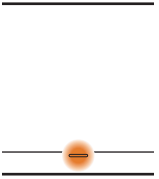
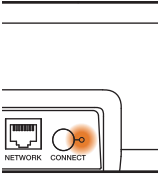

The LEDs on the front panel and rear panel change to indicate the current sound bar status.

Status	Front LED action	Rear LED action	Description
Deep standby mode	 (off)	 (off)	Power is off, or the sound bar is in deep standby mode. (👉 p. 73)
Quick start mode	 (dimmed solid)	 (off)	Sound bar is in quick start mode (Connected to your network). (👉 p. 72)
	 (dimmed solid)	 (dimmed solid)	Sound bar is in quick start mode (Not connected to your network). (👉 p. 72)

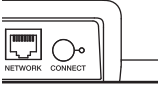
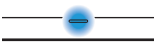
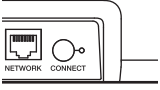
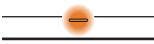
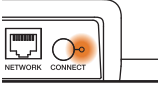



Status	Front LED action	Rear LED action	Description
Power on	 (blink)	 (off)	Sound bar is starting up or connecting to the network.
	 (solid)	 (off)	Sound bar is connected to the network.
	 (solid)	 (solid)	Sound bar is unable to connect to the network. Try to connect the sound bar again.

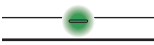
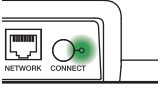
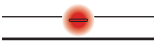
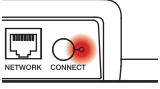

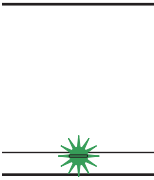
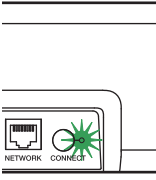

Status	Front LED action	Rear LED action	Description
WPS	 <p>(fast blink)</p>	 <p>(fast blink)</p>	Sound bar is connecting to the network via WPS.
	 <p>(for 3 sec. solid)</p>	 <p>(solid)</p>	Sound bar is connected to the network via WPS.
	 <p>(for 3 sec. solid)</p>	 <p>(solid)</p>	WPS has timed out.

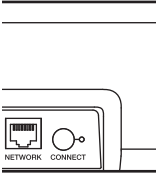
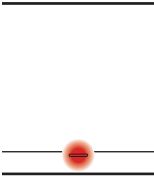
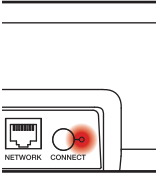

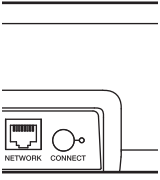

Status	Front LED action	Rear LED action	Description
Bluetooth	 <p>(two blinks)</p>	 <p>(two blinks)</p>	Sound bar is pairing via Bluetooth.
	 <p>(one blink)</p>	 <p>(off)</p>	Sound bar is paired via Bluetooth.
	 <p>(for 3 sec. solid)</p>	 <p>(for 3 sec. solid)</p>	Sound bar failed to pair to the Bluetooth device. Try to pair again. (👉 p. 29)

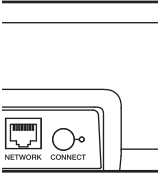



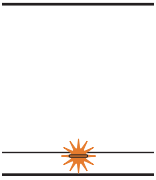

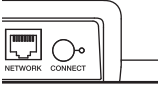

Status	Front LED action	Rear LED action	Description
Volume setting	 <p>(quick blink)</p>	 <p>(off)</p>	Volume is being adjusted.
	 <p>(slow blink)</p>	 <p>(off)</p>	Sound bar is muted.



Status	Front LED action	Rear LED action	Description
Firmware update	 (blink)	 (blink)	Firmware is being updated.
	 (slow blink (Not fade))	 (off)	There is a firmware error. Check your usage environment, relaunch the app, then try to update the firmware again.



Status	Front LED action	Rear LED action	Description
Error	 (solid)	 (solid)	There was a setup error. Check your usage environment, then follow the correct procedure to try setup again. If the error occurs again, restore factory settings and try setup again. (☞ p. 69)
	 (fast blink)	 (off)	There is a hardware error. Unplug the power cord, wait a little while, then plug the power cord back in.
Reset	 (fast blink)	 (solid)	Factory settings have been restored.



Supported file types and codecs

Frequency	Sample rate	File extension	Codec	Bit rates
32/44.1/48/88.2/96/176.4/192 kHz	16/24 bit	.wav	PCM	–
32/44.1/48 kHz	16 bit	.mp3	MPEG-1 Audio Layer 3 CBR/VBR	32 - 320 kbps
32/44.1/48 kHz	16 bit	.aac/.m4a	AAC-LC	48 - 320 kbps
32/44.1/48 kHz	16 bit	.wma	wma9 CBR	CBR:48 - 192 kbps
44.1/48/88.2/96/176.4/192 kHz	16/24 bit	.flac	flac	–
44.1/48/88.2/96/176.4/192 kHz	16/24 bit	.m4a	ALAC	–
2.8/5.6 MHz	1 bit	.dff/.dsf	DSDIFF DSF	–



- For USB memory, the limited numbers of folders and files that can be played back on this unit are as follows.
 - Number of folder directory levels:8 levels (The limited number includes the root folder.)
 - Number of folders:500
 - Number of files:5000 (The allowable number of files may differ according to the USB flash drive capacity and the file size.)
- Files protected by DRM such as Apple's Fairplay DRM, are not supported.
- The Apple Lossless Audio Codec (ALAC) decoder is distributed under the Apache License, Version 2.0 (<http://www.apache.org/licenses/LICENSE-2.0>).

Supported audio formats (Optical)

2-channel Linear PCM:2-channel, 32 kHz – 96 kHz, 16/20/24 bit

Bitstream:Dolby Digital, DTS



Trademark information

COMPATIBLE WITH

 **Dolby Vision**  **Dolby Atmos**

Dolby, Dolby Vision, Dolby Atmos, and the double-D symbol are registered trademarks of Dolby Laboratories Licensing Corporation. Manufactured under license from Dolby Laboratories. Confidential unpublished works. Copyright © 2012–2020 Dolby Laboratories. All rights reserved.



For DTS patents, see <http://patents.dts.com>. Manufactured under license from DTS, Inc. DTS, DTS:X, Virtual:X, and the DTS:X logo are registered trademarks or trademarks of DTS, Inc. in the United States and other countries. © 2020 DTS, Inc. ALL RIGHTS RESERVED.

HIGH DEFINITION MULTIMEDIA INTERFACE

The terms HDMI, HDMI High-Definition Multimedia Interface, and the HDMI Logo are trademarks or registered trademarks of HDMI Licensing Administrator, Inc.



Apple, AirPlay, iPad, iPad Air, iPad Pro and iPhone are trademarks of Apple Inc., registered in the U.S. and other countries.

The trademark “iPhone” is used in Japan with a license from Aiphone K.K.

Use of the Works with Apple badge means that an accessory has been designed to work specifically with the technology identified in the badge and has been certified by the developer to meet Apple performance standards.





The Wi-Fi CERTIFIED logo is a registered trademark of the Wi-Fi Alliance.

Wi-Fi Certification provides assurance that the device has passed the interoperability test conducted by the Wi-Fi Alliance, a group that certifies interoperability among wireless LAN devices.



The Bluetooth® word mark and logos are registered trademarks owned by the Bluetooth SIG, Inc. and any use of such marks by D&M Holdings Inc. is under license. Other trademarks and trade names are those of their respective owners.



Roku TV, Roku TV Ready, and the Roku TV Ready logo are trademarks of Roku, Inc.



Specifications

Sound bar

■ General

Operating temperature:	41 °F - 95 °F (5 °C - 35 °C)
Power supply:	AC 100 – 240 V, 50/60 Hz (for Europe model) AC 100 – 120 V, 50/60 Hz (for North America model)
Power consumption:	53 W 21 W (USB/1 A)
Power consumption in quick start mode:	7.4 W (HDMI IN) 7.0 W (Wi-Fi) 7.2 W (Ethernet) 7.4 W (Bluetooth) 7.7 W (HDMI OUT(ARC))
Power consumption in deep standby mode:	0.4 W
Max analog input:	2 Vrms



■ Wireless LAN section

Network type (wireless LAN standard):	Conforming to IEEE 802.11a/b/g/n/ac (Wi-Fi® compliant)*1
Used frequency range:	2.4 GHz, 5 GHz

*1 The Wi-Fi® CERTIFIED Logo and the Wi-Fi CERTIFIED On-Product Logo are registered trademarks of the Wi-Fi Alliance.

■ Bluetooth section

Communications system:	Bluetooth Version 4.2
Transmission power:	Power Class 2
Maximum communication range:	Approx. 32.8 ft/10 m in line of sight*2
Used frequency range:	2.4 GHz band
Modulation scheme:	FHSS (Frequency-Hopping Spread Spectrum)
Supported profiles:	A2DP (Advanced Audio Distribution Profile) 1.3 AVRCP (Audio Video Remote Control Profile) 1.6
Corresponding codec:	SBC
Transmission range (A2DP):	20 Hz – 20,000 Hz

*2 The actual communication range varies depending on the influence of such factors as obstructions between devices, electromagnetic waves from microwave ovens, static electricity, cordless phones, reception sensitivity, antenna performance, operating system, application software etc.

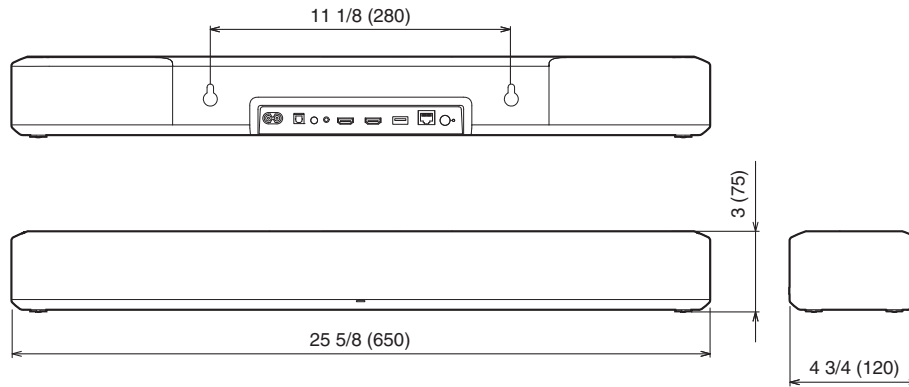

■ Dimensions (Unit : in. (mm))**■ Weight : 7 lbs 11 oz (3.5 kg)**

Licence

This unit uses source code programmed under GPL or LGPL.

The licenses used are listed in the WEB manual.

<http://manuals.denon.com/DenonHomeSB550/EU/EN/>



DENON[®]

www.denon.com

3520 10797 00ADB

©2020 Sound United. All Rights Reserved.