

DENON[®]

DENON HOME 150

ALTAVOCES INALÁMBRICOS

Manual del usuario



Introducción	5	Instrucciones de uso del altavoz	16
Antes de comenzar	6	Selección de una habitación o un altavoz	16
Requisitos del sistema	6	Función de selección rápida	17
Requisitos de red	6	Cómo escuchar la radio	18
Presentación de su altavoz	7	Reproducción de música almacenada en un dispositivo móvil	18
Panel delantero	8	Reproducción de música del PC o un dispositivo de almacenamiento conectado a la red	19
Panel superior	9	Reproducción de música de la entrada AUX	20
Panel trasero	10	Reproducción de música de un dispositivo de memoria USB	21
Colocación del altavoz	11	Reproducción de música de un dispositivo Bluetooth	22
Montaje en pared o en el techo	11	Emparejamiento del altavoz con sus dispositivos Bluetooth	22
Alimentación de su altavoz	12	Cuenta HEOS	23
Obtención de la aplicación HEOS	13	¿En qué consiste una cuenta de HEOS?	23
Configuración de su primer altavoz	14	¿Por qué necesito una cuenta de HEOS?	23
Añadir más altavoces	15	Registro en una cuenta de HEOS	23
Cómo agregar altavoces con cable	15	Cambiar su cuenta HEOS	23
Añadir altavoces inalámbricos	15	Reproducción de servicios de transmisión de música	24
		Cómo agregar un servicio de música	24
		Cambio de los ajustes del servicio de música	24
		Administración de entradas	25
		Cambio del nombre de las entradas	25
		Ocultar una entrada	25
		Administración de su teléfono	26



Cómo escuchar la misma música en varias habitaciones	27
Agrupación de habitaciones	27
Eliminación de una agrupación de habitaciones	28
Agrupación de todas las habitaciones (modo de fiesta)	29
Eliminación de la agrupación de todas las habitaciones	30
Emparejamiento estéreo	31
Creación de un par estéreo	31
Cambio del nombre de un par estéreo	33
Ajuste del Balance	33
Intercambio de los canales izquierdo y derecho en un par estéreo	34
Eliminación de un par estéreo	34
Uso de la cola de reproducción	35
Reproducir ahora	35
Reproducir & Reemplazar la cola	35
Reproducir siguiente	35
Agregar al final de la cola	35
Reorganización de la cola de reproducción	36
Eliminación de canciones de la cola de reproducción	36
Eliminación de todas las canciones de la cola de reproducción	37
Almacenamiento de listas de reproducción	37
Realización de las funciones de repetición y reproducción de forma aleatoria	37
Uso de los favoritos	38
Añadir a los favoritos de HEOS	38
Eliminar una emisora de los favoritos de HEOS	38

Función de AirPlay	39
Reproducción de canciones desde su iPhone, iPod touch o iPad	40
Reproducción de música de iTunes con su altavoz	40
Reproduzca una canción desde su iPhone, iPod touch o iPad en múltiples dispositivos sincronizados (AirPlay 2)	41
Configuración de los ajustes del altavoz	42
Cambio del nombre de un altavoz	42
Cambio de la conexión de red inalámbrica	42
Cambio del ecualizador del altavoz	43
Ajuste de la calidad de audio	43
Ajuste de la luminosidad de la luz de estado	43
Configuración avanzada del altavoz	44
Ajustes de red	44
Acerca del ahorro de energía en modo inalámbrico	44
Actualización de firmware	45
Acerca de	45



Actualización del sistema	46	Cuadro de LED de estado	55
Funciones avanzadas	47	Codecs y tipos de archivo compatibles	59
Intercambio de música de un dispositivo móvil	47	Especificaciones	60
Rendimiento inalámbrico	47	Información	62
Enviar diagnósticos	48	Marcas	62
Restablecimiento de la aplicación de controlador	48	Licencia	64
Gestión de alimentación	49	Información acerca de la licencia del software empleado en la unidad	64
Modos de alimentación	49		
Modo de inicio rápido	49		
Modo de espera completo	49		
Apagado	49		
Resolución de problemas básicos	50		
No es posible conectar el altavoz a la red	50		
No es posible emparejar un dispositivo móvil Bluetooth con el altavoz	50		
No puedo escuchar la música procedente de la conexión Bluetooth	51		
A veces la música se corta o se retrasa	51		
Escucho un retardo al utilizar la entrada AUX con mi TV	52		
Conexión a una red usando un dispositivo iOS	52		
Escucho distorsión cuando utilizo la entrada AUX	53		
Conexión a una red WPS	53		
Restaurar su altavoz	54		
Los botones no funcionan correctamente	54		



Le damos las gracias por la adquisición de este producto Denon. Para asegurar un funcionamiento correcto de la unidad, lea atentamente este manual del usuario antes de usarla.

NOTA

- Este documento contiene información sujeta a cambios sin previo aviso.

Introducción

El altavoz forma parte del sistema HEOS que le permite disfrutar de su música favorita en cualquier parte de la casa. Al utilizar su red doméstica existente y la aplicación HEOS en su dispositivo iOS o Android™, puede explorar, navegar y reproducir música de su propia biblioteca de música o de muchos servicios en línea de transmisión de música.

- Verdadero audio en varias habitaciones: reproduzca canciones diferentes en distintas habitaciones o la misma canción en todas las habitaciones
- Se emplea su red doméstica inalámbrica existente para gozar de una configuración rápida y sencilla
- Sincronización de audio en microsegundos entre altavoces líder en el sector
- La legendaria calidad de audio de Denon
- Si tiene prisa, puede disfrutar de su música con gran sonido en apenas tiempo si sigue los pasos que se indican en la guía de inicio rápido (incluida con su altavoz).

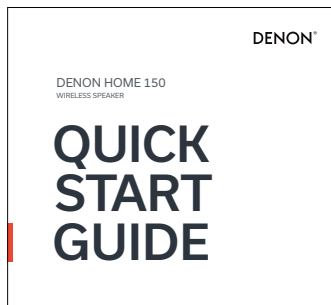

Siga leyendo este manual del usuario para obtener más información acerca de las funciones y ventajas de su altavoz.



Antes de comenzar

NOTA

- Si ya ha instalado al menos un altavoz, vaya directamente a la sección “Añadir más altavoces” (🏠 p. 15).

Requisitos del sistema

Antes de comenzar la instalación de su primer altavoz, asegúrese de conocer y satisfacer varios requisitos básicos.

■ Requisitos de red

Enrutador inalámbrico - Para poder utilizar su sistema HEOS, debe disponer de una red inalámbrica (Wi-Fi) o Ethernet en funcionamiento en su casa. Incluso cuando está conectado a una red Ethernet, para controlar el sistema utilizando la aplicación de HEOS es necesaria una conexión Wi-Fi al enrutador. Si no posee una red inalámbrica, póngase en contacto con un distribuidor de Denon local o con un distribuidor de productos electrónicos para que le ayude con la compra e instalación de una red inalámbrica doméstica.

Conexión a Internet de alta velocidad: el sistema HEOS accede a Internet para transmitir música en la casa desde distintos servicios populares de música en línea. El sistema HEOS también se ha diseñado para proporcionarle actualizaciones de software, que se envían a través de su conexión a Internet doméstica. Los servicios DSL, por cable y de fibra proporcionan la mejor experiencia y fiabilidad. Puede sufrir problemas de rendimiento con conexiones a Internet más lentas, como la de los servicios por satélite.



Presentación de su altavoz

Desempaque el altavoz de la caja y constate que se incluyen los elementos siguientes:

① Altavoz

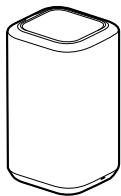

② Guía de inicio rápido



③ Instrucciones de seguridad



④ Nota sobre la radio



⑤ Garantía
(modelo norteamericano únicamente)

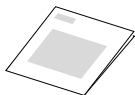

⑥ Cable de alimentación
(para modelos de Europa)

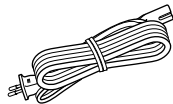

⑦ Cable de alimentación
(para modelos de Norteamérica)

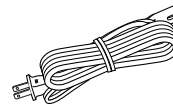

NOTA

- Por favor, use el cable de alimentación incluido en la caja de su dispositivo.



■ Panel delantero

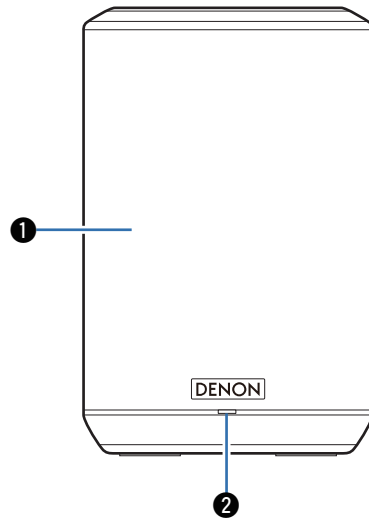

① Altavoces

② LED de estado

Consulte "Cuadro de LED de estado" para conocer el significado del estado y del color de LED. (📖 p. 55)



■ Panel superior

Mantenga la mano sobre la parte superior del altavoz para mostrar los botones del panel de operaciones. Toque estos botones para realizar operaciones. Alejar la mano del área ocultará los botones.

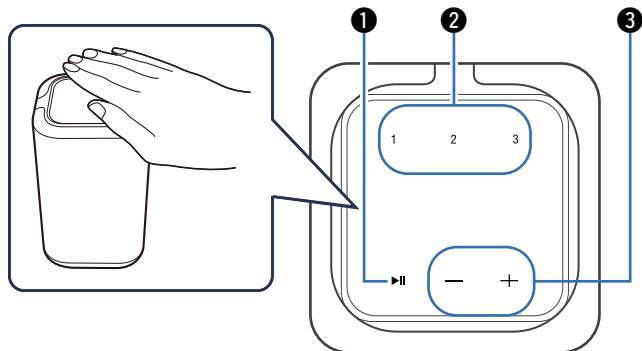

1 Botón de reproducción/pausa (▶||)

- Presione este botón para pausar la reproducción. Si lo presiona mientras está en pausa o detenida, reanudará la reproducción desde la última pista reproducida.
- Mantenga presionado el botón durante 5 segundos para entrar en modo de espera completo. (👉 p. 49)

2 Botones de selección rápida (1 - 3)

Registre los ajustes de la fuente de entrada en estos botones o recupere esos ajustes. (👉 p. 17)

3 Botones de volumen (+, -)

Ajustan el nivel de volumen.

NOTA

- No coloque ningún objeto sobre el producto. Hacerlo puede provocar operaciones accidentales.



■ Panel trasero

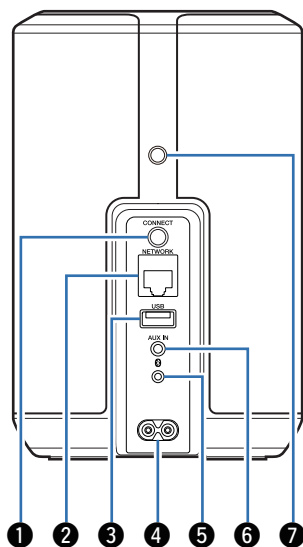

1 Botón CONNECT

Sirve para configurar la conexión Wi-Fi. (👉 p. 53)

2 Conector NETWORK

Sirve para conectar esta unidad a una red Ethernet con cable. (👉 p. 15)

3 Entrada USB

Sirve para conectar dispositivos de memoria USB. (👉 p. 21)

4 Entrada de CA

Se utiliza para conectar el cable de alimentación. (👉 p. 12)

5 Botón Bluetooth (📶)

Utilizado en la configuración del emparejamiento de Bluetooth. (👉 p. 22)

6 Conector de entrada AUX (AUX IN)

Sirve para conectar dispositivos de audio. (👉 p. 20)

7 Orificio del tornillo de montaje

Se utiliza al montar esta unidad en la pared o el techo. (👉 p. 11)



Colocación del altavoz

Puede colocar el altavoz donde le plazca para disfrutar de música de gran calidad. Siga estas sencillas instrucciones al decidir el lugar donde desee colocar el altavoz:

- El altavoz debe estar dentro del perímetro de alcance de la red inalámbrica.
- El altavoz se ha diseñado para proporcionar un sonido mejor cuando se coloca a una distancia de 3 a 12 pulgadas (8 a 30 cm) de una pared.
- Coloque el altavoz al menos a una distancia de 12 pulgadas (30 cm) de un televisor, ordenador u otro dispositivo con pantalla para evitar la posibilidad de que se produzcan interferencias.
- Coloque el altavoz en la habitación en la que lo escuchará, en la medida de lo posible a una altura similar a la del oído.
- El altavoz no es impermeable. No lo coloque cerca de una fuente de agua ni lo deje en el exterior si llueve o nieva.

■ Montaje en pared o en el techo

Este altavoz puede montarse en una pared o techo utilizando un montaje/accesorio de altavoz estándar o de cámara (diámetro de 1/4 pulgadas / 6,35 mm) que soporte al menos 14 libras, 16 onzas / 6,8 kg. Para obtener más información, contacte con el establecimiento donde adquirió el altavoz. Para obtener más información, contacte con el establecimiento donde adquirió el altavoz.

Precaución

- Utilice un soporte comercial (a la venta por separado) para fijar esta unidad a la pared o al techo. No la conecte directamente a la pared o al techo.
- Si conecta esta unidad a la pared o al techo, verifique que esté instalada de forma segura. Tenga en cuenta que Denon no asume responsabilidad alguna por ningún daño si la unidad sufriera alguna caída.



Alimentación de su altavoz

Conecte el cable de alimentación incluido en la caja en el panel posterior del altavoz y el enchufe a la toma de corriente de la pared. El altavoz es capaz de cambiar automáticamente entre 100 y 240 V.

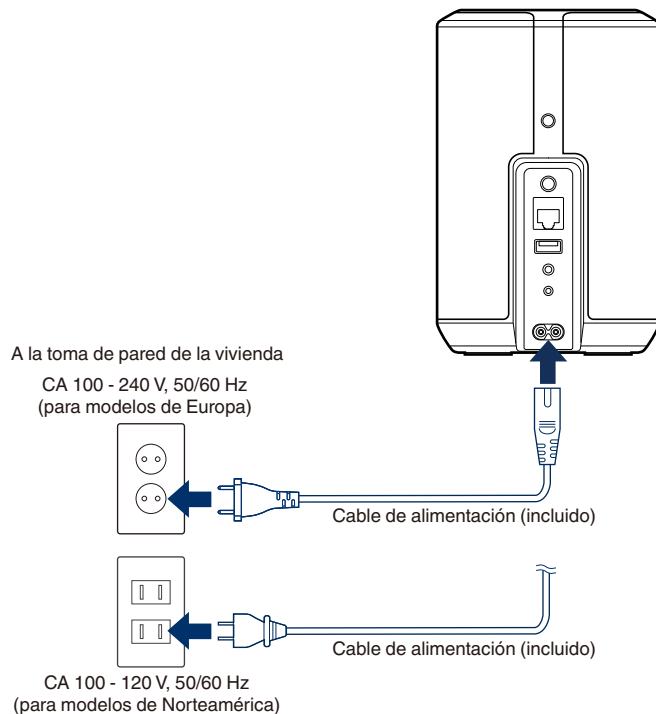

Obtención de la aplicación HEOS

La aplicación HEOS es el corazón de la experiencia del sistema HEOS. Mediante su dispositivo móvil y la aplicación HEOS, puede configurar, navegar, explorar y controlar su sistema HEOS desde la palma de su mano, desde cualquier lugar de su casa.

Busque "HEOS" en la App Store® o en Google Play™ o Amazon y descargue la aplicación HEOS para iOS o Android.



Con el propósito de introducir mejoras, las especificaciones y el diseño del equipo están sujetos a cambios sin previo aviso.



Configuración de su primer altavoz

Una vez haya colocado el altavoz en la habitación donde desee escuchar música y haya descargado la aplicación HEOS, podrá configurar el altavoz para la reproducción de música. Para conectar el altavoz a la red doméstica existente, ha de seguir varios pasos sencillos:

Precaución

- No conecte el cable Ethernet si va a conectar el altavoz a una red inalámbrica. Si va a conectar el altavoz a una red con cable, utilice un cable Ethernet (a la venta por separado) para conectar el altavoz a la red o al enrutador.

1 Asegúrese de que su dispositivo móvil esté conectado a su red inalámbrica (la misma red a la que desea conectar sus altavoces).

Puede comprobar esto en el menú "Ajustes" - "Wi-Fi" de su dispositivo con iOS o Android.

NOTA

- Active el ajuste de Bluetooth en su dispositivo móvil.
- Si la red inalámbrica está protegida, debe introducir la contraseña para conectarse a la red.

2 Inicie la aplicación HEOS en su dispositivo móvil.

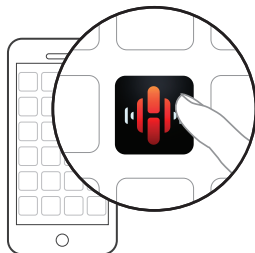

3 Toque el botón "Configurar ahora" en la parte superior de la pantalla.

4 Siga las instrucciones para agregar el altavoz a la red inalámbrica.

NOTA

- Si tiene algún problema para conectar el altavoz, vaya a la sección Resolución de problemas (ícono p. 50).



Añadir más altavoces

El sistema HEOS es un verdadero sistema de audio para varias habitaciones que sincroniza automáticamente la reproducción de audio entre varios altavoces, de modo que el audio procedente de diferentes habitaciones está perfectamente sincronizado ¡y siempre tiene un sonido espectacular! Puede añadir fácilmente hasta 32 altavoces al sistema HEOS.

Cómo agregar altavoces con cable

Simplemente conecte el altavoz a su red doméstica mediante un cable Ethernet, y el altavoz aparecerá en su aplicación HEOS como una nueva habitación en la pantalla “Habitaciones”.

Puede asignar un nombre al altavoz en el momento que le convenga para señalar la habitación donde lo ha colocado.



- Utilice únicamente un cable LAN STP o ScTP blindado, el cual se puede adquirir fácilmente en cualquier tienda de productos electrónicos (se recomienda el tipo CAT-5 o superior).
- No enchufe un conector de RED directamente al puerto LAN/conector Ethernet del ordenador.

Añadir altavoces inalámbricos

Puede añadir altavoces adicionales a su sistema HEOS seleccionando “Agregar dispositivo” desde el menú de ajustes de la aplicación HEOS y siguiendo las instrucciones:

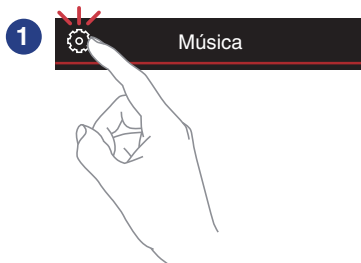

Instrucciones de uso del altavoz

Una vez conectado su altavoz a la red, y tras instalar la aplicación HEOS en el dispositivo móvil, empezar a disfrutar de su música favorita es muy fácil. Puede escuchar algo diferente en cada altavoz o la misma música perfectamente sincronizada en todos los altavoces. ¡Usted decide!

Selección de una habitación o un altavoz

Si tiene más de un altavoz, debe indicar al sistema HEOS qué altavoz quiere controlar:

- 1** Toque la pestaña “Habitaciones”.
- 2** Seleccione la habitación o el altavoz que desee controlar.
- 3** Seleccione la pestaña “Música” para seleccionar una fuente de música o la pestaña “Reproducción en curso” para controlar aquello que se esté reproduciendo actualmente en la habitación seleccionada.

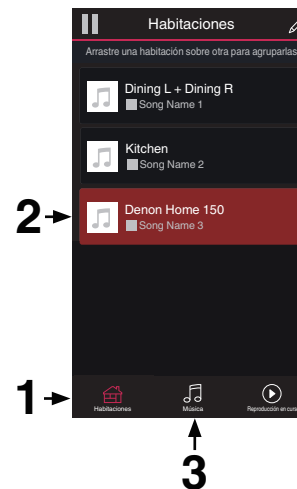

Función de selección rápida

Los ajustes de la fuente de entrada se pueden registrar en los botones de selección rápida (1 - 3).

1 Para registrar la configuración actual, mantenga presionado uno de los botones de selección rápida (1 - 3) en el panel superior durante 3 segundos.



- El LED de estado parpadea una vez al completar el registro.
- Para recuperar la configuración registrada, presione el botón de selección rápida en el panel superior.

[Configuración predeterminada]

Botón	Fuente de entrada
Quick Select 1	Entrada AUX
Quick Select 2	-
Quick Select 3	-



Cómo escuchar la radio

El sistema HEOS incluye el acceso a más de 100.000 emisoras de radio por Internet gratuitas de todos los rincones del mundo a través del servicio de radio Tuneln. Simplemente seleccione el logotipo de Tuneln del menú principal "Música", navegue por las 100.000 emisoras organizadas con esmero por categorías populares y seleccione la emisora que le apetezca escuchar.

NOTA

- Si tiene una cuenta de Tuneln, puede iniciar sesión en el servicio Tuneln en "Ajustes" - "Fuentes de música" - "Tuneln" y acceder a todas sus emisoras de Tuneln guardadas en "Mis Favoritos".

■ ■ ■ Señal de audio

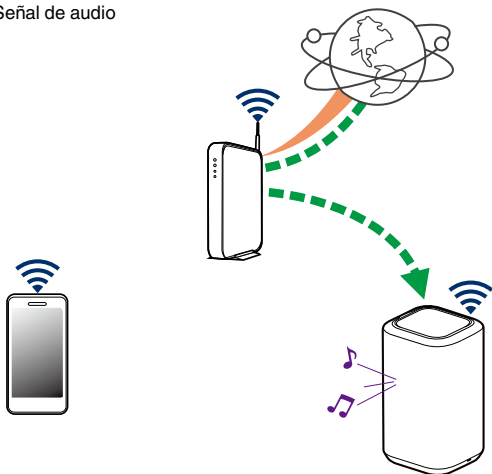

Reproducción de música almacenada en un dispositivo móvil

- 1 Toque la pestaña "Música".
- 2 Seleccione "Este teléfono/iPhone/iPod/iPad".
- 3 Navegue por la música local del teléfono y seleccione algo que quiera reproducir.

■ ■ ■ Señal de audio

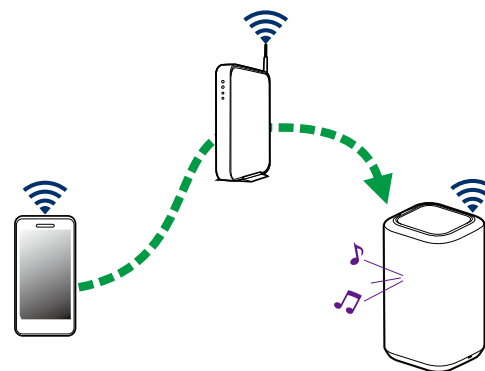

Reproducción de música del PC o un dispositivo de almacenamiento conectado a la red

- 1** Seleccione “Servidores Musicales” en la pestaña “Música”.
- 2** Seleccione el nombre del PC o del servidor NAS (Network Attached Storage) que esté conectado a la red.
- 3** Navegue por la música local del PC o NAS y seleccione algo que quiera reproducir.

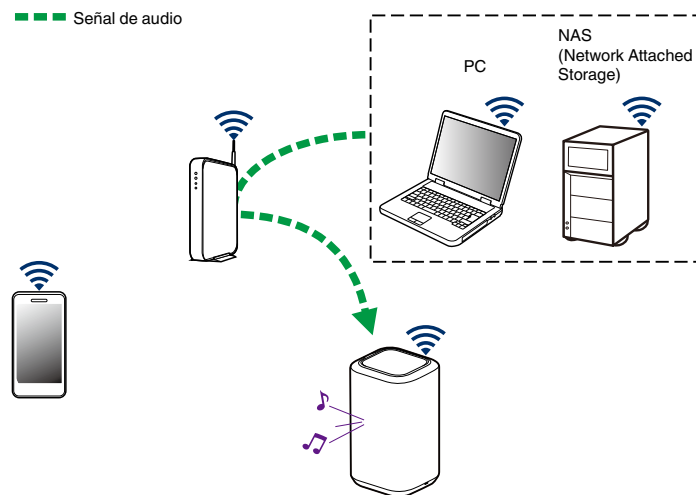

Reproducción de música de la entrada AUX

1 Conecte un dispositivo de audio con una salida de audio estéreo con conector de 3,5 mm a la entrada AUX del altavoz por medio de un cable de audio estéreo de 3,5 mm a la venta por separado.

Cuando se conecta un cable de audio estéreo de 3,5 mm a "AUX IN", la fuente cambia automáticamente a Entradas.

NOTA

- Cuando haya un cable conectado a AUX IN, seleccione "Entradas" en la pestaña "Música".

2 Inicie la reproducción en el dispositivo de audio.



- El sonido del dispositivo de audio puede reproducirse directamente a través del altavoz seleccionado, o puede digitalizarse y enviarse a través de la red a otros altavoces.

NOTA

- Las señales de salida analógica procedentes de algunas fuentes pueden ser bastante fuertes. Si aumenta el nivel de entrada del dispositivo fuente, podría sobrecargar las entradas del altavoz. No es probable que esto cause daños, pero puede provocar un sonido distorsionado. Al principio, establezca el volumen de la fuente en un nivel medio-bajo para posteriormente subirlo según sea necesario. Si el sonido se escucha distorsionado, baje el control de volumen del dispositivo.

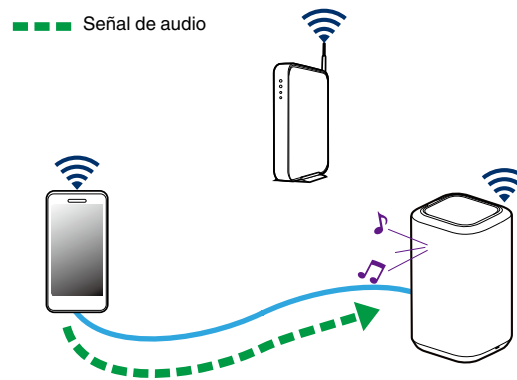

Reproducción de música de un dispositivo de memoria USB

- 1** Inserte un dispositivo de memoria USB con formato FAT32 o NTFS en el puerto USB del panel trasero del altavoz.
- 2** Seleccione “Música USB” en la pestaña “Música”.
- 3** Seleccione el nombre de su altavoz.
- 4** Navegue por la música local del dispositivo de memoria USB y seleccione algo que desee reproducir.

NOTA

- Puede que el nombre de su altavoz tarde varios minutos en aparecer en la lista de “Música USB” si tiene almacenados un gran número de archivos en el dispositivo de memoria USB.
- No es posible conectar y utilizar un ordenador mediante el puerto USB de esta unidad usando un cable USB.

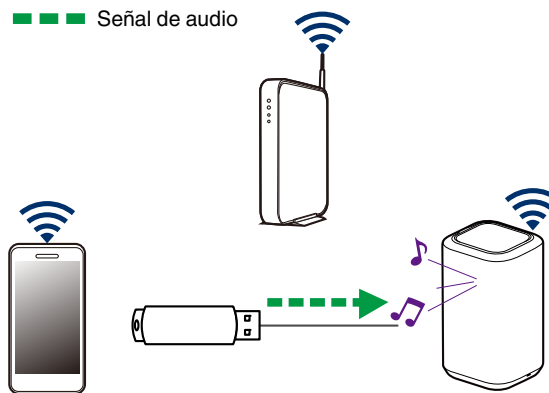

Reproducción de música de un dispositivo Bluetooth

■ Emparejamiento del altavoz con sus dispositivos Bluetooth

- 1 Active el ajuste de Bluetooth en su dispositivo móvil.
- 2 Mantenga pulsado el botón Bluetooth (📶) situado en el panel trasero del altavoz durante 3 segundos y suéltelo cuando observe un patrón de dos parpadeos verdes en el LED de estado.

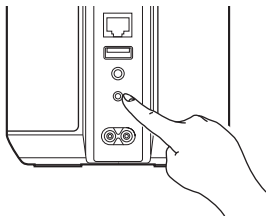

- 3 Selecteer “Denon Home 150” in de lijst van beschikbare Bluetooth-apparaten.
En unos segundos su móvil le indicará que se ha conectado al altavoz.
- 4 Reproduzca música utilizando cualquier aplicación de su dispositivo.
El sonido se reproducirá ahora a través del altavoz.

■ ■ ■ Señal de audio

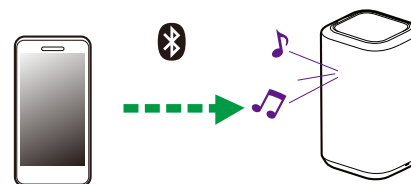

NOTA

- Desconecte y vuelva a conectar las conexiones Bluetooth de su dispositivo Bluetooth.



Cuenta HEOS

■ ¿En qué consiste una cuenta de HEOS?

Una cuenta de HEOS es una cuenta maestra o “cadena clave” para administrar todos sus servicios de música con un solo nombre de usuario y contraseña.

■ ¿Por qué necesito una cuenta de HEOS?

Con la cuenta de HEOS solo tiene que introducir una sola vez el nombre de usuario y la contraseña para iniciar sesión en los servicios de música. Esto le permite utilizar de forma rápida y sencilla varias aplicaciones de controlador en diferentes dispositivos. Simplemente inicie sesión en su cuenta de HEOS en cualquier dispositivo y dispondrá de acceso a todos sus servicios de música asociados, al historial de reproducción y a las listas de reproducción personalizadas, aunque esté en casa de un amigo escuchando música en su sistema HEOS.

■ Registro en una cuenta de HEOS

Se le facilitarán las instrucciones de registro en una cuenta HEOS la primera vez que intente acceder a cualquier servicio de música a través del menú principal “Música” de la aplicación HEOS.

■ Cambiar su cuenta HEOS

- 1 Toque la pestaña “Música”.
- 2 Seleccione el icono de ajustes  situado en la esquina superior izquierda de la pantalla.
- 3 Seleccione “Cuenta HEOS”.
- 4 Cambie su ubicación, cambie su contraseña, elimine su cuenta o cierre la sesión de su cuenta.



Reproducción de servicios de transmisión de música

Un servicio de música es una empresa de música en línea que brinda acceso a enormes colecciones de música a través de suscripciones gratuitas o de pago. En función de la ubicación geográfica donde se encuentre, puede elegir varias opciones.

NOTA

- La app y la marca HEOS no están afiliadas con ningún fabricante de dispositivos móviles. La disponibilidad de servicios de música puede variar según la región. En el momento de la compra es posible que no estén disponibles todos los servicios. Algunos servicios pueden añadirse o suspenderse periódicamente según las decisiones de los proveedores de servicios de música u otros.

■ Cómo agregar un servicio de música

Una vez haya configurado su cuenta de HEOS, puede agregar servicios de música admitidos a su sistema HEOS con solo tocar el logotipo del servicio de música en la pestaña “Música”.

Siga las instrucciones que aparecen en la pantalla para agregar el nombre de usuario y la contraseña del servicio de música seleccionado. Solamente ha de introducir la información de su cuenta una vez, puesto que el servicio de cuenta de HEOS almacena de forma segura la información de inicio de sesión para que no tenga que introducirla cada vez que desee reproducir música del servicio de música.

Puede que haya servicios de música adicionales en Ajustes – Fuentes de música - Música online.

■ Cambio de los ajustes del servicio de música

- 1 Toque la pestaña “Música”.
- 2 Seleccione el icono de ajustes  situado en la esquina superior izquierda de la pantalla.
- 3 Seleccione “Fuentes de música”.
- 4 Seleccione “Música online”.
- 5 Seleccione el nombre del servicio de música en línea que desee editar.
- 6 Cierre sesión y, a continuación, inicie sesión de nuevo para asociar su nombre de usuario y contraseña con su cuenta de HEOS.
- 7 Seleccione “Ocultar por ahora” para evitar que el logotipo del servicio aparezca en el menú principal “Música”.



Administración de entradas

Si conectó componentes de fuente de audio externos a cualquiera de las entradas de los altavoces, puede cambiar los nombres de entrada predeterminados para describir la fuente actual u ocultar las entradas que no se están utilizando.

- 1** Seleccione el icono de ajustes  situado en la esquina superior izquierda del menú principal “Música” para ver el menú Settings.
- 2** Seleccione “Fuentes de música”.
- 3** Seleccione “Entradas”.
- 4** Seleccione el altavoz al que vaya a conectar el dispositivo externo de fuente de audio.

■ Cambio del nombre de las entradas

- 1** Seleccione el nombre de la entrada que desee editar.
- 2** Seleccione “Nombre”.
- 3** Seleccione o introduzca un nuevo nombre que describa la fuente que ha conectado.
- 4** Seleccione el botón de guardar para guardar los cambios.

■ Ocultar una entrada

- 1** Seleccione el nombre de la entrada que desee editar.
- 2** Cambie la opción “Ocultar Entrada” a ON para evitar que esta entrada aparezca bajo el título Entradas del menú principal “Música”.



Administración de su teléfono

Puede ocultar su smartphone o tablet si no es preciso que aparezca en el menú “Fuentes de música”.

- 1** Seleccione el icono de ajustes  situado en la esquina superior izquierda del menú principal “Música” para ver el menú Settings.
- 2** Seleccione “Fuentes de música”.
- 3** Seleccione “Este teléfono/iPhone/iPod/iPad”.
- 4** Cambie “Este teléfono/iPhone/iPod/iPad” a OFF para evitar que el logotipo del servicio aparezca en el menú principal “Música”.



Cómo escuchar la misma música en varias habitaciones

El sistema HEOS es un verdadero sistema de audio de varias habitaciones que sincroniza automáticamente la reproducción de audio entre varios altavoces, de modo que el audio que procede de diferentes habitaciones está perfectamente sincronizado ¡y siempre tiene un sonido espectacular!

Puede añadir fácilmente hasta 32 altavoces a su sistema HEOS.

Puede reunir o agrupar hasta 16 altavoces individuales en un grupo de altavoces que funcionan como si fueran un solo altavoz.

■ Agrupación de habitaciones

- 1 Mantenga el dedo sobre la habitación en la que no se esté reproduciendo música.**
- 2 Arrástrelo hasta la habitación en la que se esté reproduciendo música (indicado por el contorno rojo) y levante el dedo.**

Las dos habitaciones se agrupan en un solo grupo de dispositivos, y en ambas habitaciones se reproduce la misma música con una sincronización perfecta.

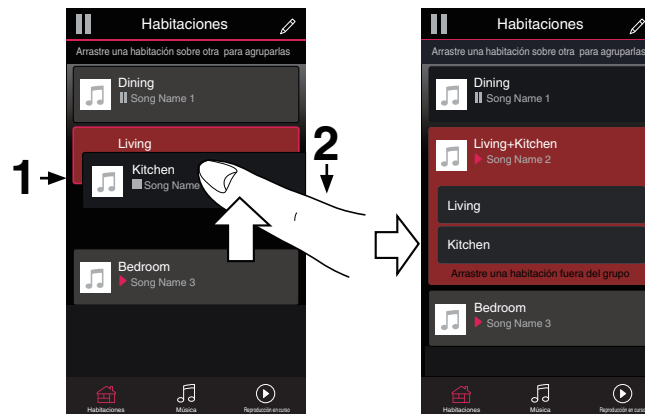

■ Eliminación de una agrupación de habitaciones

1 Mantenga el dedo sobre la habitación que desee eliminar del grupo.

NOTA

- No puede eliminar la primera habitación en la que comenzó la reproducción de música antes de realizarse la agrupación.

2 Arrástrelo hasta fuera del grupo y levante el dedo.

La música deja de reproducirse en la habitación que ha arrastrado fuera del grupo, pero sigue reproduciéndose en el resto de habitaciones.



■ Agrupación de todas las habitaciones (modo de fiesta)

Puede agrupar fácilmente 16 habitaciones en modo fiesta utilizando un gesto de “pellizcar” la pantalla.

- 1 Coloque los dos dedos en la pantalla sobre la lista de habitaciones.**
- 2 Acerque rápidamente los dos dedos hasta que estén juntos y levántelos.**

Todas las habitaciones se agrupan y comienza en todas ellas la reproducción de la misma música en perfecta sincronía.

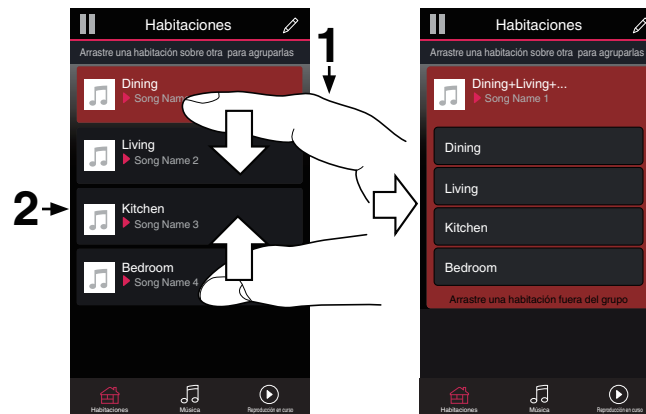

■ Eliminación de la agrupación de todas las habitaciones

Puede eliminar fácilmente la agrupación de todas las habitaciones y salir del modo de fiesta mediante un gesto de “alejarse” los dedos.

- 1 Coloque los dos dedos juntos en la pantalla sobre la lista de habitaciones.**
- 2 Aleje rápidamente los dos dedos hasta que se separen entre sí y levántelos.**

La agrupación de todas las habitaciones queda eliminada y la música deja de reproducirse en todas las habitaciones (excepto en la habitación “principal” original en la que se estaba reproduciendo la música antes de agrupar las habitaciones).



Emparejamiento estéreo

■ Creación de un par estéreo

Un par de altavoces emparejados que se hayan agrupado juntos (véase más arriba) se pueden almacenar como un par estéreo habitual, en el que un altavoz solo emite el canal izquierdo de audio, mientras que el otro altavoz emite solo el canal derecho de audio. Los altavoces emparejados aparecerán entonces como si fueran una única Habitación (con dos altavoces reproduciendo música) en la lista Habitaciones.

- 1** Toque la pestaña “Habitaciones”.
- 2** Cree un grupo que SOLO conste de dos altavoces emparejados (véase “Agrupación de habitaciones” (p. 27)).
- 3** Toque el icono de lápiz para acceder al modo de edición.
- 4** Toque en el grupo de los dos altavoces emparejados para editar el grupo.

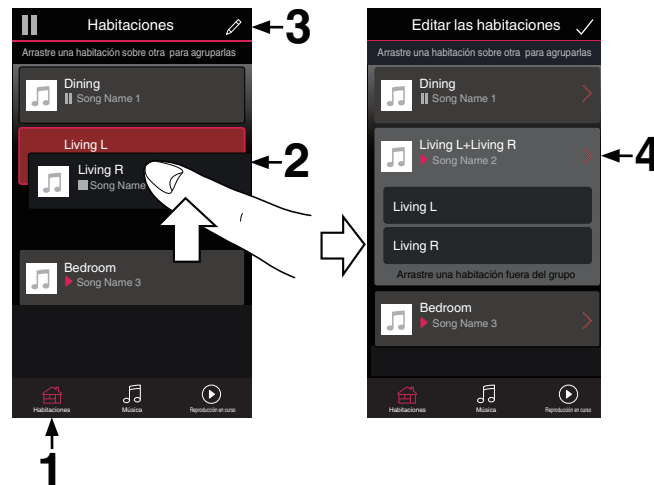

5 Toque el interruptor del par estéreo para emparejar los dos altavoces.



6 Toque la flecha Atrás  para volver a la lista de Habitaciones.

7 Toque el icono de la marca de verificación  para salir del modo de edición.

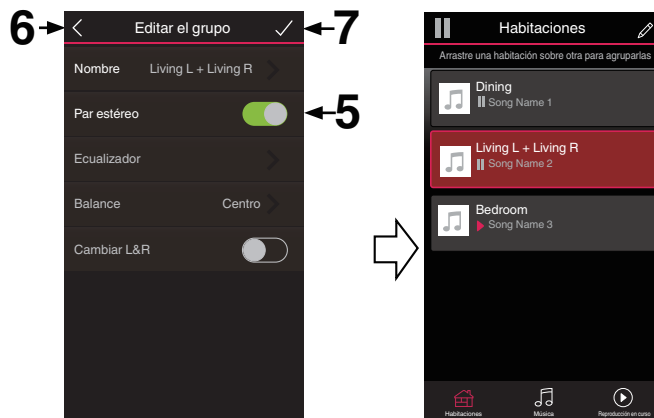

El grupo de los dos altavoces emparejados aparecerá ahora como una única Habitación. Puede cambiar el nombre de la habitación de los altavoces del par estéreo en cualquier momento.



■ Cambio del nombre de un par estéreo



- 1 Toque la pestaña “Habitaciones”.
- 2 Toque el icono de lápiz  para acceder al modo de edición.
- 3 Toque un par estéreo (una habitación que conste de dos altavoces emparejados) para editar el grupo.
- 4 Toque “Nombre”.
- 5 Seleccione o introduzca un nombre nuevo para el par de altavoces.
- 6 Toque el botón de guardar  para guardar los cambios.

■ Ajuste del Balance



- 1 Toque la pestaña “Habitaciones”.
- 2 Toque el icono de lápiz  para acceder al modo de edición.
- 3 Toque un par estéreo (una habitación que conste de dos altavoces emparejados) para editar el grupo.
- 4 Seleccione “Balance”.
- 5 Ajuste el balance hacia la izquierda o hacia la derecha.
- 6 Toque el icono de la marca de verificación  para salir del modo de edición.



■ Intercambio de los canales izquierdo y derecho en un par estéreo

- 1 Toque la pestaña “Habitaciones”.
- 2 Toque el icono de lápiz  para acceder al modo de edición.
- 3 Toque un par estéreo (una habitación que conste de dos altavoces emparejados) para editar el grupo.
- 4 Toque el interruptor Swap L&R para intercambiar los canales izquierdo y derecho de los dos altavoces.
- 5 Toque la flecha Atrás  para volver a la lista de Habitaciones.
- 6 Toque el icono de la marca de verificación  para salir del modo de edición.

■ Eliminación de un par estéreo

- 1 Toque la pestaña “Habitaciones”.
- 2 Toque el icono de lápiz  para acceder al modo de edición.
- 3 Toque un par estéreo (una habitación que conste de dos altavoces emparejados) para editar el grupo.
- 4 Toque el interruptor del par estéreo para hacer que los altavoces emparejados vuelvan a su configuración como dos altavoces individuales.
- 5 Toque la flecha Atrás  para volver a la lista de Habitaciones.
- 6 Toque el icono de la marca de verificación  para salir del modo de edición.



Uso de la cola de reproducción

El sistema HEOS utiliza una “Cola” de reproducción en curso para ordenar la música que desee escuchar. Puede seleccionar la música de cualquier fuente de música local o en línea (siempre que no se traten de transmisiones del tipo de “radio” o “emisora” preprogramada). Esta función es similar al funcionamiento de una gramola. Seleccione un contenido para reproducir (una canción, un álbum, una lista de reproducción o, incluso, toda su colección de música) y agréguelo a la “Cola”. Cuando seleccione una pista para reproducir se le preguntará cómo desea que su música sea colocada en la cola.

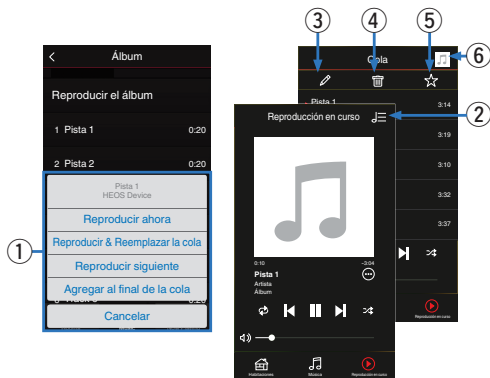

1 Menú de cola

Cuando selecciona una pista para reproducir se le preguntará cómo desea que su música sea colocada en la cola.

2 Icono de cola

3 Icono de lápiz

4 Icono de eliminación

5 Icono de almacenamiento

6 Cubierta o el ícono HEOS

Puede volver a la pantalla “Reproducción en curso” tocando la cubierta o el ícono HEOS.

■ Reproducir ahora

El elemento se inserta en la cola después de la pista que se está reproduciendo y el elemento seleccionado se reproduce de inmediato.

■ Reproducir & Reemplazar la cola

Se elimina la cola y el elemento seleccionado se reproduce de inmediato.

■ Reproducir siguiente

El elemento se inserta en la cola después de la canción actual y se reproduce cuando termina la reproducción de la canción actual.



■ Agregar al final de la cola

El elemento se agrega al final de la cola.





Reorganización de la cola de reproducción

Una vez que las canciones se hayan puesto en cola, es posible que quiera reorganizar el orden o eliminar algunas canciones:

- 1** Toque la pestaña “Reproducción en curso”.
- 2** Toque el icono de cola  situado en la esquina superior derecha de la pantalla.
- 3** Toque el icono de lápiz  para acceder al modo de edición.
- 4** Para reorganizar el orden de la cola, arrastre el icono de lista  (situado en el lado derecho de cada fila de pista) hacia arriba o abajo.

Eliminación de canciones de la cola de reproducción



Puede eliminar canciones una a una de la cola de reproducción:

- 1** Toque la pestaña “Reproducción en curso”.
- 2** Toque el icono de cola  situado en la esquina superior derecha de la pantalla.
- 3** Toque el icono de lápiz  para acceder al modo de edición.
- 4** Toque las pistas que desee eliminar.
- 5** Toque el icono de eliminación  para eliminar todas las pistas seleccionadas de la cola de reproducción.





Eliminación de todas las canciones de la cola de reproducción

Puede eliminar todas las canciones de la cola de reproducción:

- 1 Toque la pestaña “Reproducción en curso”.
- 2 Toque el icono de cola  situado en la esquina superior derecha de la pantalla.
- 3 Pulse el icono Borrar  para confirmar que desea eliminar todas las canciones de la cola.



Almacenamiento de listas de reproducción

Puede guardar la cola de reproducción como lista de reproducción de HEOS y recuperarla posteriormente. La nueva lista de reproducción estará disponible a través del botón Playlists en la pestaña “Música” en cada aplicación de controlador que se conecte a su sistema HEOS.

- 1 Toque la pestaña “Reproducción en curso”.
- 2 Toque el icono de cola  situado en la esquina superior derecha de la pantalla.
- 3 Toque el icono de guardar .
- 4 Introduzca un nombre para la lista de reproducción y toque el icono de .

Realización de las funciones de repetición y reproducción de forma aleatoria

Los controles de reproducción pueden verse en la pantalla “Reproducción en curso”.

- 1 Toque la pestaña “Reproducción en curso”.
- 2 Toque la cubierta para mostrar los controles de repetición  y reproducción aleatoria .



Uso de los favoritos

El sistema HEOS utiliza un “Favoritos HEOS” para alinear la emisora que desea que comience a reproducirse rápidamente de las emisoras favoritas.

La emisora puede ser seleccionada desde fuentes de música en línea tales como transmisiones del tipo “Radio” o “Emisora”. “Favoritos HEOS” mostrará una lista de las emisoras de varios servicios.

■ Añadir a los favoritos de HEOS

Seleccione una emisora de una fuente de música en línea. Cuando se muestre la pantalla de menú de acción seleccione “Agregar la emisora a Favoritos HEOS”.

NOTA

- Esto también se puede hacer seleccionando “Agregar la emisora a Favoritos HEOS” desde el menú de emisora de la emisora que se esté reproduciendo.

■ Eliminar una emisora de los favoritos de HEOS

- 1 Toque la pestaña “Música”.
- 2 Seleccione “Favoritos”.
- 3 Toque el icono de lápiz  para acceder al modo de edición.
- 4 Toque el icono “Eliminar” de la emisora que desee eliminar.



Función de AirPlay

Se pueden reproducir en esta unidad los archivos de música almacenados en su iPhone, iPod touch, iPad o iTunes, a través de la red.

■ ■ ■ Señal de audio

NOTA

- La pantalla puede variar en función del sistema operativo y las versiones del software.

Este dispositivo es compatible con AirPlay 2®.

Sincronización de varios dispositivos/altavoces compatibles con AirPlay 2 para reproducir de forma simultánea.



- Esta unidad es compatible con AirPlay 2 y requiere iOS 11.4 o posterior.

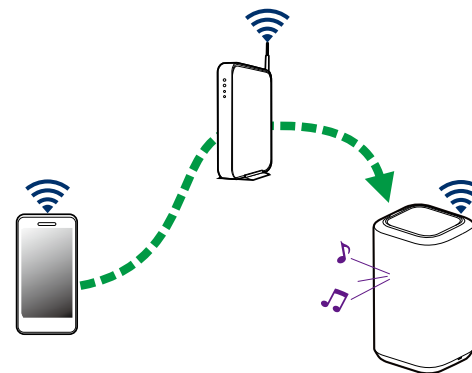

Reproducción de canciones desde su iPhone, iPod touch o iPad

Si actualiza su “iPhone/iPod touch/iPad” a la versión iOS 4.2.1 o posterior, podrá transmitir la música almacenada en el “iPhone/iPod touch/iPad” directamente a esta unidad.

- 1 Conecte su iPhone, iPod touch o iPad con Wi-Fi a la misma red que esta unidad.**
 - Para obtener información, consulte el manual de su dispositivo.
- 2 Reproduzca la canción en su iPhone, iPod touch o iPad.**

El icono AirPlay se muestra en la pantalla del iPhone, iPod touch o iPad.
- 3 Toque el icono AirPlay y seleccione esta unidad.**

[Ejemplo] iOS 12



[Ejemplo] iOS 9



Reproducción de música de iTunes con su altavoz

- 1 Instale iTunes 10, o posterior, en un Mac o PC con Windows que esté conectado a la misma red que esta unidad.**
- 2 Inicie iTunes y haga clic en el icono AirPlay para seleccionar esta unidad.**

[Ejemplo] iTunes

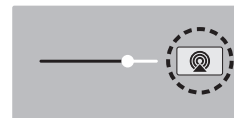

- 3 Elija una canción y seleccione la opción de reproducir en iTunes.**

La música se transmitirá a esta unidad.



Reproduzca una canción desde su iPhone, iPod touch o iPad en múltiples dispositivos sincronizados (AirPlay 2)

Las canciones de un iPhone, iPod touch o iPad que funcione con iOS 11.4 o posterior, pueden sincronizarse con varios dispositivos compatibles con AirPlay 2 para reproducir de forma simultánea.

1 Reproduzca la canción del iPhone, iPod touch o iPad.

Icono AirPlay se muestra en la pantalla del iPhone, iPod touch o iPad.



2 Puntee el icono AirPlay.

Muestra una lista de dispositivos/altavoces que se pueden reproducir en la misma red.

- Se muestra un círculo a la derecha de los dispositivos compatibles con la tecnología AirPlay 2.



3 Toque los dispositivos/altavoces que desee usar.

- Se pueden seleccionar varios dispositivos compatibles con AirPlay 2.
- El volumen se puede ajustar para cada dispositivo por separado o simultáneamente para todos los dispositivos sincronizados.



Configuración de los ajustes del altavoz

Puede configurar ajustes específicos de cada altavoz del sistema:

- 1** Seleccione el icono de ajustes  situado en la esquina superior izquierda del menú principal “Música” para ver el menú Settings.
- 2** Seleccione “Mis dispositivos” para visualizar una lista de sus altavoces.
- 3** Seleccione el altavoz que desee ajustar.

Cambio del nombre de un altavoz

- 1** Seleccione “Nombre”.
- 2** Seleccione o introduzca un nombre nuevo para el altavoz.
- 3** Toque el icono de  para guardar los cambios.

Cambio de la conexión de red inalámbrica

- 1** Seleccione “Red”.
Se muestra una lista con las redes inalámbricas a las que puede acceder el altavoz.
- 2** Seleccione la red a la que desee conectar el altavoz.
Espere mientras cambia la conexión de red del altavoz.

NOTA

- Cuando el altavoz se conecta a una red Ethernet con cable, se selecciona automáticamente la conexión con cable. Para volver a utilizar una red inalámbrica, debe desconectar el cable Ethernet del panel trasero del altavoz.



Cambio del ecualizador del altavoz

- 1 Seleccione “Ecualizador”.
- 2 Ajuste los “Agudos” o “Graves” hacia arriba o abajo.

NOTA

- Seleccione el botón Reiniciar para restablecer la configuración predeterminada.

Ajuste de la calidad de audio

Selecciona la opción de transcodificación para la retransmisión de audio desde un altavoz a otro altavoz (o grupo de dispositivos) a través de la red.

Cuando se ajusta a alta velocidad de bits, las fuentes de audio procedentes del primer dispositivo (como la entrada analógica, WAV, FLAC y PCM) se transcodificarán para garantizar el nivel más alto de fiabilidad para la transmisión de audio.

- 1 Seleccione “Calidad”.
- 2 Seleccione “Normal” (predeterminado) o “Alto”.



- Si ha seleccionado “Alto” y ocurren cortes de audio durante la transmisión de fuentes de un dispositivo a otros dispositivos, seleccione “Normal” (predeterminado).

Ajuste de la luminosidad de la luz de estado

- 1 Seleccione “Led indicador estado”.
- 2 Ajuste una mayor o menor luminosidad o coloque el deslizador en la posición Apagado para desactivar completamente la luz de estado.



Configuración avanzada del altavoz

Precaución

- Si cambia estos ajustes, es posible que el altavoz se desconecte de la red y no se pueda utilizar más. No utilice estas funciones a menos que tenga conocimientos sobre cómo realizar ajustes avanzados en el altavoz.

■ Ajustes de red

- 1** Seleccione “Configuración avanzada”.
- 2** Seleccione la pestaña “NETWORK SETTINGS”.
- 3** Desplácese hacia abajo para ver todas las opciones de
 - a. Network Interface (Ethernet or Wireless)
 - b. Wireless Settings
 - c. IP Address Settings (Automatic or Manual)
 - d. Wireless Power Saving
- 4** Seleccione Save Settings para aplicar la nueva configuración, o Cancel Changes para restaurar la configuración anterior.

■ Acerca del ahorro de energía en modo inalámbrico

La función de ahorro de energía en modo inalámbrico ahorra energía desactivando la radio inalámbrica integrada en el altavoz cuando el dispositivo se encuentra conectado a una red Ethernet. Si desconecta el cable Ethernet del altavoz, se desactivará automáticamente el ahorro de energía en modo inalámbrico y se encenderá la radio para que la red inalámbrica pueda detectar el altavoz.

NOTA

- Si la función de ahorro de energía en modo inalámbrico está activada, la alimentación de Wi-Fi se activará temporalmente cuando acceda a la pantalla “Mis dispositivos” - (“Nombre del dispositivo”) - “Red” en la aplicación HEOS o cuando se pulse el botón CONNECT en el dispositivo.



■ Actualización de firmware

- 1 Seleccione “Configuración avanzada”.
- 2 Seleccione la pestaña “FIRMWARE UPDATE”.

Update status

Compruebe manualmente si hay una actualización de firmware.

Allow updates

ON
(predeterminado): Permite actualizaciones

OFF: No permite actualizaciones

- 3 Seleccione **Save Settings** para aplicar la nueva configuración, o **Cancel Changes** para restaurar la configuración anterior.

■ Acerca de

Consulta de los datos técnicos acerca del altavoz.

- 1 Seleccione “Configuración avanzada”.
- 2 Seleccione la pestaña “ABOUT”.
- 3 Desplácese hacia abajo para consultar la información acerca de los siguientes elementos del altavoz
 - a. Hardware
 - b. Software
 - c. Device



Actualización del sistema

El sistema HEOS tiene la capacidad de añadir mejoras y funcionalidad actualizada a través de su conexión a Internet de alta velocidad. Siga las instrucciones de la pantalla para actualizar el altavoz y/o su aplicación de controlador.

1 Seleccione el icono de ajustes  situado en la esquina superior izquierda del menú principal “Música” para ver el menú Settings.

2 Seleccione “Actualización de software”.

Buscar actualizaciones

Siga las instrucciones que aparecen en pantalla para instalar cualquier actualización que haya disponible para su sistema HEOS.

Actualización automática

ON (predeterminado):	Las actualizaciones válidas se realizan de forma automática.
OFF:	Recibirá una notificación de las actualizaciones válidas en la aplicación HEOS.



Funciones avanzadas

Existen unas cuantas funciones avanzadas del sistema HEOS que tal vez desee explorar una vez que se familiarice con las operaciones básicas. Puede acceder a las funciones avanzadas del sistema HEOS si sigue los pasos siguientes:

- 1 Seleccione el icono de ajustes  situado en la esquina superior izquierda del menú principal “Música” para ver el menú Settings.**
- 2 Seleccione “Configuración avanzada” para ver una lista con las opciones disponibles.**

Intercambio de música de un dispositivo móvil

La aplicación HEOS cuenta con una función denominada “Uso compartido de música” que permite compartir la música local almacenada en su dispositivo móvil con otros usuarios de la aplicación HEOS en su red local. Para activar esta función, seleccione “Uso compartido de música” y ajústela como “EN”.

El nombre del dispositivo del que comparte contenido aparece como un servidor de música, con lo que se permite a otras aplicaciones HEOS navegar por la música del dispositivo y reproducirla.

Rendimiento inalámbrico

Puede comprobar el estado de conexión inalámbrica de su altavoz.

Calidad

Excelente / Buena / Deficiente

NOTA

- Si el nivel de calidad de su altavoz es “Deficiente”, asegúrese de que sus altavoces no estén ubicados cerca de otros dispositivos electrónicos que pudieran interferir con su conectividad inalámbrica (como hornos microondas, teléfonos inalámbricos, TV, etc.)

Señal

Excelente / Buena / Deficiente

NOTA

- Si el nivel de señal de su altavoz es “Deficiente”, asegúrese de que sus altavoces se encuentren dentro del alcance de su red inalámbrica.



Enviar diagnósticos

Si está experimentando problemas con su red o sistema HEOS, puede que el personal de asistencia técnica de Denon le indique que seleccione esta opción. Esta función enviará automáticamente al departamento de asistencia técnica de Denon información de diagnóstico sobre su sistema HEOS.

NOTA

- No se envía ninguna información personal y nunca se compartirá esta información con nadie.

Restablecimiento de la aplicación de controlador

Esta función permite restablecer la aplicación de control a como estaba originalmente cuando se instaló por primera vez en el dispositivo móvil sin que tenga que eliminarla, descargarla de nuevo de la tienda de aplicaciones y volver a instalarla.



Gestión de alimentación

Modos de alimentación

■ Modo de inicio rápido

Este altavoz accede automáticamente al “Modo de inicio rápido” para ahorrar energía en los siguientes casos. Durante el “Modo de inicio rápido”, las operaciones de los altavoces provocan la activación de la fuente de alimentación.

Durante el “Modo de inicio rápido”, el LED de estado se ilumina en azul oscuro.

❑ Ethernet

Tras permanecer inactivo y sin acceso a la red durante un período de unos 20 minutos después de reproducir música a través de Ethernet.

❑ Wi-Fi

Tras permanecer inactivo y sin acceso a la red durante un período de unos 20 minutos después de reproducir música a través de Wi-Fi.

❑ USB

Tras permanecer inactivo y sin acceso a la red durante un período de unos 20 minutos después de reproducir música a través de un dispositivo de memoria USB.

❑ Bluetooth

Después de la desconexión del Bluetooth y tras permanecer inactivo y sin acceso a la red durante un período de unos 20 minutos después de reproducir música a través de Bluetooth.

❑ AUX IN

Después de aproximadamente 20 minutos sin audio.

■ Modo de espera completo

El dispositivo también puede entrar en “Modo de espera completo” automáticamente siempre que se elimina la conexión de red inalámbrica o con cable durante más de 60 minutos en el “modo de inicio rápido”. El LED del panel delantero se apagará durante Modo de espera completo.

Presione cualquier botón para activar la unidad.



- Pulse también el botón ▶|| durante 5 segundos y el dispositivo entrará en el modo de espera completo.

■ Apagado

Para apagar completamente el dispositivo, debe quitar la clavija de la fuente de alimentación de la toma de corriente.



Resolución de problemas básicos

No es posible conectar el altavoz a la red

Solución	Consulte la página
<ul style="list-style-type: none"> Asegúrese de que su dispositivo móvil está conectado a su red inalámbrica antes de configurar su altavoz. 	14
<ul style="list-style-type: none"> De forma opcional, puede conectar el altavoz a su enrutador de red mediante un cable Ethernet a la venta por separado. Una vez que se conecta mediante Ethernet, la aplicación HEOS deberá reconocer el altavoz y podrá moverlo manualmente a su red inalámbrica utilizando "Ajustes" - "Mis dispositivos" - ("Nombre del dispositivo") - "Configuración avanzada" - "Ajustes de red". 	15

No es posible emparejar un dispositivo móvil Bluetooth con el altavoz

Solución	Consulte la página
<ul style="list-style-type: none"> La conexión del dispositivo móvil Bluetooth no funciona correctamente. Encienda y apague el dispositivo móvil, elimine la información de emparejamiento y vuelva a emparejar el altavoz y el dispositivo móvil. 	-



No puedo escuchar la música procedente de la conexión Bluetooth

Solución	Consulte la página
<ul style="list-style-type: none"> • El dispositivo móvil Bluetooth no está emparejado con el altavoz. Vuelva a emparejar el altavoz al dispositivo móvil. 	-
<ul style="list-style-type: none"> • El altavoz está en modo Wi-Fi o en el modo auxiliar, etc. Empareje el dispositivo Bluetooth con el altavoz y conéctelo. 	-
<ul style="list-style-type: none"> • El dispositivo móvil Bluetooth se encuentra conectado a otro dispositivo de audio. Asegúrese de que el dispositivo Bluetooth esté conectado al altavoz. 	-
<ul style="list-style-type: none"> • El nivel de volumen del dispositivo móvil Bluetooth es demasiado bajo. Compruebe el nivel de volumen del dispositivo móvil Bluetooth. Compruebe el nivel de volumen del altavoz. 	-

A veces la música se corta o se retrasa

Solución	Consulte la página
<ul style="list-style-type: none"> • Asegúrese de que su conexión a Internet funciona correctamente. Si está compartiendo su red con otros usuarios o dispositivos, estos podrían estar usando la mayor parte de su ancho de banda (especialmente si están reproduciendo vídeos en tiempo real). 	6
<ul style="list-style-type: none"> • Asegúrese de que sus altavoces están dentro del rango de su red inalámbrica. 	47
<ul style="list-style-type: none"> • Asegúrese de que sus altavoces no están situados cerca de otros dispositivos electrónicos que podrían interferir con la conectividad inalámbrica (como, por ejemplo, los hornos de microondas, teléfonos inalámbricos, TV, etc.). 	47



Escucho un retardo al utilizar la entrada AUX con mi TV

Solución	Consulte la página
<ul style="list-style-type: none"> • Si se está conectando la entrada AUX con un decodificador de televisión por cable o satélite para disfrutar del audio de la TV a través de varios altavoces, es posible que escuche un retraso entre la imagen y el audio. Esto se debe a que el sistema HEOS debe almacenar el audio antes de enviarlo a los altavoces para que llegue a todos los altavoces al mismo tiempo. 	20
<ul style="list-style-type: none"> • Podrá evitar este retardo escuchando únicamente el altavoz que está directamente conectado al decodificador. 	-

Conexión a una red usando un dispositivo iOS

Solución	Consulte la página
<p>Este altavoz es compatible con el modo de configuración “WAC (Configuración de accesorio inalámbrico)” de Apple. El modo de configuración WAC le permite conectar su altavoz a su red sin que tenga que escribir el nombre y la contraseña de la red.</p> <ol style="list-style-type: none"> 1. Mantenga presionado - y los botones ► durante 3 segundos. 2. Vaya al menú Wi-Fi en los ajustes de su dispositivo iOS. 3. Seleccione “Denon Home 150” en “CONFIGURAR NUEVO ALTAVOZ AIRPLAY...” en la parte inferior de la lista. 4. Seleccione la red a la que desea conectar el altavoz y seleccione “Siguiente”. 5. Siga las instrucciones de la pantalla para completar la configuración. <p>El sistema HEOS permanecerá en el modo de configuración WAC durante 15 minutos. Si el dispositivo no se configura en 15 minutos, volverá a su conexión de red anterior. Pulse el botón ► si desea cancelar el modo de configuración WAC.</p> <p>El LED de estado parpadeará rápidamente 5 veces.</p>	-



Escucho distorsión cuando utilizo la entrada AUX

Solución	Consulte la página
<ul style="list-style-type: none"> Las señales de salida analógica procedentes de algunas fuentes pueden ser bastante fuertes. Si aumenta el nivel de entrada del dispositivo fuente, podría sobrecargar las entradas del altavoz. No es probable que esto cause daños, pero puede provocar un sonido distorsionado. Al principio, establezca el volumen de la fuente en un nivel medio - bajo para posteriormente subirlo según sea necesario. Si el sonido se escucha distorsionado, baje el control de volumen del dispositivo. 	-

Conexión a una red WPS

Solución	Consulte la página
<p>Si su enrutador inalámbrico es compatible con WPS (Wi-Fi Protected Setup™), puede conectar su altavoz opcionalmente a su red utilizando el método del “Pulsador” siguiendo estos pasos:</p> <p>Wi-Fi Protected Setup™ es una marca comercial de Wi-Fi Alliance.</p> <ol style="list-style-type: none"> 1. Pulse el botón WPS en su enrutador. 2. Antes de que transcurran 2 minutos, mantenga presionado el botón CONNECT en el panel trasero del altavoz durante 3 segundos. 3. El LED en la parte delantera del altavoz parpadeará en verde durante varios segundos mientras se conecta al router WPS. 4. Cuando se completa la conexión, el LED en la parte delantera del altavoz cambiará a azul estable. 	6



Restaurar su altavoz

Solución	Consulte la página
<p>Si restaura su altavoz se borrará la configuración de red inalámbrica, los ajustes de EQ y el nombre pero se conservará el software actual. Deberá utilizar "Ajustes" - "Agregar dispositivo" para reconectar el altavoz a su red doméstica antes de que pueda usarse.</p> <p>Para restablecer su altavoz, mantenga presionados los botones CONNECT y Bluetooth (📶) situados en el panel trasero del altavoz durante 5 segundos hasta que el LED frontal comience a parpadear en ámbar.</p>	-





Los botones no funcionan correctamente

Solución	Consulte la página
<ul style="list-style-type: none"> • No coloque ningún objeto sobre el producto. • Los elementos cerca de la parte superior del altavoz (cortinas, percheros de acero, etc.) pueden provocar la activación accidental del botón. • Instale el altavoz en un lugar donde no haya nada cerca. • Desenchufe el cable de alimentación antes de limpiar el panel superior. 	<p>-</p> <p>-</p> <p>-</p> <p>-</p>





Cuadro de LED de estado





Los LED del panel frontal cambian para indicar el estado actual del altavoz.

Estado del altavoz	Acción del LED	Descripción
Modo de espera completo	 (apagado)	La alimentación está apagada o el altavoz está en modo de espera completo. (ícono p. 49)
Modo de inicio rápido	 (fijo atenuado)	El altavoz está en modo de inicio rápido. (ícono p. 49)
Encendido	 (parpadeante)	El altavoz se está iniciando o se está conectando a la red.
	 (fijo)	El altavoz está conectado a la red.
	 (fijo)	El altavoz no puede establecer conexión con la red. Intente conectar de nuevo el altavoz.







Estado del altavoz	Acción del LED	Descripción
WPS	 (parpadeo rápido)	El altavoz se está conectando a la red a través de WPS.
	 (fijo durante 3 segundos)	El altavoz se conecta a la red a través de WPS.
	 (fijo durante 3 segundos)	WPS ha excedido el tiempo de espera.



Estado del altavoz	Acción del LED	Descripción
Bluetooth	 (dos parpadeos)	El altavoz se está emparejando a través de Bluetooth.
	 (un parpadeo)	El altavoz está emparejado a través de Bluetooth.
	 (fijo durante 3 segundos)	El altavoz no se pudo emparejar con el dispositivo Bluetooth. Intente volver a emparejarlo. (👉 p. 22)
Ajuste de volumen	 (parpadeo rápido)	Se está ajustando el volumen.
	 (parpadeo lento)	El altavoz está silenciado.



Estado del altavoz	Acción del LED	Descripción
Actualización de firmware	 (parpadeante)	El firmware se está actualizando.
	 (parpadeo lento; SIN atenuación)	Existe un error de firmware. Verifique su entorno de uso, vuelva a ejecutar la aplicación e intente volver a actualizar el firmware. (🔧 p. 45)
Error	 (fijo)	Se ha producido un error de configuración. Verifique su entorno de uso y siga el procedimiento correcto para reintentar la configuración. Si el error se repite, restablezca los valores de fábrica y vuelva a intentar la configuración. (🔧 p. 54)
	 (parpadeo rápido)	Se ha producido un error de hardware. Desenchufe el cable de alimentación, espere unos instantes y vuelva a enchufarlo.
Restablecimiento	 (parpadeante)	Se han restablecido los valores de fábrica.



Codecs y tipos de archivo compatibles

Frecuencia	Velocidad de muestreo	Extensión de archivo	Códec	Velocidad de bits
32/44,1/48 88,2/96/176,4 192 kHz	16/24 bits	wav	PCM	---
32 kHz 44,1 kHz 48 kHz	16 bits	mp3	MPEG-1 Audio Layer 3 CBR/VBR	32 – 320 kbps
32 kHz 44,1 kHz 48 kHz	16 bits	m4a aac	AAC-LC	48 – 320 kbps
32 kHz 44,1 kHz 48 kHz	16 bits	wma	wma9 CBR	CBR: 48 – 192 kbps
44,1/48 88,2/96/176,4 192 kHz	16/24 bits	flac	flac	---
44,1/48 88,2/96/176,4 192 kHz	16/24 bits	m4a	ALAC	---
2,8/5,6 MHz	1 bit	dff dsf	DSDIFF DSF	---

NOTA

- No se admiten archivos protegidos por DRM como Fairplay DRM de Apple.
- Si selecciona una fuente de música con una alta velocidad de bits o una alta resolución, se establece al nivel adecuado por códec antes de emitirse.
- El descodificador ALAC se distribuye con licencia Apache, versión 2.0 (<http://www.apache.org/licenses/LICENSE-2.0>)



Especificaciones

LAN inalámbrica

Tipo de red:

Conforme a IEEE 802.11a/b/g/n/ac

Rango de frecuencias utilizado:

2,4 GHz, 5 GHz

General

Temperatura de funcionamiento:

41 °F – 95 °F (5 °C – 35 °C)

Fuente de alimentación:

CA 100 - 240 V, 50/60 Hz (para modelos de Europa)

CA 100 - 120 V, 50/60 Hz (para modelos de Norteamérica)

Consumo de energía:

20 W

Consumo de energía en el Modo de inicio rápido:

2,2 W (Wi-Fi 2,4 GHz)

2,2 W (Wi-Fi 5 GHz)

1,8 W (Ethernet)

2,2 W (USB con Wi-Fi)

1,6 W (Bluetooth)

Consumo de energía en modo de espera completo:

0,3 W

Entrada analógica máxima:

2 Vrms



Dimensiones

Unidad: pulgada (mm)

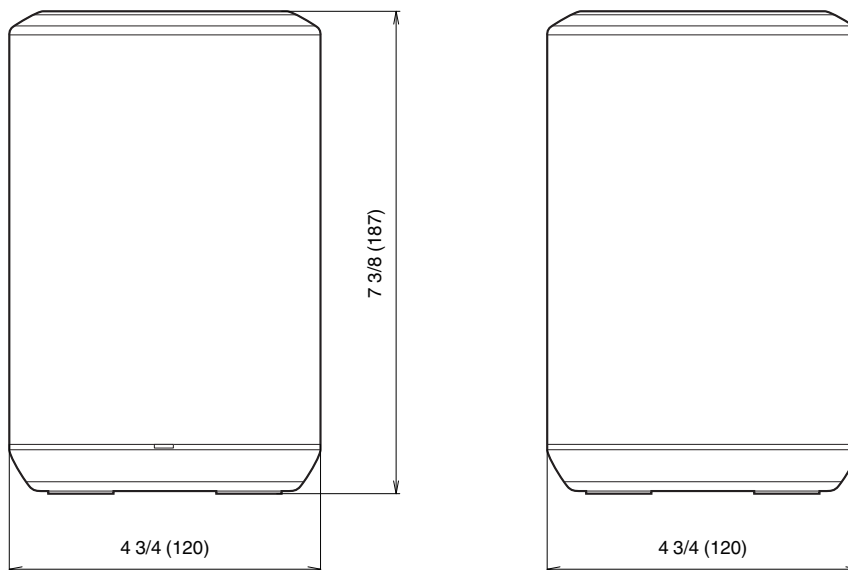

Peso: 3 libras, 12 onzas (1,7 kg)

Con el propósito de introducir mejoras, las especificaciones y el diseño del equipo están sujetos a cambios sin previo aviso.



Información

Marcas



Google Play y el logotipo de Google Play son marcas comerciales de Google LLC.



Apple, el logotipo de Apple, iPhone e iPad son marcas comerciales de Apple Inc., registradas en Estados Unidos de América y otros países y regiones. App Store es una marca de servicio de Apple Inc.



El logotipo Wi-Fi Protected setup™ es una marca de Wi-Fi Alliance.



La marca denominativa y los logotipos de Bluetooth® son marcas comerciales registradas propiedad de Bluetooth SIG, Inc. y cualquier uso de tales marcas por D&M Holdings Inc. está bajo licencia. Otras marcas registradas y nombres comerciales son de sus respectivos propietarios.





Apple, AirPlay, iPad, iPad Air, iPad Pro and iPhone are trademarks of Apple Inc., registered in the U.S. and other countries.

The trademark "iPhone" is used in Japan with a license from Aiphone K.K.

Use of the Works with Apple badge means that an accessory has been designed to work specifically with the technology identified in the badge and has been certified by the developer to meet Apple performance standards.



Licencia

■ Información acerca de la licencia del software empleado en la unidad

Acerca de las licencias GPL (siglas en inglés de Licencia Pública General de GNU) y LGPL (siglas en inglés de Licencia Pública General Reducida de GNU)

En este producto se emplea software propio con licencia GPL/LGPL y software desarrollado por otros fabricantes.

Una vez adquirido este producto, puede conseguir, modificar o distribuir el código fuente del software con licencia GPL/LGPL que se emplea en el producto.

Denon proporciona el código fuente basado en las licencias GPL y LPGL a su coste real previa solicitud a nuestro centro de atención al cliente. Sin embargo, tenga en cuenta que no proporcionamos ninguna garantía en relación con el código fuente. Sepa también que no ofrecemos asistencia para el contenido del código fuente.

En esta sección se describe la licencia de software que se usa en esta unidad. Para mantener el contenido correcto, se usa el original (inglés).

□ GPL

Open Source Used	Version
bridge-utils	1.6
busybox	1.27.2
ebtables	2.0.10-4
Linux kernel	4.4.22
mtd-utils	2.0.2
ntfs-3g_ntfsprogs	2017.3.23
u-boot	2018.07
cifs-utils	6.7
wireless-tools	2.9
ffmpeg	3.4.4

□ LGPL

Open Source Used	Versión
ffmpeg	3.4.4
libmms	0.6.4
taglib	1.11.1
libglib2	2.54.2
libnl	3.4.0
glibc	2.28
glib	2-2.54.2
ntfs-3g_ntfsprogs	2017.3.23



❑ Mbed TLS-2.7.5

Apache License

Version 2.0, January 2004

<http://www.apache.org/licenses/>

TERMS AND CONDITIONS FOR USE, REPRODUCTION, AND DISTRIBUTION

1. Definitions.

"License" shall mean the terms and conditions for use, reproduction, and distribution as defined by Sections 1 through 9 of this document.

"Licensor" shall mean the copyright owner or entity authorized by the copyright owner that is granting the License.

"Legal Entity" shall mean the union of the acting entity and all other entities that control, are controlled by, or are under common control with that entity. For the purposes of this definition, "control" means (i) the power, direct or indirect, to cause the direction or management of such entity, whether by contract or otherwise, or (ii) ownership of fifty percent (50 %) or more of the outstanding shares, or (iii) beneficial ownership of such entity.

"You" (or "Your") shall mean an individual or Legal Entity exercising permissions granted by this License.

"Source" form shall mean the preferred form for making modifications, including but not limited to software source code, documentation source, and configuration files.

"Object" form shall mean any form resulting from mechanical transformation or translation of a Source form, including but not limited to compiled object code, generated documentation, and conversions to other media types.

"Work" shall mean the work of authorship, whether in Source or Object form, made available under the License, as indicated by a copyright notice that is included in or attached to the work (an example is provided in the Appendix below).

"Derivative Works" shall mean any work, whether in Source or Object form, that is based on (or derived from) the Work and for which the editorial revisions, annotations, elaborations, or other modifications represent, as a whole, an original work of authorship. For the purposes of this License, Derivative Works shall not include works that remain separable from, or merely link (or bind by name) to the interfaces of, the Work and Derivative Works thereof.

"Contribution" shall mean any work of authorship, including the original version of the Work and any modifications or additions to that Work or Derivative Works thereof, that is intentionally submitted to Licensor for inclusion in the Work by the copyright owner or by an individual or Legal Entity authorized to submit on behalf of the copyright owner. For the purposes of this definition, "submitted" means any form of electronic, verbal, or written communication sent to the Licensor or its representatives, including but not limited to communication on electronic mailing lists, source code control systems, and issue tracking systems that are managed by, or on behalf of, the Licensor for the purpose of discussing and improving the Work, but excluding communication that is conspicuously marked or otherwise designated in writing by the copyright owner as "Not a Contribution."

"Contributor" shall mean Licensor and any individual or Legal Entity on behalf of whom a Contribution has been received by Licensor and subsequently incorporated within the Work.



2. Grant of Copyright License. Subject to the terms and conditions of this License, each Contributor hereby grants to You a perpetual, worldwide, non-exclusive, no-charge, royalty-free, irrevocable copyright license to reproduce, prepare Derivative Works of, publicly display, publicly perform, sublicense, and distribute the Work and such Derivative Works in Source or Object form.
3. Grant of Patent License. Subject to the terms and conditions of this License, each Contributor hereby grants to You a perpetual, worldwide, non-exclusive, no-charge, royalty-free, irrevocable (except as stated in this section) patent license to make, have made, use, offer to sell, sell, import, and otherwise transfer the Work, where such license applies only to those patent claims licensable by such Contributor that are necessarily infringed by their Contribution(s) alone or by combination of their Contribution(s) with the Work to which such Contribution(s) was submitted. If You institute patent litigation against any entity (including a cross-claim or counterclaim in a lawsuit) alleging that the Work or a Contribution incorporated within the Work constitutes direct or contributory patent infringement, then any patent licenses granted to You under this License for that Work shall terminate as of the date such litigation is filed.
4. Redistribution. You may reproduce and distribute copies of the Work or Derivative Works thereof in any medium, with or without modifications, and in Source or Object form, provided that You meet the following conditions:
 - (a) You must give any other recipients of the Work or Derivative Works a copy of this License; and
 - (b) You must cause any modified files to carry prominent notices stating that You changed the files; and
 - (c) You must retain, in the Source form of any Derivative Works that You distribute, all copyright, patent, trademark, and attribution notices from the Source form of the Work, excluding those notices that do not pertain to any part of the Derivative Works; and
 - (d) If the Work includes a "NOTICE" text file as part of its distribution, then any Derivative Works that You distribute must include a readable copy of the attribution notices contained within such NOTICE file, excluding those notices that do not pertain to any part of the Derivative Works, in at least one of the following places: within a NOTICE text file distributed as part of the Derivative Works; within the Source form or documentation, if provided along with the Derivative Works; or, within a display generated by the Derivative Works, if and wherever such third-party notices normally appear. The contents of the NOTICE file are for informational purposes only and do not modify the License. You may add Your own attribution notices within Derivative Works that You distribute, alongside or as an addendum to the NOTICE text from the Work, provided that such additional attribution notices cannot be construed as modifying the License.You may add Your own copyright statement to Your modifications and may provide additional or different license terms and conditions for use, reproduction, or distribution of Your modifications, or for any such Derivative Works as a whole, provided Your use, reproduction, and distribution of the Work otherwise complies with the conditions stated in this License.
5. Submission of Contributions. Unless You explicitly state otherwise, any Contribution intentionally submitted for inclusion in the Work by You to the Licensor shall be under the terms and conditions of this License, without any additional terms or conditions. Notwithstanding the above, nothing herein shall supersede or modify the terms of any separate license agreement you may have executed with Licensor regarding such Contributions.



6. Trademarks. This License does not grant permission to use the trade names, trademarks, service marks, or product names of the Licensor, except as required for reasonable and customary use in describing the origin of the Work and reproducing the content of the NOTICE file.
7. Disclaimer of Warranty. Unless required by applicable law or agreed to in writing, Licensor provides the Work (and each Contributor provides its Contributions) on an "AS IS" BASIS, WITHOUT WARRANTIES OR CONDITIONS OF ANY KIND, either express or implied, including, without limitation, any warranties or conditions of TITLE, NON-INFRINGEMENT, MERCHANTABILITY, or FITNESS FOR A PARTICULAR PURPOSE. You are solely responsible for determining the appropriateness of using or redistributing the Work and assume any risks associated with Your exercise of permissions under this License.
8. Limitation of Liability. In no event and under no legal theory, whether in tort (including negligence), contract, or otherwise, unless required by applicable law (such as deliberate and grossly negligent acts) or agreed to in writing, shall any Contributor be liable to You for damages, including any direct, indirect, special, incidental, or consequential damages of any character arising as a result of this License or out of the use or inability to use the Work (including but not limited to damages for loss of goodwill, work stoppage, computer failure or malfunction, or any and all other commercial damages or losses), even if such Contributor has been advised of the possibility of such damages.

9. Accepting Warranty or Additional Liability. While redistributing the Work or Derivative Works thereof, You may choose to offer, and charge a fee for, acceptance of support, warranty, indemnity, or other liability obligations and/or rights consistent with this License. However, in accepting such obligations, You may act only on Your own behalf and on Your sole responsibility, not on behalf of any other Contributor, and only if You agree to indemnify, defend, and hold each Contributor harmless for any liability incurred by, or claims asserted against, such Contributor by reason of your accepting any such warranty or additional liability.

END OF TERMS AND CONDITIONS

APPENDIX: How to apply the Apache License to your work.

To apply the Apache License to your work, attach the following boilerplate notice, with the fields enclosed by brackets "[]" replaced with your own identifying information. (Don't include the brackets!) The text should be enclosed in the appropriate comment syntax for the file format. We also recommend that a file or class name and description of purpose be included on the same "printed page" as the copyright notice for easier identification within third-party archives.

Copyright [yyyy] [name of copyright owner]

Licensed under the Apache License, Version 2.0 (the "License"); you may not use this file except in compliance with the License. You may obtain a copy of the License at

<http://www.apache.org/licenses/LICENSE-2.0>

Unless required by applicable law or agreed to in writing, software distributed under the License is distributed on an "AS IS" BASIS, WITHOUT WARRANTIES OR CONDITIONS OF ANY KIND, either express or implied. See the License for the specific language governing permissions and limitations under the License.



❑ mDNSResponder-765.50.9

The majority of the source code in the mDNSResponder project is licensed under the terms of the Apache License, Version 2.0, available from:

<<http://www.apache.org/licenses/LICENSE-2.0>>

To accommodate license compatibility with the widest possible range of client code licenses, the shared library code, which is linked at runtime into the same address space as the client using it, is licensed under the terms of the "Three-Clause BSD License".

The Linux Name Service Switch code, contributed by National ICT Australia Ltd (NICTA) is licensed under the terms of the NICTA Public Software Licence (which is substantially similar to the "Three-Clause BSD License", with some additional language pertaining to Australian law).

❑ OpenAvnu-2018-07-30

Copyright (c) 2012, Intel Corporation

All rights reserved.

Redistribution and use in source and binary forms, with or without modification, are permitted provided that the following conditions are met:

1. Redistributions of source code must retain the above copyright notice, this list of conditions and the following disclaimer.
2. Redistributions in binary form must reproduce the above copyright notice, this list of conditions and the following disclaimer in the documentation and/or other materials provided with the distribution.
3. Neither the name of the Intel Corporation nor the names of its contributors may be used to endorse or promote products derived from this software without specific prior written permission.

THIS SOFTWARE IS PROVIDED BY THE COPYRIGHT HOLDERS AND CONTRIBUTORS "AS IS" AND ANY EXPRESS OR IMPLIED WARRANTIES, INCLUDING, BUT NOT LIMITED TO, THE IMPLIED WARRANTIES OF MERCHANTABILITY AND FITNESS FOR A PARTICULAR PURPOSE ARE DISCLAIMED. IN NO EVENT SHALL THE COPYRIGHT OWNER OR CONTRIBUTORS BE LIABLE FOR ANY DIRECT, INDIRECT, INCIDENTAL, SPECIAL, EXEMPLARY, OR CONSEQUENTIAL DAMAGES (INCLUDING, BUT NOT LIMITED TO, PROCUREMENT OF SUBSTITUTE GOODS OR SERVICES; LOSS OF USE, DATA, OR PROFITS; OR BUSINESS INTERRUPTION) HOWEVER CAUSED AND ON ANY THEORY OF LIABILITY, WHETHER IN CONTRACT, STRICT LIABILITY, OR TORT (INCLUDING NEGLIGENCE OR OTHERWISE) ARISING IN ANY WAY OUT OF THE USE OF THIS SOFTWARE, EVEN IF ADVISED OF THE POSSIBILITY OF SUCH DAMAGE.



❑ fmt-5.1.0

Copyright (c) 2012 - 2016, Victor Zverovich

All rights reserved.

Redistribution and use in source and binary forms, with or without modification, are permitted provided that the following conditions are met:

1. Redistributions of source code must retain the above copyright notice, this list of conditions and the following disclaimer.
2. Redistributions in binary form must reproduce the above copyright notice, this list of conditions and the following disclaimer in the documentation and/or other materials provided with the distribution.

THIS SOFTWARE IS PROVIDED BY THE COPYRIGHT HOLDERS AND CONTRIBUTORS "AS IS" AND ANY EXPRESS OR IMPLIED WARRANTIES, INCLUDING, BUT NOT LIMITED TO, THE IMPLIED WARRANTIES OF MERCHANTABILITY AND FITNESS FOR A PARTICULAR PURPOSE ARE DISCLAIMED. IN NO EVENT SHALL THE COPYRIGHT OWNER OR CONTRIBUTORS BE LIABLE FOR ANY DIRECT, INDIRECT, INCIDENTAL, SPECIAL, EXEMPLARY, OR CONSEQUENTIAL DAMAGES (INCLUDING, BUT NOT LIMITED TO, PROCUREMENT OF SUBSTITUTE GOODS OR SERVICES; LOSS OF USE, DATA, OR PROFITS; OR BUSINESS INTERRUPTION) HOWEVER CAUSED AND ON ANY THEORY OF LIABILITY, WHETHER IN CONTRACT, STRICT LIABILITY, OR TORT (INCLUDING NEGLIGENCE OR OTHERWISE) ARISING IN ANY WAY OUT OF THE USE OF THIS SOFTWARE, EVEN IF ADVISED OF THE POSSIBILITY OF SUCH DAMAGE.

❑ libtar-1.2.20

Copyright (c) 1998-2003 University of Illinois Board of Trustees

Copyright (c) 1998-2003 Mark D. Roth

All rights reserved.

Developed by: Campus Information Technologies and Educational Services, University of Illinois at Urbana-Champaign

Permission is hereby granted, free of charge, to any person obtaining a copy of this software and associated documentation files (the "Software"), to deal with the Software without restriction, including without limitation the rights to use, copy, modify, merge, publish, distribute, sublicense, and/or sell copies of the Software, and to permit persons to whom the Software is furnished to do so, subject to the following conditions:

- * Redistributions of source code must retain the above copyright notice, this list of conditions and the following disclaimers.
- * Redistributions in binary form must reproduce the above copyright notice, this list of conditions and the following disclaimers in the documentation and/or other materials provided with the distribution.
- * Neither the names of Campus Information Technologies and Educational Services, University of Illinois at Urbana-Champaign, nor the names of its contributors may be used to endorse or promote products derived from this Software without specific prior written permission.



THE SOFTWARE IS PROVIDED "AS IS", WITHOUT WARRANTY OF ANY KIND, EXPRESS OR IMPLIED, INCLUDING BUT NOT LIMITED TO THE WARRANTIES OF MERCHANTABILITY, FITNESS FOR A PARTICULAR PURPOSE AND NONINFRINGEMENT. IN NO EVENT SHALL THE CONTRIBUTORS OR COPYRIGHT HOLDERS BE LIABLE FOR ANY CLAIM, DAMAGES OR OTHER LIABILITY, WHETHER IN AN ACTION OF CONTRACT, TORT OR OTHERWISE, ARISING FROM, OUT OF OR IN CONNECTION WITH THE SOFTWARE OR THE USE OR OTHER DEALINGS WITH THE SOFTWARE.

❑ ARM Trusted Firmware-1.21

Copyright (c) 2013-2015, ARM Limited and Contributors. All rights reserved.

Redistribution and use in source and binary forms, with or without modification, are permitted provided that the following conditions are met:

- * Redistributions of source code must retain the above copyright notice, this list of conditions and the following disclaimer.
- * Redistributions in binary form must reproduce the above copyright notice, this list of conditions and the following disclaimer in the documentation and/or other materials provided with the distribution.
- * Neither the name of ARM nor the names of its contributors may be used to endorse or promote products derived from this software without specific prior written permission.

THIS SOFTWARE IS PROVIDED BY THE COPYRIGHT HOLDERS AND CONTRIBUTORS "AS IS" AND ANY EXPRESS OR IMPLIED WARRANTIES, INCLUDING, BUT NOT LIMITED TO, THE IMPLIED WARRANTIES OF MERCHANTABILITY AND FITNESS FOR A PARTICULAR PURPOSE ARE DISCLAIMED. IN NO EVENT SHALL THE COPYRIGHT HOLDER OR CONTRIBUTORS BE LIABLE FOR ANY DIRECT, INDIRECT, INCIDENTAL, SPECIAL, EXEMPLARY, OR CONSEQUENTIAL DAMAGES (INCLUDING, BUT NOT LIMITED TO, PROCUREMENT OF SUBSTITUTE GOODS OR SERVICES; LOSS OF USE, DATA, OR PROFITS; OR BUSINESS INTERRUPTION) HOWEVER CAUSED AND ON ANY THEORY OF LIABILITY, WHETHER IN CONTRACT, STRICT LIABILITY, OR TORT (INCLUDING NEGLIGENCE OR OTHERWISE) ARISING IN ANY WAY OUT OF THE USE OF THIS SOFTWARE, EVEN IF ADVISED OF THE POSSIBILITY OF SUCH DAMAGE.



❑ googletest-v1.8.0 Protocol Buffers-v3.6.0

Copyright 2008, Google Inc.
All rights reserved.

Redistribution and use in source and binary forms, with or without modification, are permitted provided that the following conditions are met:

- * Redistributions of source code must retain the above copyright notice, this list of conditions and the following disclaimer.
- * Redistributions in binary form must reproduce the above copyright notice, this list of conditions and the following disclaimer in the documentation and/or other materials provided with the distribution.
- * Neither the name of Google Inc. nor the names of its contributors may be used to endorse or promote products derived from this software without specific prior written permission.

THIS SOFTWARE IS PROVIDED BY THE COPYRIGHT HOLDERS AND CONTRIBUTORS AS IS AND ANY EXPRESS OR IMPLIED WARRANTIES, INCLUDING, BUT NOT LIMITED TO, THE IMPLIED WARRANTIES OF MERCHANTABILITY AND FITNESS FOR A PARTICULAR PURPOSE ARE DISCLAIMED. IN NO EVENT SHALL THE COPYRIGHT OWNER OR CONTRIBUTORS BE LIABLE FOR ANY DIRECT, INDIRECT, INCIDENTAL, SPECIAL, EXEMPLARY, OR CONSEQUENTIAL DAMAGES (INCLUDING, BUT NOT LIMITED TO, PROCUREMENT OF SUBSTITUTE GOODS OR SERVICES; LOSS OF USE, DATA, OR PROFITS; OR BUSINESS INTERRUPTION) HOWEVER CAUSED AND ON ANY THEORY OF LIABILITY, WHETHER IN CONTRACT, STRICT LIABILITY, OR TORT (INCLUDING NEGLIGENCE OR OTHERWISE) ARISING IN ANY WAY OUT OF THE USE OF THIS SOFTWARE, EVEN IF ADVISED OF THE POSSIBILITY OF SUCH DAMAGE.

❑ hostapd-2.6 wpa_supplicant-2.6

Copyright (c) 2002-2016, Jouni Malinen <j@w1.fi> and contributors
All Rights Reserved.

These programs are licensed under the BSD license (the one with advertisement clause removed).

If you are submitting changes to the project, please see CONTRIBUTIONS file for more instructions.

This package may include either wpa_supplicant, hostapd, or both. See README file respective subdirectories (wpa_supplicant/README or hostapd/README) for more details.

Source code files were moved around in v0.6.x releases and compared to earlier releases, the programs are now built by first going to a subdirectory (wpa_supplicant or hostapd) and creating build configuration (.config) and running 'make' there (for Linux/BSD/cygwin builds).

License

This software may be distributed, used, and modified under the terms of BSD license:

Redistribution and use in source and binary forms, with or without modification, are permitted provided that the following conditions are met:

1. Redistributions of source code must retain the above copyright notice, this list of conditions and the following disclaimer.
2. Redistributions in binary form must reproduce the above copyright notice, this list of conditions and the following disclaimer in the documentation and/or other materials provided with the distribution.



- Neither the name(s) of the above-listed copyright holder(s) nor the names of its contributors may be used to endorse or promote products derived from this software without specific prior written permission.

THIS SOFTWARE IS PROVIDED BY THE COPYRIGHT HOLDERS AND CONTRIBUTORS AS IS AND ANY EXPRESS OR IMPLIED WARRANTIES, INCLUDING, BUT NOT LIMITED TO, THE IMPLIED WARRANTIES OF MERCHANTABILITY AND FITNESS FOR A PARTICULAR PURPOSE ARE DISCLAIMED. IN NO EVENT SHALL THE COPYRIGHT OWNER OR CONTRIBUTORS BE LIABLE FOR ANY DIRECT, INDIRECT, INCIDENTAL, SPECIAL, EXEMPLARY, OR CONSEQUENTIAL DAMAGES (INCLUDING, BUT NOT LIMITED TO, PROCUREMENT OF SUBSTITUTE GOODS OR SERVICES; LOSS OF USE, DATA, OR PROFITS; OR BUSINESS INTERRUPTION) HOWEVER CAUSED AND ON ANY THEORY OF LIABILITY, WHETHER IN CONTRACT, STRICT LIABILITY, OR TORT (INCLUDING NEGLIGENCE OR OTHERWISE) ARISING IN ANY WAY OUT OF THE USE OF THIS SOFTWARE, EVEN IF ADVISED OF THE POSSIBILITY OF SUCH DAMAGE.

❏ libpcap-1.8.1

License: BSD

Redistribution and use in source and binary forms, with or without modification, are permitted provided that the following conditions are met:

- Redistributions of source code must retain the above copyright notice, this list of conditions and the following disclaimer.
- Redistributions in binary form must reproduce the above copyright notice, this list of conditions and the following disclaimer in the documentation and/or other materials provided with the distribution.
- The names of the authors may not be used to endorse or promote products derived from this software without specific prior written permission.

THIS SOFTWARE IS PROVIDED "AS IS" AND WITHOUT ANY EXPRESS OR IMPLIED WARRANTIES, INCLUDING, WITHOUT LIMITATION, THE IMPLIED WARRANTIES OF MERCHANTABILITY AND FITNESS FOR A PARTICULAR PURPOSE.



❑ PCRE-8.41

PCRE LICENCE

PCRE is a library of functions to support regular expressions whose syntax and semantics are as close as possible to those of the Perl 5 language.

Release 8 of PCRE is distributed under the terms of the "BSD" licence, as specified below. The documentation for PCRE, supplied in the "doc" directory, is distributed under the same terms as the software itself. The data in the testdata directory is not copyrighted and is in the public domain.

The basic library functions are written in C and are freestanding. Also included in the distribution is a set of C++ wrapper functions, and a just-in-time compiler that can be used to optimize pattern matching. These are both optional features that can be omitted when the library is built.

THE BASIC LIBRARY FUNCTIONS

Written by: Philip Hazel

Email local part: ph10

Email domain: cam.ac.uk

University of Cambridge Computing Service, Cambridge, England.

Copyright (c) 1997-2017 University of Cambridge

All rights reserved.

PCRE JUST-IN-TIME COMPILATION SUPPORT

Written by: Zoltan Herczeg

Email local part: hzmester

Email domain: freemail.hu

Copyright(c) 2010-2017 Zoltan Herczeg

All rights reserved.

STACK-LESS JUST-IN-TIME COMPILER

Written by: Zoltan Herczeg

Email local part: hzmester

Email domain: freemail.hu

Copyright(c) 2009-2017 Zoltan Herczeg

All rights reserved.

THE C++ WRAPPER FUNCTIONS

Contributed by: Google Inc.

Copyright (c) 2007-2012, Google Inc.

All rights reserved.

THE "BSD" LICENCE



Redistribution and use in source and binary forms, with or without modification, are permitted provided that the following conditions are met:

- * Redistributions of source code must retain the above copyright notice, this list of conditions and the following disclaimer.
- * Redistributions in binary form must reproduce the above copyright notice, this list of conditions and the following disclaimer in the documentation and/or other materials provided with the distribution.
- * Neither the name of the University of Cambridge nor the name of Google Inc. nor the names of their contributors may be used to endorse or promote products derived from this software without specific prior written permission.

THIS SOFTWARE IS PROVIDED BY THE COPYRIGHT HOLDERS AND CONTRIBUTORS "AS IS" AND ANY EXPRESS OR IMPLIED WARRANTIES, INCLUDING, BUT NOT LIMITED TO, THE IMPLIED WARRANTIES OF MERCHANTABILITY AND FITNESS FOR A PARTICULAR PURPOSE ARE DISCLAIMED. IN NO EVENT SHALL THE COPYRIGHT OWNER OR CONTRIBUTORS BE LIABLE FOR ANY DIRECT, INDIRECT, INCIDENTAL, SPECIAL, EXEMPLARY, OR CONSEQUENTIAL DAMAGES (INCLUDING, BUT NOT LIMITED TO, PROCUREMENT OF SUBSTITUTE GOODS OR SERVICES; LOSS OF USE, DATA, OR PROFITS; OR BUSINESS INTERRUPTION) HOWEVER CAUSED AND ON ANY THEORY OF LIABILITY, WHETHER IN CONTRACT, STRICT LIABILITY, OR TORT (INCLUDING NEGLIGENCE OR OTHERWISE) ARISING IN ANY WAY OUT OF THE USE OF THIS SOFTWARE, EVEN IF ADVISED OF THE POSSIBILITY OF SUCH DAMAGE.

End

❏ Boost-1.66.0

Boost Software License - Version 1.0 - August 17th, 2003

Permission is hereby granted, free of charge, to any person or organization obtaining a copy of the software and accompanying documentation covered by this license (the "Software") to use, reproduce, display, distribute, execute, and transmit the Software, and to prepare derivative works of the Software, and to permit third-parties to whom the Software is furnished to do so, all subject to the following:

The copyright notices in the Software and this entire statement, including the above license grant, this restriction and the following disclaimer, must be included in all copies of the Software, in whole or in part, and all derivative works of the Software, unless such copies or derivative works are solely in the form of machine-executable object code generated by a source language processor.

THE SOFTWARE IS PROVIDED "AS IS", WITHOUT WARRANTY OF ANY KIND, EXPRESS OR IMPLIED, INCLUDING BUT NOT LIMITED TO THE WARRANTIES OF MERCHANTABILITY, FITNESS FOR A PARTICULAR PURPOSE, TITLE AND NON-INFRINGEMENT. IN NO EVENT SHALL THE COPYRIGHT HOLDERS OR ANYONE DISTRIBUTING THE SOFTWARE BE LIABLE FOR ANY DAMAGES OR OTHER LIABILITY, WHETHER IN CONTRACT, TORT OR OTHERWISE, ARISING FROM, OUT OF OR IN CONNECTION WITH THE SOFTWARE OR THE USE OR OTHER DEALINGS IN THE SOFTWARE.



❑ libcurl-7.61.1

Copyright (c) 1996 - 2018, Daniel Stenberg, <daniel@haxx.se>, and many contributors, see the THANKS file.

All rights reserved.

Permission to use, copy, modify, and distribute this software for any purpose with or without fee is hereby granted, provided that the above copyright notice and this permission notice appear in all copies.

THE SOFTWARE IS PROVIDED "AS IS", WITHOUT WARRANTY OF ANY KIND, EXPRESS OR IMPLIED, INCLUDING BUT NOT LIMITED TO THE WARRANTIES OF MERCHANTABILITY, FITNESS FOR A PARTICULAR PURPOSE AND NONINFRINGEMENT OF THIRD PARTY RIGHTS. IN NO EVENT SHALL THE AUTHORS OR COPYRIGHT HOLDERS BE LIABLE FOR ANY CLAIM, DAMAGES OR OTHER LIABILITY, WHETHER IN AN ACTION OF CONTRACT, TORT OR OTHERWISE, ARISING FROM, OUT OF OR IN CONNECTION WITH THE SOFTWARE OR THE USE OR OTHER DEALINGS IN THE SOFTWARE.

❑ libjpeg-turbo-1.5.2

libjpeg-turbo is covered by three compatible BSD-style open source licenses:

- The IJG (Independent JPEG Group) License, which is listed in README.iyg

This license applies to the libjpeg API library and associated programs (any code inherited from libjpeg, and any modifications to that code.)

- The Modified (3-clause) BSD License, which is listed below

This license covers the TurboJPEG API library and associated programs.

- The zlib License, which is listed below

This license is a subset of the other two, and it covers the libjpeg-turbo SIMD extensions.

Complying with the libjpeg-turbo Licenses

=====

This section provides a roll-up of the libjpeg-turbo licensing terms, to the best of our understanding.

1. If you are distributing a modified version of the libjpeg-turbo source, then:
 1. You cannot alter or remove any existing copyright or license notices from the source.

****Origin****

 - Clause 1 of the IJG License
 - Clause 1 of the Modified BSD License
 - Clauses 1 and 3 of the zlib License



2. You must add your own copyright notice to the header of each source file you modified, so others can tell that you modified that file (if there is not an existing copyright header in that file, then you can simply add a notice stating that you modified the file.)
 - **Origin**
 - Clause 1 of the IJG License
 - Clause 2 of the zlib License
3. You must include the IJG README file, and you must not alter any of the copyright or license text in that file.
 - **Origin**
 - Clause 1 of the IJG License
2. If you are distributing only libjpeg-turbo binaries without the source, or if you are distributing an application that statically links with libjpeg-turbo, then:
 1. Your product documentation must include a message stating:
 - This software is based in part on the work of the Independent JPEG Group.
 - **Origin**
 - Clause 2 of the IJG license
 2. If your binary distribution includes or uses the TurboJPEG API, then your product documentation must include the text of the Modified BSD License.
 - **Origin**
 - Clause 2 of the Modified BSD License

3. You cannot use the name of the IJG or The libjpeg-turbo Project or the contributors thereof in advertising, publicity, etc.
 - **Origin**
 - IJG License
 - Clause 3 of the Modified BSD License
4. The IJG and The libjpeg-turbo Project do not warrant libjpeg-turbo to be free of defects, nor do we accept any liability for undesirable consequences resulting from your use of the software.
 - **Origin**
 - IJG License
 - Modified BSD License
 - zlib License

The Modified (3-clause) BSD License

=====

Copyright (C)¥<YEAR¥> ¥<AUTHOR¥>. All Rights Reserved.

Redistribution and use in source and binary forms, with or without modification, are permitted provided that the following conditions are met:

- Redistributions of source code must retain the above copyright notice, this list of conditions and the following disclaimer.
- Redistributions in binary form must reproduce the above copyright notice, this list of conditions and the following disclaimer in the documentation and/or other materials provided with the distribution.
- Neither the name of the libjpeg-turbo Project nor the names of its contributors may be used to endorse or promote products derived from this software without specific prior written permission.



THIS SOFTWARE IS PROVIDED BY THE COPYRIGHT HOLDERS AND CONTRIBUTORS "AS IS", AND ANY EXPRESS OR IMPLIED WARRANTIES, INCLUDING, BUT NOT LIMITED TO, THE IMPLIED WARRANTIES OF MERCHANTABILITY AND FITNESS FOR A PARTICULAR PURPOSE ARE DISCLAIMED. IN NO EVENT SHALL THE COPYRIGHT HOLDERS OR CONTRIBUTORS BE LIABLE FOR ANY DIRECT, INDIRECT, INCIDENTAL, SPECIAL, EXEMPLARY, OR CONSEQUENTIAL DAMAGES (INCLUDING, BUT NOT LIMITED TO, PROCUREMENT OF SUBSTITUTE GOODS OR SERVICES; LOSS OF USE, DATA, OR PROFITS; OR BUSINESS INTERRUPTION) HOWEVER CAUSED AND ON ANY THEORY OF LIABILITY, WHETHER IN CONTRACT, STRICT LIABILITY, OR TORT (INCLUDING NEGLIGENCE OR OTHERWISE) ARISING IN ANY WAY OUT OF THE USE OF THIS SOFTWARE, EVEN IF ADVISED OF THE POSSIBILITY OF SUCH DAMAGE.

The zlib License

=====

Copyright (C) ¥<YEAR¥>, ¥<AUTHOR¥>.

This software is provided 'as-is', without any express or implied warranty. In no event will the authors be held liable for any damages arising from the use of this software.

Permission is granted to anyone to use this software for any purpose, including commercial applications, and to alter it and redistribute it freely, subject to the following restrictions:

1. The origin of this software must not be misrepresented; you must not claim that you wrote the original software. If you use this software in a product, an acknowledgment in the product documentation would be appreciated but is not required.
2. Altered source versions must be plainly marked as such, and must not be misrepresented as being the original software.
3. This notice may not be removed or altered from any source distribution.



❑ iw-4.9

Copyright (c) 2007, 2008 Johannes Berg

Copyright (c) 2007 Andy Lutomirski

Copyright (c) 2007 Mike Kershaw

Copyright (c) 2008-2009 Luis R. Rodriguez

Permission to use, copy, modify, and/or distribute this software for any purpose with or without fee is hereby granted, provided that the above copyright notice and this permission notice appear in all copies.

THE SOFTWARE IS PROVIDED "AS IS" AND THE AUTHOR DISCLAIMS ALL WARRANTIES WITH REGARD TO THIS SOFTWARE INCLUDING ALL IMPLIED WARRANTIES OF MERCHANTABILITY AND FITNESS. IN NO EVENT SHALL THE AUTHOR BE LIABLE FOR ANY SPECIAL, DIRECT, INDIRECT, OR CONSEQUENTIAL DAMAGES OR ANY DAMAGES WHATSOEVER RESULTING FROM LOSS OF USE, DATA OR PROFITS, WHETHER IN AN ACTION OF CONTRACT, NEGLIGENCE OR OTHER TORTIOUS ACTION, ARISING OUT OF OR IN CONNECTION WITH THE USE OR PERFORMANCE OF THIS SOFTWARE.

❑ taglib-1.11.1

MOZILLA PUBLIC LICENSE

Version 1.1

1. Definitions.

1.0.1. "Commercial Use" means distribution or otherwise making the Covered Code available to a third party.

1.1. "Contributor" means each entity that creates or contributes to the creation of Modifications.

1.2. "Contributor Version" means the combination of the Original Code, prior Modifications used by a Contributor, and the Modifications made by that particular Contributor.

1.3. "Covered Code" means the Original Code or Modifications or the combination of the Original Code and Modifications, in each case including portions thereof.

1.4. "Electronic Distribution Mechanism" means a mechanism generally accepted in the software development community for the electronic transfer of data.

1.5. "Executable" means Covered Code in any form other than Source Code.

1.6. "Initial Developer" means the individual or entity identified as the Initial Developer in the Source Code notice required by Exhibit A.

1.7. "Larger Work" means a work which combines Covered Code or portions thereof with code not governed by the terms of this License.

1.8. "License" means this document.



1.8.1. "Licensable" means having the right to grant, to the maximum extent possible, whether at the time of the initial grant or subsequently acquired, any and all of the rights conveyed herein.

1.9. "Modifications" means any addition to or deletion from the substance or structure of either the Original Code or any previous Modifications. When Covered Code is released as a series of files, a Modification is:

A. Any addition to or deletion from the contents of a file containing Original Code or previous Modifications.

B. Any new file that contains any part of the Original Code or previous Modifications.

1.10. "Original Code" means Source Code of computer software code which is described in the Source Code notice required by Exhibit A as Original Code, and which, at the time of its release under this License is not already Covered Code governed by this License.

1.10.1. "Patent Claims" means any patent claim(s), now owned or hereafter acquired, including without limitation, method, process, and apparatus claims, in any patent Licensable by grantor.

1.11. "Source Code" means the preferred form of the Covered Code for making modifications to it, including all modules it contains, plus any associated interface definition files, scripts used to control compilation and installation of an Executable, or source code differential comparisons against either the Original Code or another well known, available Covered Code of the Contributor's choice. The Source Code can be in a compressed or archival form, provided the appropriate decompression or de-archiving software is widely available for no charge.

1.12. "You" (or "Your") means an individual or a legal entity exercising rights under, and complying with all of the terms of, this License or a future version of this License issued under Section 6.1. For legal entities, "You" includes any entity which controls, is controlled by, or is under common control with You. For purposes of this definition, "control" means (a) the power, direct or indirect, to cause the direction or management of such entity, whether by contract or otherwise, or (b) ownership of more than fifty percent (50%) of the outstanding shares or beneficial ownership of such entity.

2. Source Code License.

2.1. The Initial Developer Grant.

The Initial Developer hereby grants You a world-wide, royalty-free, non-exclusive license, subject to third party intellectual property claims:

(a) under intellectual property rights (other than patent or trademark) Licensable by Initial Developer to use, reproduce, modify, display, perform, sublicense and distribute the Original Code (or portions thereof) with or without Modifications, and/or as part of a Larger Work; and

(b) under Patents Claims infringed by the making, using or selling of Original Code, to make, have made, use, practice, sell, and offer for sale, and/or otherwise dispose of the Original Code (or portions thereof).

(c) the licenses granted in this Section 2.1(a) and (b) are effective on the date Initial Developer first distributes Original Code under the terms of this License.



(d) Notwithstanding Section 2.1(b) above, no patent license is granted: 1) for code that You delete from the Original Code; 2) separate from the Original Code; or 3) for infringements caused by: i) the modification of the Original Code or ii) the combination of the Original Code with other software or devices.

2.2. Contributor Grant.

Subject to third party intellectual property claims, each Contributor hereby grants You a world-wide, royalty-free, non-exclusive license

(a) under intellectual property rights (other than patent or trademark) Licensable by Contributor, to use, reproduce, modify, display, perform, sublicense and distribute the Modifications created by such Contributor (or portions thereof) either on an unmodified basis, with other Modifications, as Covered Code and/or as part of a Larger Work; and

(b) under Patent Claims infringed by the making, using, or selling of Modifications made by that Contributor either alone and/or in combination with its Contributor Version (or portions of such combination), to make, use, sell, offer for sale, have made, and/or otherwise dispose of: 1) Modifications made by that Contributor (or portions thereof); and 2) the combination of Modifications made by that Contributor with its Contributor Version (or portions of such combination).

(c) the licenses granted in Sections 2.2(a) and 2.2(b) are effective on the date Contributor first makes Commercial Use of the Covered Code.

(d) Notwithstanding Section 2.2(b) above, no patent license is granted: 1) for any code that Contributor has deleted from the Contributor Version; 2) separate from the Contributor Version; 3) for infringements caused by: i) third party modifications of Contributor Version or ii) the combination of Modifications made by that Contributor with other software (except as part of the Contributor Version) or other devices; or 4) under Patent Claims infringed by Covered Code in the absence of Modifications made by that Contributor.

3. Distribution Obligations.

3.1. Application of License.

The Modifications which You create or to which You contribute are governed by the terms of this License, including without limitation Section 2.2. The Source Code version of Covered Code may be distributed only under the terms of this License or a future version of this License released under Section 6.1, and You must include a copy of this License with every copy of the Source Code You distribute. You may not offer or impose any terms on any Source Code version that alters or restricts the applicable version of this License or the recipients' rights hereunder. However, You may include an additional document offering the additional rights described in Section 3.5.



3.2. Availability of Source Code.

Any Modification which You create or to which You contribute must be made available in Source Code form under the terms of this License either on the same media as an Executable version or via an accepted Electronic Distribution Mechanism to anyone to whom you made an Executable version available; and if made available via Electronic Distribution Mechanism, must remain available for at least twelve (12) months after the date it initially became available, or at least six (6) months after a subsequent version of that particular Modification has been made available to such recipients. You are responsible for ensuring that the Source Code version remains available even if the Electronic Distribution Mechanism is maintained by a third party.

3.3. Description of Modifications.

You must cause all Covered Code to which You contribute to contain a file documenting the changes You made to create that Covered Code and the date of any change. You must include a prominent statement that the Modification is derived, directly or indirectly, from Original Code provided by the Initial Developer and including the name of the Initial Developer in (a) the Source Code, and (b) in any notice in an Executable version or related documentation in which You describe the origin or ownership of the Covered Code.

3.4. Intellectual Property Matters

(a) Third Party Claims.

If Contributor has knowledge that a license under a third party's intellectual property rights is required to exercise the rights granted by such Contributor under Sections 2.1 or 2.2, Contributor must include a text file with the Source Code distribution titled "LEGAL" which describes the claim and the party making the claim in sufficient detail that a recipient will know whom to contact. If Contributor obtains such knowledge after the Modification is made available as described in Section 3.2, Contributor shall promptly modify the LEGAL file in all copies Contributor makes available thereafter and shall take other steps (such as notifying appropriate mailing lists or newsgroups) reasonably calculated to inform those who received the Covered Code that new knowledge has been obtained.

(b) Contributor APIs.

If Contributor's Modifications include an application programming interface and Contributor has knowledge of patent licenses which are reasonably necessary to implement that API, Contributor must also include this information in the LEGAL file.

(c) Representations.

Contributor represents that, except as disclosed pursuant to Section 3.4(a) above, Contributor believes that Contributor's Modifications are Contributor's original creation(s) and/or Contributor has sufficient rights to grant the rights conveyed by this License.



3.5. Required Notices.

You must duplicate the notice in Exhibit A in each file of the Source Code. If it is not possible to put such notice in a particular Source Code file due to its structure, then You must include such notice in a location (such as a relevant directory) where a user would be likely to look for such a notice. If You created one or more Modification(s) You may add your name as a Contributor to the notice described in Exhibit A. You must also duplicate this License in any documentation for the Source Code where You describe recipients' rights or ownership rights relating to Covered Code. You may choose to offer, and to charge a fee for, warranty, support, indemnity or liability obligations to one or more recipients of Covered Code. However, You may do so only on Your own behalf, and not on behalf of the Initial Developer or any Contributor. You must make it absolutely clear than any such warranty, support, indemnity or liability obligation is offered by You alone, and You hereby agree to indemnify the Initial Developer and every Contributor for any liability incurred by the Initial Developer or such Contributor as a result of warranty, support, indemnity or liability terms You offer.

3.6. Distribution of Executable Versions.

You may distribute Covered Code in Executable form only if the requirements of Section 3.1-3.5 have been met for that Covered Code, and if You include a notice stating that the Source Code version of the Covered Code is available under the terms of this License, including a description of how and where You have fulfilled the obligations of Section 3.2. The notice must be conspicuously included in any notice in an Executable version, related documentation or collateral in which You describe recipients' rights relating to the Covered Code. You may distribute the Executable version of Covered Code or ownership rights under a license of Your choice, which may contain terms different from this License, provided that You are in compliance with the terms of this License and that the license for the Executable version does not attempt to limit or alter the recipient's rights in the Source Code version from the rights set forth in this License. If You distribute the Executable version under a different license You must make it absolutely clear that any terms which differ from this License are offered by You alone, not by the Initial Developer or any Contributor. You hereby agree to indemnify the Initial Developer and every Contributor for any liability incurred by the Initial Developer or such Contributor as a result of any such terms You offer.

3.7. Larger Works.

You may create a Larger Work by combining Covered Code with other code not governed by the terms of this License and distribute the Larger Work as a single product. In such a case, You must make sure the requirements of this License are fulfilled for the Covered Code.



4. Inability to Comply Due to Statute or Regulation.

If it is impossible for You to comply with any of the terms of this License with respect to some or all of the Covered Code due to statute, judicial order, or regulation then You must: (a) comply with the terms of this License to the maximum extent possible; and (b) describe the limitations and the code they affect. Such description must be included in the LEGAL file described in Section 3.4 and must be included with all distributions of the Source Code. Except to the extent prohibited by statute or regulation, such description must be sufficiently detailed for a recipient of ordinary skill to be able to understand it.

5. Application of this License.

This License applies to code to which the Initial Developer has attached the notice in Exhibit A and to related Covered Code.

6. Versions of the License.

6.1. New Versions.

Netscape Communications Corporation ("Netscape") may publish revised and/or new versions of the License from time to time. Each version will be given a distinguishing version number.

6.2. Effect of New Versions.

Once Covered Code has been published under a particular version of the License, You may always continue to use it under the terms of that version. You may also choose to use such Covered Code under the terms of any subsequent version of the License published by Netscape. No one other than Netscape has the right to modify the terms applicable to Covered Code created under this License.

6.3. Derivative Works.

If You create or use a modified version of this License (which you may only do in order to apply it to code which is not already Covered Code governed by this License), You must (a) rename Your license so that the phrases "Mozilla", "MOZILLAPL", "MOZPL", "Netscape", "MPL", "NPL" or any confusingly similar phrase do not appear in your license (except to note that your license differs from this License) and (b) otherwise make it clear that Your version of the license contains terms which differ from the Mozilla Public License and Netscape Public License. (Filling in the name of the Initial Developer, Original Code or Contributor in the notice described in Exhibit A shall not of themselves be deemed to be modifications of this License.)

7. DISCLAIMER OF WARRANTY.

COVERED CODE IS PROVIDED UNDER THIS LICENSE ON AN "AS IS" BASIS, WITHOUT WARRANTY OF ANY KIND, EITHER EXPRESSED OR IMPLIED, INCLUDING, WITHOUT LIMITATION, WARRANTIES THAT THE COVERED CODE IS FREE OF DEFECTS, MERCHANTABILITY, FIT FOR A PARTICULAR PURPOSE OR NON-INFRINGEMENT. THE ENTIRE RISK AS TO THE QUALITY AND PERFORMANCE OF THE COVERED CODE IS WITH YOU. SHOULD ANY COVERED CODE PROVE DEFECTIVE IN ANY RESPECT, YOU (NOT THE INITIAL DEVELOPER OR ANY OTHER CONTRIBUTOR) ASSUME THE COST OF ANY NECESSARY SERVICING, REPAIR OR CORRECTION. THIS DISCLAIMER OF WARRANTY CONSTITUTES AN ESSENTIAL PART OF THIS LICENSE. NO USE OF ANY COVERED CODE IS AUTHORIZED HEREUNDER EXCEPT UNDER THIS DISCLAIMER.



8. TERMINATION.

8.1. This License and the rights granted hereunder will terminate automatically if You fail to comply with terms herein and fail to cure such breach within 30 days of becoming aware of the breach. All sublicenses to the Covered Code which are properly granted shall survive any termination of this License. Provisions which, by their nature, must remain in effect beyond the termination of this License shall survive.

8.2. If You initiate litigation by asserting a patent infringement claim (excluding declaratory judgment actions) against Initial Developer or a Contributor (the Initial Developer or Contributor against whom You file such action is referred to as "Participant") alleging that:

(a) such Participant's Contributor Version directly or indirectly infringes any patent, then any and all rights granted by such Participant to You under Sections 2.1 and/or 2.2 of this License shall, upon 60 days notice from Participant terminate prospectively, unless if within 60 days after receipt of notice You either: (i) agree in writing to pay Participant a mutually agreeable reasonable royalty for Your past and future use of Modifications made by such Participant, or (ii) withdraw Your litigation claim with respect to the Contributor Version against such Participant. If within 60 days of notice, a reasonable royalty and payment arrangement are not mutually agreed upon in writing by the parties or the litigation claim is not withdrawn, the rights granted by Participant to You under Sections 2.1 and/or 2.2 automatically terminate at the expiration of the 60 day notice period specified above.

(b) any software, hardware, or device, other than such Participant's Contributor Version, directly or indirectly infringes any patent, then any rights granted to You by such Participant under Sections 2.1(b) and 2.2(b) are revoked effective as of the date You first made, used, sold, distributed, or had made, Modifications made by that Participant.

8.3. If You assert a patent infringement claim against Participant alleging that such Participant's Contributor Version directly or indirectly infringes any patent where such claim is resolved (such as by license or settlement) prior to the initiation of patent infringement litigation, then the reasonable value of the licenses granted by such Participant under Sections 2.1 or 2.2 shall be taken into account in determining the amount or value of any payment or license.

8.4. In the event of termination under Sections 8.1 or 8.2 above, all end user license agreements (excluding distributors and resellers) which have been validly granted by You or any distributor hereunder prior to termination shall survive termination.



9. LIMITATION OF LIABILITY.

UNDER NO CIRCUMSTANCES AND UNDER NO LEGAL THEORY, WHETHER TORT (INCLUDING NEGLIGENCE), CONTRACT, OR OTHERWISE, SHALL YOU, THE INITIAL DEVELOPER, ANY OTHER CONTRIBUTOR, OR ANY DISTRIBUTOR OF COVERED CODE, OR ANY SUPPLIER OF ANY OF SUCH PARTIES, BE LIABLE TO ANY PERSON FOR ANY INDIRECT, SPECIAL, INCIDENTAL, OR CONSEQUENTIAL DAMAGES OF ANY CHARACTER INCLUDING, WITHOUT LIMITATION, DAMAGES FOR LOSS OF GOODWILL, WORK STOPPAGE, COMPUTER FAILURE OR MALFUNCTION, OR ANY AND ALL OTHER COMMERCIAL DAMAGES OR LOSSES, EVEN IF SUCH PARTY SHALL HAVE BEEN INFORMED OF THE POSSIBILITY OF SUCH DAMAGES. THIS LIMITATION OF LIABILITY SHALL NOT APPLY TO LIABILITY FOR DEATH OR PERSONAL INJURY RESULTING FROM SUCH PARTY'S NEGLIGENCE TO THE EXTENT APPLICABLE LAW PROHIBITS SUCH LIMITATION. SOME JURISDICTIONS DO NOT ALLOW THE EXCLUSION OR LIMITATION OF INCIDENTAL OR CONSEQUENTIAL DAMAGES, SO THIS EXCLUSION AND LIMITATION MAY NOT APPLY TO YOU.

10. U.S. GOVERNMENT END USERS.

The Covered Code is a "commercial item," as that term is defined in 48 C.F.R. 2.101 (Oct. 1995), consisting of "commercial computer software" and "commercial computer software documentation," as such terms are used in 48 C.F.R. 12.212 (Sept. 1995). Consistent with 48 C.F.R. 12.212 and 48 C.F.R. 227.7202-1 through 227.7202-4 (June 1995), all U.S. Government End Users acquire Covered Code with only those rights set forth herein.

11. MISCELLANEOUS.

This License represents the complete agreement concerning subject matter hereof. If any provision of this License is held to be unenforceable, such provision shall be reformed only to the extent necessary to make it enforceable. This License shall be governed by California law provisions (except to the extent applicable law, if any, provides otherwise), excluding its conflict-of-law provisions. With respect to disputes in which at least one party is a citizen of, or an entity chartered or registered to do business in the United States of America, any litigation relating to this License shall be subject to the jurisdiction of the Federal Courts of the Northern District of California, with venue lying in Santa Clara County, California, with the losing party responsible for costs, including without limitation, court costs and reasonable attorneys' fees and expenses. The application of the United Nations Convention on Contracts for the International Sale of Goods is expressly excluded. Any law or regulation which provides that the language of a contract shall be construed against the drafter shall not apply to this License.

12. RESPONSIBILITY FOR CLAIMS.

As between Initial Developer and the Contributors, each party is responsible for claims and damages arising, directly or indirectly, out of its utilization of rights under this License and You agree to work with Initial Developer and Contributors to distribute such responsibility on an equitable basis. Nothing herein is intended or shall be deemed to constitute any admission of liability.

13. MULTIPLE-LICENSED CODE.

Initial Developer may designate portions of the Covered Code as "Multiple-Licensed". "Multiple-Licensed" means that the Initial Developer permits you to utilize portions of the Covered Code under Your choice of the NPL or the alternative licenses, if any, specified by the Initial Developer in the file described in Exhibit A.



EXHIBIT A -Mozilla Public License.

"The contents of this file are subject to the Mozilla Public License Version 1.1 (the "License"); you may not use this file except in compliance with the License. You may obtain a copy of the License at <http://www.mozilla.org/MPL/>

Software distributed under the License is distributed on an "AS IS" basis, WITHOUT WARRANTY OF ANY KIND, either express or implied. See the License for the specific language governing rights and limitations under the License.

The Original Code is _____.

The Initial Developer of the Original Code is _____.

Portions created by _____ are Copyright (C) _____ . All Rights Reserved.

Contributor(s): _____.

Alternatively, the contents of this file may be used under the terms of the _____ license (the "[_____] License"), in which case the provisions of [_____] License are applicable instead of those above. If you wish to allow use of your version of this file only under the terms of the [_____] License and not to allow others to use your version of this file under the MPL, indicate your decision by deleting the provisions above and replace them with the notice and other provisions required by the [_____] License. If you do not delete the provisions above, a recipient may use your version of this file under either the MPL or the [_____] License."

[NOTE: The text of this Exhibit A may differ slightly from the text of the notices in the Source Code files of the Original Code. You should use the text of this Exhibit A rather than the text found in the Original Code Source Code for Your Modifications.]

❏ Jansson-2.1

Copyright (c) 2009-2016 Petri Lehtinen <petri@digip.org>

Permission is hereby granted, free of charge, to any person obtaining a copy of this software and associated documentation files (the "Software"), to deal in the Software without restriction, including without limitation the rights to use, copy, modify, merge, publish, distribute, sublicense, and/or sell copies of the Software, and to permit persons to whom the Software is furnished to do so, subject to the following conditions:

The above copyright notice and this permission notice shall be included in all copies or substantial portions of the Software.

THE SOFTWARE IS PROVIDED "AS IS", WITHOUT WARRANTY OF ANY KIND, EXPRESS OR IMPLIED, INCLUDING BUT NOT LIMITED TO THE WARRANTIES OF MERCHANTABILITY, FITNESS FOR A PARTICULAR PURPOSE AND NONINFRINGEMENT. IN NO EVENT SHALL THE AUTHORS OR COPYRIGHT HOLDERS BE LIABLE FOR ANY CLAIM, DAMAGES OR OTHER LIABILITY, WHETHER IN AN ACTION OF CONTRACT, TORT OR OTHERWISE, ARISING FROM, OUT OF OR IN CONNECTION WITH THE SOFTWARE OR THE USE OR OTHER DEALINGS IN THE SOFTWARE.



❑ libffi-3.2.1

libffi - Copyright (c) 1996-2014 Anthony Green, Red Hat, Inc and others.

See source files for details.

Permission is hereby granted, free of charge, to any person obtaining a copy of this software and associated documentation files (the "Software"), to deal in the Software without restriction, including without limitation the rights to use, copy, modify, merge, publish, distribute, sublicense, and/or sell copies of the Software, and to permit persons to whom the Software is furnished to do so, subject to the following conditions:

The above copyright notice and this permission notice shall be included in all copies or substantial portions of the Software.

THE SOFTWARE IS PROVIDED "AS IS", WITHOUT WARRANTY OF ANY KIND, EXPRESS OR IMPLIED, INCLUDING BUT NOT LIMITED TO THE WARRANTIES OF MERCHANTABILITY, FITNESS FOR A PARTICULAR PURPOSE AND NONINFRINGEMENT. IN NO EVENT SHALL THE AUTHORS OR COPYRIGHT HOLDERS BE LIABLE FOR ANY CLAIM, DAMAGES OR OTHER LIABILITY, WHETHER IN AN ACTION OF CONTRACT, TORT OR OTHERWISE, ARISING FROM, OUT OF OR IN CONNECTION WITH THE SOFTWARE OR THE USE OR OTHER DEALINGS IN THE SOFTWARE.

❑ libunwind-1.2.1

Copyright (c) 2002 Hewlett-Packard Co.

Permission is hereby granted, free of charge, to any person obtaining a copy of this software and associated documentation files (the Software), to deal in the Software without restriction, including without limitation the rights to use, copy, modify, merge, publish, distribute, sublicense, and/or sell copies of the Software, and to permit persons to whom the Software is furnished to do so, subject to the following conditions:

The above copyright notice and this permission notice shall be included in all copies or substantial portions of the Software.

THE SOFTWARE IS PROVIDED "AS IS", WITHOUT WARRANTY OF ANY KIND, EXPRESS OR IMPLIED, INCLUDING BUT NOT LIMITED TO THE WARRANTIES OF MERCHANTABILITY, FITNESS FOR A PARTICULAR PURPOSE AND NONINFRINGEMENT. IN NO EVENT SHALL THE AUTHORS OR COPYRIGHT HOLDERS BE LIABLE FOR ANY CLAIM, DAMAGES OR OTHER LIABILITY, WHETHER IN AN ACTION OF CONTRACT, TORT OR OTHERWISE, ARISING FROM, OUT OF OR IN CONNECTION WITH THE SOFTWARE OR THE USE OR OTHER DEALINGS IN THE SOFTWARE. SOFTWARE OR THE USE OR OTHER DEALINGS IN THE SOFTWARE.



❑ Dropbear-2018.76

The majority of code is written by Matt Johnston, under the license below.

Portions of the client-mode work are (c) 2004 Mihnea Stoenescu, under the same license:

Copyright (c) 2002-2015 Matt Johnston

Portions copyright (c) 2004 Mihnea Stoenescu

All rights reserved.

Permission is hereby granted, free of charge, to any person obtaining a copy of this software and associated documentation files (the "Software"), to deal in the Software without restriction, including without limitation the rights to use, copy, modify, merge, publish, distribute, sublicense, and/or sell copies of the Software, and to permit persons to whom the Software is furnished to do so, subject to the following conditions:

The above copyright notice and this permission notice shall be included in all copies or substantial portions of the Software.

THE SOFTWARE IS PROVIDED "AS IS", WITHOUT WARRANTY OF ANY KIND, EXPRESS OR IMPLIED, INCLUDING BUT NOT LIMITED TO THE WARRANTIES OF MERCHANTABILITY, FITNESS FOR A PARTICULAR PURPOSE AND NONINFRINGEMENT. IN NO EVENT SHALL THE AUTHORS OR COPYRIGHT HOLDERS BE LIABLE FOR ANY CLAIM, DAMAGES OR OTHER LIABILITY, WHETHER IN AN ACTION OF CONTRACT, TORT OR OTHERWISE, ARISING FROM, OUT OF OR IN CONNECTION WITH THE SOFTWARE OR THE USE OR OTHER DEALINGS IN THE SOFTWARE.

=====

LibTomCrypt and LibTomMath are written by Tom St Denis, and are Public Domain.

=====

sshpty.c is taken from OpenSSH 3.5p1,

Copyright (c) 1995 Tatu Ylonen <ylo@cs.hut.fi>, Espoo, Finland

All rights reserved

"As far as I am concerned, the code I have written for this software can be used freely for any purpose. Any derived versions of this software must be clearly marked as such, and if the derived work is incompatible with the protocol description in the RFC file, it must be called by a name other than "ssh" or "Secure Shell". "

=====

loginrec.c

loginrec.h

atomicio.h

atomicio.c

and strlcat() (included in util.c) are from OpenSSH 3.6.1p2, and are licensed under the 2 point BSD license.

loginrec is written primarily by Andre Lucas, atomicio.c by Theo de Raadt.

strlcat() is (c) Todd C. Miller

=====

Import code in keyimport.c is modified from PuTTY's import.c, licensed as follows:

PuTTY is copyright 1997-2003 Simon Tatham.

Portions copyright Robert de Bath, Joris van Rantwijk, Delian Delchev, Andreas Schultz, Jeroen Massar, Wez Furlong, Nicolas Barry, Justin Bradford, and CORE SDI S.A.



Permission is hereby granted, free of charge, to any person obtaining a copy of this software and associated documentation files (the "Software"), to deal in the Software without restriction, including without limitation the rights to use, copy, modify, merge, publish, distribute, sublicense, and/or sell copies of the Software, and to permit persons to whom the Software is furnished to do so, subject to the following conditions:

The above copyright notice and this permission notice shall be included in all copies or substantial portions of the Software.

THE SOFTWARE IS PROVIDED "AS IS", WITHOUT WARRANTY OF ANY KIND, EXPRESS OR IMPLIED, INCLUDING BUT NOT LIMITED TO THE WARRANTIES OF MERCHANTABILITY, FITNESS FOR A PARTICULAR PURPOSE AND NONINFRINGEMENT. IN NO EVENT SHALL THE COPYRIGHT HOLDERS BE LIABLE FOR ANY CLAIM, DAMAGES OR OTHER LIABILITY, WHETHER IN AN ACTION OF CONTRACT, TORT OR OTHERWISE, ARISING FROM, OUT OF OR IN CONNECTION WITH THE SOFTWARE OR THE USE OR OTHER DEALINGS IN THE SOFTWARE.

=====

curve25519-donna:

Copyright 2008, Google Inc.

All rights reserved.

Redistribution and use in source and binary forms, with or without modification, are permitted provided that the following conditions are met:

* Redistributions of source code must retain the above copyright notice, this list of conditions and the following disclaimer.

* Redistributions in binary form must reproduce the above copyright notice, this list of conditions and the following disclaimer in the documentation and/or other materials provided with the distribution.

* Neither the name of Google Inc. nor the names of its contributors may be used to endorse or promote products derived from this software without specific prior written permission.

THIS SOFTWARE IS PROVIDED BY THE COPYRIGHT HOLDERS AND CONTRIBUTORS "AS IS" AND ANY EXPRESS OR IMPLIED WARRANTIES, INCLUDING, BUT NOT LIMITED TO, THE IMPLIED WARRANTIES OF MERCHANTABILITY AND FITNESS FOR A PARTICULAR PURPOSE ARE DISCLAIMED. IN NO EVENT SHALL THE COPYRIGHT OWNER OR CONTRIBUTORS BE LIABLE FOR ANY DIRECT, INDIRECT, INCIDENTAL, SPECIAL, EXEMPLARY, OR CONSEQUENTIAL DAMAGES (INCLUDING, BUT NOT LIMITED TO, PROCUREMENT OF SUBSTITUTE GOODS OR SERVICES; LOSS OF USE, DATA, OR PROFITS; OR BUSINESS INTERRUPTION) HOWEVER CAUSED AND ON ANY THEORY OF LIABILITY, WHETHER IN CONTRACT, STRICT LIABILITY, OR TORT (INCLUDING NEGLIGENCE OR OTHERWISE) ARISING IN ANY WAY OUT OF THE USE OF THIS SOFTWARE, EVEN IF ADVISED OF THE POSSIBILITY OF SUCH DAMAGE.

curve25519-donna: Curve25519 elliptic curve, public key function

<http://code.google.com/p/curve25519-donna/>

Adam Langley <agl@imperialviolet.org>

Derived from public domain C code by Daniel J. Bernstein <djb@cr.yp.to>

More information about curve25519 can be found here

<http://cr.yp.to/ecdh.html>

djb's sample implementation of curve25519 is written in a special assembly language called qhasm and uses the floating point registers.

This is, almost, a clean room reimplementation from the curve25519 paper. It uses many of the tricks described therein. Only the crecip function is taken from the sample implementation.



❑ OpenSSL-1.0.2p

The OpenSSL toolkit stays under a double license, i.e. both the conditions of the OpenSSL License and the original SSLeay license apply to the toolkit. See below for the actual license texts. Actually both licenses are BSD-style Open Source licenses. In case of any license issues related to OpenSSL please contact openssl-core@openssl.org.

OpenSSL License

Copyright (c) 1998-2018 The OpenSSL Project. All rights reserved.

Redistribution and use in source and binary forms, with or without modification, are permitted provided that the following conditions are met:

1. Redistributions of source code must retain the above copyright notice, this list of conditions and the following disclaimer.
2. Redistributions in binary form must reproduce the above copyright notice, this list of conditions and the following disclaimer in the documentation and/or other materials provided with the distribution.
3. All advertising materials mentioning features or use of this software must display the following acknowledgment: "This product includes software developed by the OpenSSL Project for use in the OpenSSL Toolkit. (<http://www.openssl.org/>)"
4. The names "OpenSSL Toolkit" and "OpenSSL Project" must not be used to endorse or promote products derived from this software without prior written permission. For written permission, please contact openssl-core@openssl.org.
5. Products derived from this software may not be called "OpenSSL" nor may "OpenSSL" appear in their names without prior written permission of the OpenSSL Project.

6. Redistributions of any form whatsoever must retain the following acknowledgment: "This product includes software developed by the OpenSSL Project for use in the OpenSSL Toolkit (<http://www.openssl.org/>)"

THIS SOFTWARE IS PROVIDED BY THE OPENSSL PROJECT "AS IS" AND ANY EXPRESSED OR IMPLIED WARRANTIES, INCLUDING, BUT NOT LIMITED TO, THE IMPLIED WARRANTIES OF MERCHANTABILITY AND FITNESS FOR A PARTICULAR PURPOSE ARE DISCLAIMED. IN NO EVENT SHALL THE OPENSSL PROJECT OR ITS CONTRIBUTORS BE LIABLE FOR ANY DIRECT, INDIRECT, INCIDENTAL, SPECIAL, EXEMPLARY, OR CONSEQUENTIAL DAMAGES (INCLUDING, BUT NOT LIMITED TO, PROCUREMENT OF SUBSTITUTE GOODS OR SERVICES; LOSS OF USE, DATA, OR PROFITS; OR BUSINESS INTERRUPTION) HOWEVER CAUSED AND ON ANY THEORY OF LIABILITY, WHETHER IN CONTRACT, STRICT LIABILITY, OR TORT (INCLUDING NEGLIGENCE OR OTHERWISE) ARISING IN ANY WAY OUT OF THE USE OF THIS SOFTWARE, EVEN IF ADVISED OF THE POSSIBILITY OF SUCH DAMAGE.

This product includes cryptographic software written by Eric Young (eay@cryptsoft.com). This product includes software written by Tim Hudson (tjh@cryptsoft.com).

Original SSLeay License

Copyright (C) 1995-1998 Eric Young (eay@cryptsoft.com)

All rights reserved.

This package is an SSL implementation written by Eric Young (eay@cryptsoft.com).

The implementation was written so as to conform with Netscapes SSL.



This library is free for commercial and non-commercial use as long as the following conditions are adhered to. The following conditions apply to all code found in this distribution, be it the RC4, RSA, lhash, DES, etc., code; not just the SSL code. The SSL documentation included with this distribution is covered by the same copyright terms except that the holder is Tim Hudson (tjh@cryptsoft.com).

Copyright remains Eric Young's, and as such any Copyright notices in the code are not to be removed. If this package is used in a product, Eric Young should be given attribution as the author of the parts of the library used. This can be in the form of a textual message at program startup or in documentation (online or textual) provided with the package.

Redistribution and use in source and binary forms, with or without modification, are permitted provided that the following conditions are met:

1. Redistributions of source code must retain the copyright notice, this list of conditions and the following disclaimer.
2. Redistributions in binary form must reproduce the above copyright notice, this list of conditions and the following disclaimer in the documentation and/or other materials provided with the distribution.
3. All advertising materials mentioning features or use of this software must display the following acknowledgement: "This product includes cryptographic software written by Eric Young (eay@cryptsoft.com)" The word 'cryptographic' can be left out if the routines from the library being used are not cryptographic related :-).
4. If you include any Windows specific code (or a derivative thereof) from the apps directory (application code) you must include an acknowledgement: "This product includes software written by Tim Hudson (tjh@cryptsoft.com)"

THIS SOFTWARE IS PROVIDED BY ERIC YOUNG "AS IS" AND ANY EXPRESS OR IMPLIED WARRANTIES, INCLUDING, BUT NOT LIMITED TO, THE IMPLIED WARRANTIES OF MERCHANTABILITY AND FITNESS FOR A PARTICULAR PURPOSE ARE DISCLAIMED. IN NO EVENT SHALL THE AUTHOR OR CONTRIBUTORS BE LIABLE FOR ANY DIRECT, INDIRECT, INCIDENTAL, SPECIAL, EXEMPLARY, OR CONSEQUENTIAL DAMAGES (INCLUDING, BUT NOT LIMITED TO, PROCUREMENT OF SUBSTITUTE GOODS OR SERVICES; LOSS OF USE, DATA, OR PROFITS; OR BUSINESS INTERRUPTION) HOWEVER CAUSED AND ON ANY THEORY OF LIABILITY, WHETHER IN CONTRACT, STRICT LIABILITY, OR TORT (INCLUDING NEGLIGENCE OR OTHERWISE) ARISING IN ANY WAY OUT OF THE USE OF THIS SOFTWARE, EVEN IF ADVISED OF THE POSSIBILITY OF SUCH DAMAGE.

The licence and distribution terms for any publically available version or derivative of this code cannot be changed. i.e. this code cannot simply be copied and put under another distribution licence [including the GNU Public Licence.]



❑ SQLite-3.21.0

SQLite Is Public Domain

SQLite is in the Public Domain

All of the code and documentation in SQLite has been dedicated to the public domain by the authors. All code authors, and representatives of the companies they work for, have signed affidavits dedicating their contributions to the public domain and originals of those signed affidavits are stored in a firesafe at the main offices of Hwaci. Anyone is free to copy, modify, publish, use, compile, sell, or distribute the original SQLite code, either in source code form or as a compiled binary, for any purpose, commercial or non-commercial, and by any means.

The previous paragraph applies to the deliverable code and documentation in SQLite - those parts of the SQLite library that you actually bundle and ship with a larger application. Some scripts used as part of the build process (for example the "configure" scripts generated by autoconf) might fall under other open-source licenses. Nothing from these build scripts ever reaches the final deliverable SQLite library, however, and so the licenses associated with those scripts should not be a factor in assessing your rights to copy and use the SQLite library.

All of the deliverable code in SQLite has been written from scratch. No code has been taken from other projects or from the open internet. Every line of code can be traced back to its original author, and all of those authors have public domain dedications on file. So the SQLite code base is clean and is uncontaminated with licensed code from other projects.

❑ zlib-1.2.11

Copyright notice:

(C) 1995-2017 Jean-loup Gailly and Mark Adler

This software is provided 'as-is', without any express or implied warranty. In no event will the authors be held liable for any damages arising from the use of this software.

Permission is granted to anyone to use this software for any purpose, including commercial applications, and to alter it and redistribute it freely, subject to the following restrictions:

1. The origin of this software must not be misrepresented; you must not claim that you wrote the original software. If you use this software in a product, an acknowledgment in the product documentation would be appreciated but is not required.
2. Altered source versions must be plainly marked as such, and must not be misrepresented as being the original software.
3. This notice may not be removed or altered from any source distribution.

Jean-loup Gailly Mark Adler

jloup@gzip.org madler@alumni.caltech.edu

If you use the zlib library in a product, we would appreciate *not* receiving lengthy legal documents to sign. The sources are provided for free but without warranty of any kind. The library has been entirely written by Jean-loup Gailly and Mark Adler; it does not include third-party code.

If you redistribute modified sources, we would appreciate that you include in the file ChangeLog history information documenting your changes. Please read the FAQ for more information on the distribution of modified source versions.



❑ e2fsprogs-libs-1.45.4/lib/uuid

Redistribution and use in source and binary forms, with or without modification, are permitted provided that the following conditions are met:

1. Redistributions of source code must retain the above copyright notice, this list of conditions and the following disclaimer.
2. Redistributions in binary form must reproduce the above copyright notice, this list of conditions and the following disclaimer in the documentation and/or other materials provided with the distribution.

THIS SOFTWARE IS PROVIDED BY THE COPYRIGHT HOLDERS AND CONTRIBUTORS "AS IS" AND ANY EXPRESS OR IMPLIED WARRANTIES, INCLUDING, BUT NOT LIMITED TO, THE IMPLIED WARRANTIES OF MERCHANTABILITY AND FITNESS FOR A PARTICULAR PURPOSE ARE DISCLAIMED. IN NO EVENT SHALL THE COPYRIGHT HOLDER OR CONTRIBUTORS BE LIABLE FOR ANY DIRECT, INDIRECT, INCIDENTAL, SPECIAL, EXEMPLARY, OR CONSEQUENTIAL DAMAGES (INCLUDING, BUT NOT LIMITED TO, PROCUREMENT OF SUBSTITUTE GOODS OR SERVICES; LOSS OF USE, DATA, OR PROFITS; OR BUSINESS INTERRUPTION) HOWEVER CAUSED AND ON ANY THEORY OF LIABILITY, WHETHER IN CONTRACT, STRICT LIABILITY, OR TORT (INCLUDING NEGLIGENCE OR OTHERWISE) ARISING IN ANY WAY OUT OF THE USE OF THIS SOFTWARE, EVEN IF ADVISED OF THE POSSIBILITY OF SUCH DAMAGE.

❑ Expat-2.2.5

Copyright (c) 1998-2000 Thai Open Source Software Center Ltd and Clark Cooper

Copyright (c) 2001-2017 Expat maintainers

Permission is hereby granted, free of charge, to any person obtaining a copy of this software and associated documentation files (the Software), to deal in the Software without restriction, including without limitation the rights to use, copy, modify, merge, publish, distribute, sublicense, and/or sell copies of the Software, and to permit persons to whom the Software is furnished to do so, subject to the following conditions:

The above copyright notice and this permission notice shall be included in all copies or substantial portions of the Software.

THE SOFTWARE IS PROVIDED "AS IS", WITHOUT WARRANTY OF ANY KIND, EXPRESS OR IMPLIED, INCLUDING BUT NOT LIMITED TO THE WARRANTIES OF MERCHANTABILITY, FITNESS FOR A PARTICULAR PURPOSE AND NONINFRINGEMENT. IN NO EVENT SHALL THE AUTHORS OR COPYRIGHT HOLDERS BE LIABLE FOR ANY CLAIM, DAMAGES OR OTHER LIABILITY, WHETHER IN AN ACTION OF CONTRACT, TORT OR OTHERWISE, ARISING FROM, OUT OF OR IN CONNECTION WITH THE SOFTWARE OR THE USE OR OTHER DEALINGS IN THE SOFTWARE.



❑ getopt-1.29

Copyright (c) 1987, 1993, 1994

The Regents of the University of California. All rights reserved.

Redistribution and use in source and binary forms, with or without modification, are permitted provided that the following conditions are met:

1. Redistributions of source code must retain the above copyright notice, this list of conditions and the following disclaimer.
2. Redistributions in binary form must reproduce the above copyright notice, this list of conditions and the following disclaimer in the documentation and/or other materials provided with the distribution.
3. Neither the name of the University nor the names of its contributors may be used to endorse or promote products derived from this software without specific prior written permission.

THIS SOFTWARE IS PROVIDED BY THE REGENTS AND CONTRIBUTORS "AS IS" AND ANY EXPRESS OR IMPLIED WARRANTIES, INCLUDING, BUT NOT LIMITED TO, THE IMPLIED WARRANTIES OF MERCHANTABILITY AND FITNESS FOR A PARTICULAR PURPOSE ARE DISCLAIMED. IN NO EVENT SHALL THE REGENTS OR CONTRIBUTORS BE LIABLE FOR ANY DIRECT, INDIRECT, INCIDENTAL, SPECIAL, EXEMPLARY, OR CONSEQUENTIAL DAMAGES (INCLUDING, BUT NOT LIMITED TO, PROCUREMENT OF SUBSTITUTE GOODS OR SERVICES; LOSS OF USE, DATA, OR PROFITS; OR BUSINESS INTERRUPTION) HOWEVER CAUSED AND ON ANY THEORY OF LIABILITY, WHETHER IN CONTRACT, STRICT LIABILITY, OR TORT (INCLUDING NEGLIGENCE OR OTHERWISE) ARISING IN ANY WAY OUT OF THE USE OF THIS SOFTWARE, EVEN IF ADVISED OF THE POSSIBILITY OF SUCH DAMAGE.

❑ jQuery-1.6.1

Copyright 2014 jQuery Foundation and other contributors

<http://jquery.com/>

Permission is hereby granted, free of charge, to any person obtaining a copy of this software and associated documentation files (the Software), to deal in the Software without restriction, including without limitation the rights to use, copy, modify, merge, publish, distribute, sublicense, and/or sell copies of the Software, and to permit persons to whom the Software is furnished to do so, subject to the following conditions:

The above copyright notice and this permission notice shall be included in all copies or substantial portions of the Software.

THE SOFTWARE IS PROVIDED "AS IS", WITHOUT WARRANTY OF ANY KIND, EXPRESS OR IMPLIED, INCLUDING BUT NOT LIMITED TO THE WARRANTIES OF MERCHANTABILITY, FITNESS FOR A PARTICULAR PURPOSE AND NONINFRINGEMENT. IN NO EVENT SHALL THE AUTHORS OR COPYRIGHT HOLDERS BE LIABLE FOR ANY CLAIM, DAMAGES OR OTHER LIABILITY, WHETHER IN AN ACTION OF CONTRACT, TORT OR OTHERWISE, ARISING FROM, OUT OF OR IN CONNECTION WITH THE SOFTWARE OR THE USE OR OTHER DEALINGS IN THE SOFTWARE.



❑ LK embedded kernel

Copyright (c) 2008-2015 Travis Geiselbrecht

Permission is hereby granted, free of charge, to any person obtaining a copy of this software and associated documentation files (the "Software"), to deal in the Software without restriction, including without limitation the rights to use, copy, modify, merge, publish, distribute, sublicense, and/or sell copies of the Software, and to permit persons to whom the Software is furnished to do so, subject to the following conditions:

The above copyright notice and this permission notice shall be included in all copies or substantial portions of the Software.

THE SOFTWARE IS PROVIDED "AS IS", WITHOUT WARRANTY OF ANY KIND, EXPRESS OR IMPLIED, INCLUDING BUT NOT LIMITED TO THE WARRANTIES OF MERCHANTABILITY, FITNESS FOR A PARTICULAR PURPOSE AND NONINFRINGEMENT. IN NO EVENT SHALL THE AUTHORS OR COPYRIGHT HOLDERS BE LIABLE FOR ANY CLAIM, DAMAGES OR OTHER LIABILITY, WHETHER IN AN ACTION OF CONTRACT, TORT OR OTHERWISE, ARISING FROM, OUT OF OR IN CONNECTION WITH THE SOFTWARE OR THE USE OR OTHER DEALINGS IN THE SOFTWARE.

❑ mongoose-2.5

Copyright (c) 2004-2009 Sergey Lyubka

Permission is hereby granted, free of charge, to any person obtaining a copy of this software and associated documentation files (the "Software"), to deal in the Software without restriction, including without limitation the rights to use, copy, modify, merge, publish, distribute, sublicense, and/or sell copies of the Software, and to permit persons to whom the Software is furnished to do so, subject to the following conditions:

The above copyright notice and this permission notice shall be included in all copies or substantial portions of the Software.

THE SOFTWARE IS PROVIDED "AS IS", WITHOUT WARRANTY OF ANY KIND, EXPRESS OR IMPLIED, INCLUDING BUT NOT LIMITED TO THE WARRANTIES OF MERCHANTABILITY, FITNESS FOR A PARTICULAR PURPOSE AND NONINFRINGEMENT. IN NO EVENT SHALL THE AUTHORS OR COPYRIGHT HOLDERS BE LIABLE FOR ANY CLAIM, DAMAGES OR OTHER LIABILITY, WHETHER IN AN ACTION OF CONTRACT, TORT OR OTHERWISE, ARISING FROM, OUT OF OR IN CONNECTION WITH THE SOFTWARE OR THE USE OR OTHER DEALINGS IN THE SOFTWARE.



❑ portmap-6.0

Copyright (c) 1990 The Regents of the University of California.
All rights reserved.

Redistribution and use in source and binary forms, with or without modification, are permitted provided that the following conditions are met:

1. Redistributions of source code must retain the above copyright notice, this list of conditions and the following disclaimer.
2. Redistributions in binary form must reproduce the above copyright notice, this list of conditions and the following disclaimer in the documentation and/or other materials provided with the distribution.
3. All advertising materials mentioning features or use of this software must display the following acknowledgement: This product includes software developed by the University of California, Berkeley and its contributors.
4. Neither the name of the University nor the names of its contributors may be used to endorse or promote products derived from this software without specific prior written permission.

THIS SOFTWARE IS PROVIDED BY THE REGENTS AND CONTRIBUTORS "AS IS" AND ANY EXPRESS OR IMPLIED WARRANTIES, INCLUDING, BUT NOT LIMITED TO, THE IMPLIED WARRANTIES OF MERCHANTABILITY AND FITNESS FOR A PARTICULAR PURPOSE ARE DISCLAIMED. IN NO EVENT SHALL THE REGENTS OR CONTRIBUTORS BE LIABLE FOR ANY DIRECT, INDIRECT, INCIDENTAL, SPECIAL, EXEMPLARY, OR CONSEQUENTIAL DAMAGES (INCLUDING, BUT NOT LIMITED TO, PROCUREMENT OF SUBSTITUTE GOODS OR SERVICES; LOSS OF USE, DATA, OR PROFITS; OR BUSINESS INTERRUPTION) HOWEVER CAUSED AND ON ANY THEORY OF LIABILITY, WHETHER IN CONTRACT, STRICT LIABILITY, OR TORT (INCLUDING NEGLIGENCE OR OTHERWISE) ARISING IN ANY WAY OUT OF THE USE OF THIS SOFTWARE, EVEN IF ADVISED OF THE POSSIBILITY OF SUCH DAMAGE.

❑ strlcpy-1.5

Copyright (c) 1998 Todd C. Miller <Todd.Miller@courtesan.com>
All rights reserved.

Redistribution and use in source and binary forms, with or without modification, are permitted provided that the following conditions are met:

1. Redistributions of source code must retain the above copyright notice, this list of conditions and the following disclaimer.
2. Redistributions in binary form must reproduce the above copyright notice, this list of conditions and the following disclaimer in the documentation and/or other materials provided with the distribution.
3. The name of the author may not be used to endorse or promote products derived from this software without specific prior written permission.

THIS SOFTWARE IS PROVIDED "AS IS" AND ANY EXPRESS OR IMPLIED WARRANTIES, INCLUDING, BUT NOT LIMITED TO, THE IMPLIED WARRANTIES OF MERCHANTABILITY AND FITNESS FOR A PARTICULAR PURPOSE ARE DISCLAIMED. IN NO EVENT SHALL THE AUTHOR BE LIABLE FOR ANY DIRECT, INDIRECT, INCIDENTAL, SPECIAL, EXEMPLARY, OR CONSEQUENTIAL DAMAGES (INCLUDING, BUT NOT LIMITED TO, PROCUREMENT OF SUBSTITUTE GOODS OR SERVICES; LOSS OF USE, DATA, OR PROFITS; OR BUSINESS INTERRUPTION) HOWEVER CAUSED AND ON ANY THEORY OF LIABILITY, WHETHER IN CONTRACT, STRICT LIABILITY, OR TORT (INCLUDING NEGLIGENCE OR OTHERWISE) ARISING IN ANY WAY OUT OF THE USE OF THIS SOFTWARE, EVEN IF ADVISED OF THE POSSIBILITY OF SUCH DAMAGE.



❑ tinyxml-1.0.6

Original code (2.0 and earlier)copyright (c) 2000-2002 Lee Thomason (www.grinninglizard.com)

This software is provided 'as-is', without any express or implied warranty. In no event will the authors be held liable for any damages arising from the use of this software.

Permission is granted to anyone to use this software for any purpose, including commercial applications, and to alter it and redistribute it freely, subject to the following restrictions:

1. The origin of this software must not be misrepresented; you must not claim that you wrote the original software. If you use this software in a product, an acknowledgment in the product documentation would be appreciated but is not required.
2. Altered source versions must be plainly marked as such, and must not be misrepresented as being the original software.
3. This notice may not be removed or altered from any source distribution.

❑ El software Spotify está sujeto a las licencias de terceros que puede encontrar aquí:

www.spotify.com/connect/third-party-licenses



DENON®

www.denon.com

3520 10704 00AD

Copyright © 2019 D&M Holdings Inc. All Rights Reserved.