

DENON[®]

PMA-50

INTEGRATED AMPLIFIER

Owner's Manual

You can print more than one page of a PDF onto a single sheet of paper.

[Front panel](#)[Display](#)[Rear panel](#)[Remote](#)[Index](#)

Accessories	4
Features	5
High quality	5
High performance	5
Part names and functions	6
Front panel	6
Display	8
Rear panel	9
Remote control unit	10

Connections

Connections	11
Installing this unit	12
Installing horizontally	12
Installing vertically	13
Before using the remote control unit	15
Operating range of the remote control unit	16
Connecting speakers	17
Speaker connection	18
Connecting to a device with analog audio output connectors	19
Connecting to a device with digital audio output connectors	20
Connecting a PC or Mac	21
Connecting the power cord	22

Playback

Basic operation	24
Turning the power on	24
Selecting the input source	25
Adjusting the master volume	26
Switching the display's brightness	26
Playing a device	27
Playing music on a computer (USB-DAC)	27
Listening to music via a digital connection (COAXIAL/ OPTICAL-1/OPTICAL-2)	35
Listening to music via an analog connection (AUX)	36
Listening to music on a Bluetooth device	37

Setting procedure

Menu map	45
Source Direct	47
Bass	47
Treble	47
Balance	47
H/P AMP Gain	47
Bluetooth	48
Auto Standby	48



Tips

Tips	50
Troubleshooting	51
Resetting to factory settings	58

Appendix



Types of playable digital audio input signals	59
D/A Converter	59
Playing back Bluetooth devices	59
Bluetooth communications	59
Explanation of terms	60
Trademark information	61
Specifications	62
Index	65



Thank you for purchasing this Denon product. To ensure proper operation, please read this owner's manual carefully before using the product. After reading this manual, be sure to keep it for future reference.

Accessories

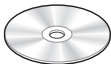
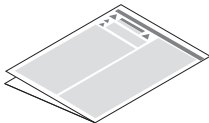
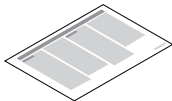
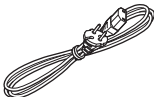
Check that the following parts are supplied with the product.

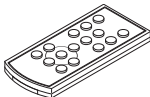
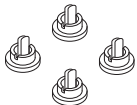
 Quick Start Guide	 Owner's Manual	 Safety Instructions	 Notes on radio
 Power cord	 USB cable	 Remote control unit (RC-1202) (built-in battery)	 Caps (silver) (x4)



Features

High quality

- **Equipped with a high-quality class D amplifier**

The amplifier section incorporates DDFA[®] technology from CSR. The output stage circuit has a discrete construction which realizes higher S/N and lower distortion compared to conventional class D amplifiers. Additionally, the high 50 W/4 Ω output which exceeds the size of the housing lets you enjoy Denon's ideal audio playback environment that delivers "delicate yet powerful sound".

- **Advanced AL32 Processing**

Equipped with Advanced AL32 Processing, Denon's unique analog wave reproduction technology. Reproducibility of weak signals is increased by expanding the 16-bit digital data to 32 bits.

High performance

- **Supports playback of high resolution audio files**

DSD signals and up to 192 kHz/24 bit PCM signals are supported. You can enjoy high-quality audio playback from this unit by inputting music files into this unit from a computer via USB connection.

- **Wireless connection with Bluetooth enabled devices (📖 p. 37)**

You can connect Bluetooth enabled devices such as smartphones and tablets with this unit to listen to music while browsing email and Web sites in the Internet away from this unit. In addition, this unit supports high quality audio codecs, aptX and AAC, to enjoy music and games with a powerful sound.

- **NFC function included that enables one touch connection (📖 p. 42)**

You can just touch this unit with an NFC enabled smartphone or tablet to turn on power to this unit and establish the Bluetooth connection.

- **Supports vertical installation**

This unit can be installed vertically or horizontally. The display automatically rotates to match the installation orientation.



Part names and functions

Front panel

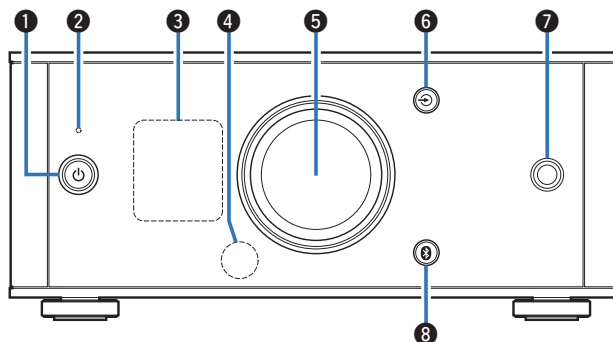

❶ Power operation button (⏻)

This turns the power on/to standby. (☞ p. 24)

The power status is indicated as follows.

- Power on: Display lit
- Standby: Display off

❷ Protection circuit indicator

This blinks when the protection circuit has operated. (☞ p. 52, 60)

❸ Display

This displays various pieces of information.

❹ Remote control sensor

This receives signals from the remote control unit. (☞ p. 16)

❺ Volume control knob

This adjusts the volume level. (☞ p. 26)

❻ Input source switching button (↺)

This switches input sources. (☞ p. 25)



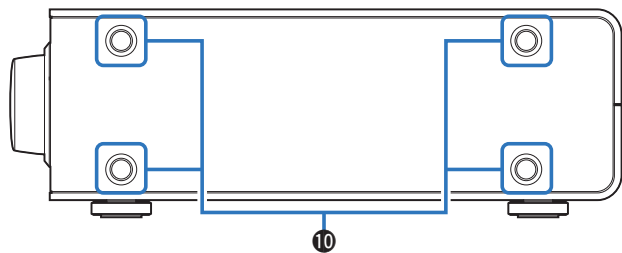
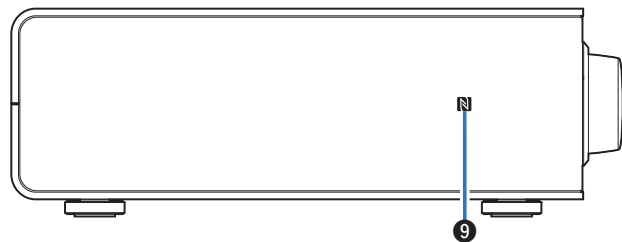
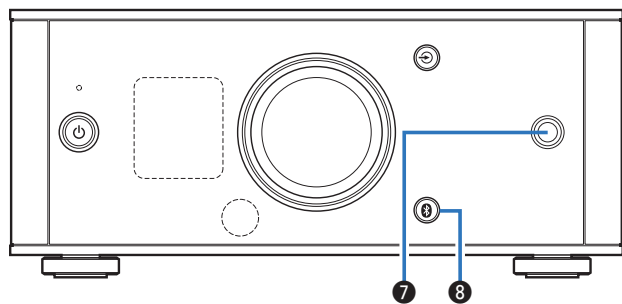

7 Headphones jack

Used to connect headphones.

When the headphones are plugged into this jack, audio will no longer be output from the speaker terminals.

NOTE

To prevent hearing loss, do not raise the volume level excessively when using headphones.

8 Bluetooth button (ⓑ)

This switches the input to Bluetooth. This is also pressed during the pairing operation. (☞ p. 38)

9 N mark (N)

Touch this mark with a Bluetooth device that includes the NFC function when pairing (registering) with it. (☞ p. 42)

10 Installation holes for vertical installation feet

These are used when the unit is installed vertically. (☞ p. 13)





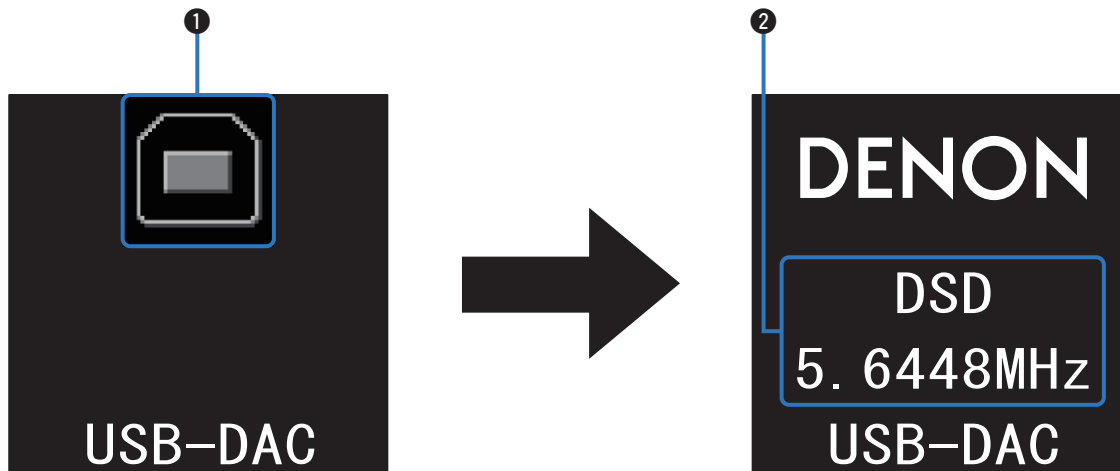



Display



1 Input source indicator

The following is displayed depending on the selected input source.

USB-DAC	COAXIAL	OPTICAL-1	OPTICAL-2	AUX	Bluetooth
					

2 Information display

Displays items such as information on the audio signal being input or the name of a Bluetooth device.

Rear panel

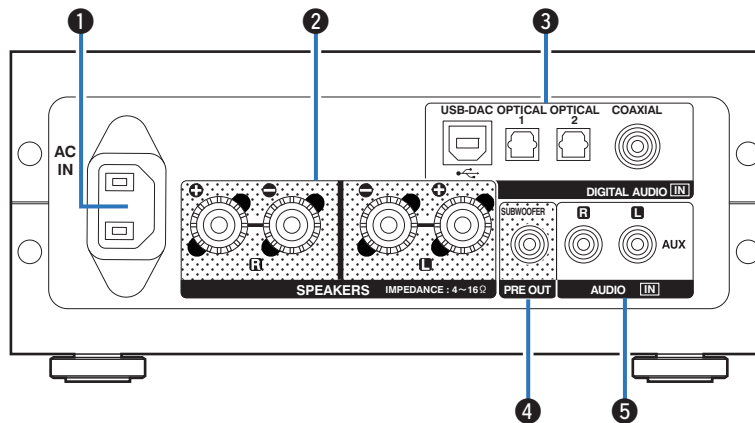

1 AC inlet (AC IN)

Used to connect the supplied power cord. (☞ p. 22)

2 Speaker terminals (SPEAKERS)

Used to connect speakers. (☞ p. 18)

3 DIGITAL AUDIO IN connectors

Used to connect devices equipped with PC and digital audio output connectors.

4 Subwoofer terminal (PRE OUT)

Used to connect a subwoofer with a built-in amplifier.

5 AUX input connectors (AUDIO IN)

Used to connect devices equipped with analog audio connectors such as CD players.



Remote control unit

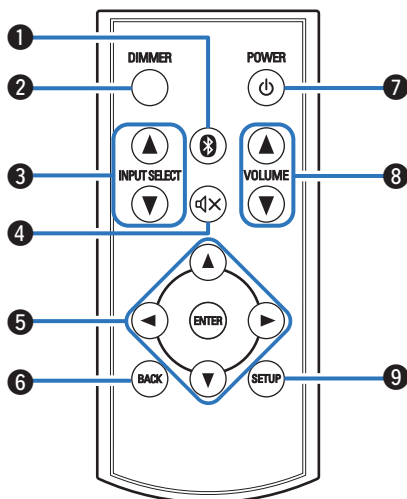

1 Bluetooth button (📶)

This switches the input to Bluetooth. This is also pressed during the pairing operation. (👉 p. 38)

2 DIMMER button

Adjust the display brightness of this unit.

3 INPUT SELECT ▲▼

This switches input sources. (👉 p. 25)

4 Mute button (🔇)

This mutes the output audio. (👉 p. 26)

5 Cursor buttons (▲▼◀▶)

These select menu items.

6 BACK button

Returns to the previous item.

7 Power operation button (🔌)

This turns the power on/to standby. (👉 p. 24)

8 VOLUME buttons (VOLUME ▲▼)

These adjust the volume level. (👉 p. 26)

9 SETUP button

The setting menu is displayed on the display.



Connections

■ Contents

Installing this unit	12
Installing horizontally	12
Installing vertically	13
Before using the remote control unit	15
Connecting speakers	17
Connecting to a device with analog audio output connectors	19
Connecting to a device with digital audio output connectors	20
Connecting a PC or Mac	21
Connecting the power cord	22

NOTE

- Do not plug in the power cord until all connections have been completed.
- Do not bundle power cords together with connection cables. Doing so can result in humming or noise.

■ Cables used for connections

Provide necessary cables according to the devices you want to connect.

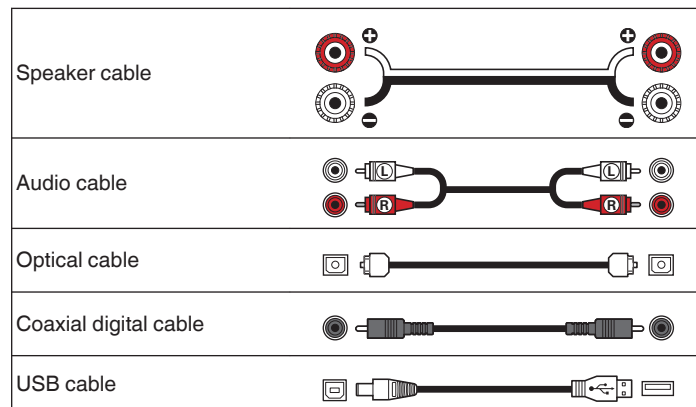

Installing this unit

This unit can be installed in two ways - horizontally or vertically. You can select how to install this unit according to the installation place and your preference.

Installing horizontally

The feet are initially attached to the unit for horizontal installation.

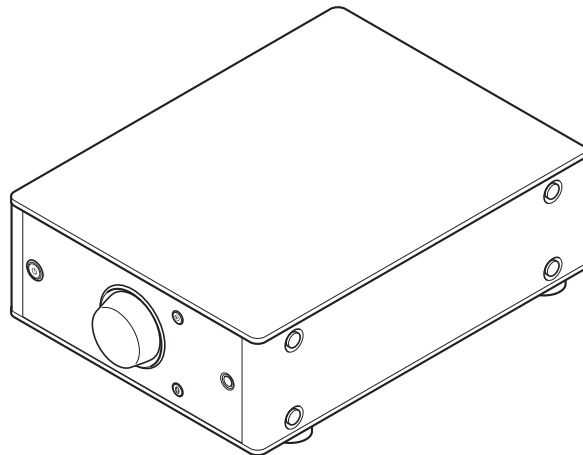

Installing vertically

This orientation is suitable for placing a narrow place such as a place next to a laptop computer.

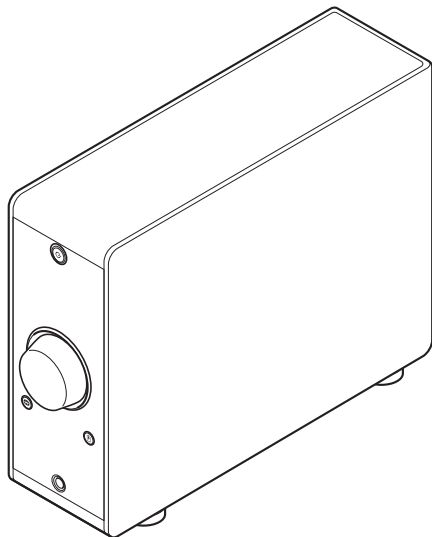

1 Remove the feet.

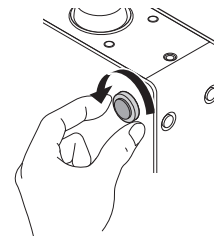

- Rotate each of the 4 feet counter-clockwise to remove.

2 Insert the supplied caps (silver) into the holes from which the feet were removed.

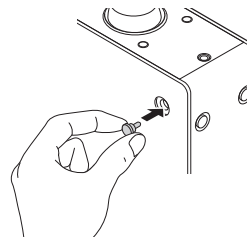

3 Remove the cap (black).

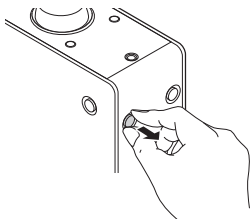

NOTE

Be careful not to damage your nails when removing the caps. If necessary, use a thin-tipped tool to remove the caps. However, be careful not to damage the unit when using tools.

4 Rotate the removed feet clockwise to attach them.

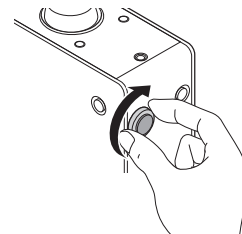

NOTE

After attaching the feet, adjust the height of the feet as necessary so that the set is stable when installed.



Before using the remote control unit

The remote control unit has a built-in lithium battery.
Pull out the insulation sheet before use.



■ Replacing the battery

1. Insert a pointed object into the hole in the battery case and pull out the battery tray.

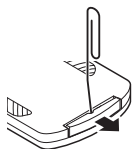

2. Insert the lithium battery correctly into the battery compartment as indicated.
3. Replace the battery case in the original position.

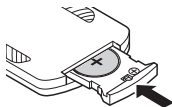

NOTE

- When inserting the lithium battery, be sure to do so in the proper direction, following the ⊕ and ⊖ marks in the battery compartment.
- If the battery should have a leakage, immediately replace and dispose of the battery. In this case, there is a risk of burn when the liquid comes in contact with skins or clothes, so a great care should be taken. If the liquid accidentally comes in contact, wash with tap water and consult a doctor.
- Remove the battery from the remote control unit if it will not be in use for long periods.



Operating range of the remote control unit

Point the remote control unit at the remote sensor when operating it.

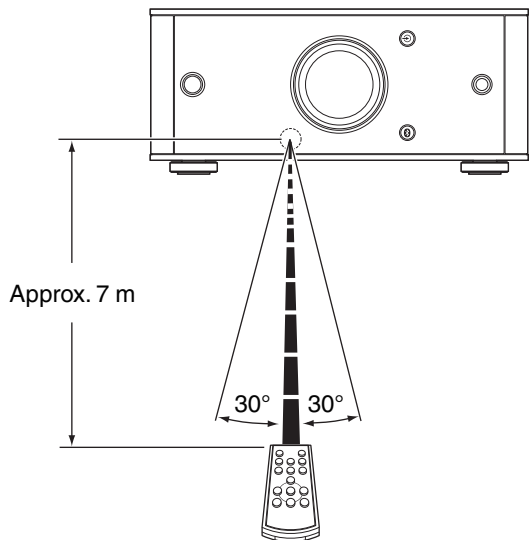

[Horizontal installation]

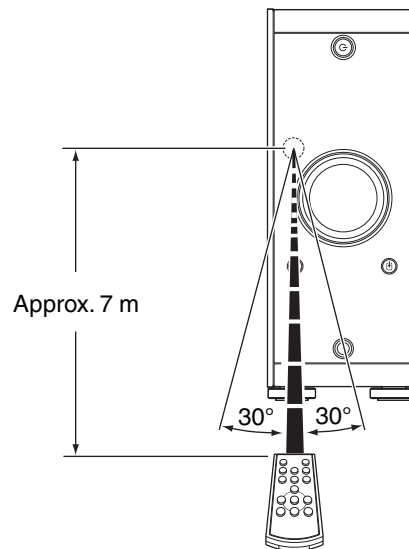

[Vertical installation]

Connecting speakers

NOTE

- Disconnect this unit's power plug from the power outlet before connecting the speakers. Also, turn off the subwoofer.
- Connect so that the speaker cable core wires do not protrude from the speaker terminal. The protection circuit may be activated if the core wires touch the rear panel or if the + and - sides touch each other. ("Connecting the speaker cables" (☞ p. 17))
- Never touch the speaker terminals while the power cord is connected. Doing so could result in electric shock.
- Use speakers with impedance of 4 - 16 Ω /ohms.

■ Connecting the speaker cables

Carefully check the left (L) and right (R) channels on the speakers being connected to this unit, and be sure to connect the polarities correctly.

- 1 Peel off about 10 mm of sheathing from the tip of the speaker cable, then either twist the core wire tightly or terminate it.



- 2 Turn the speaker terminal counterclockwise to loosen it.

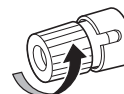

- 3 Insert the speaker cable's core wire to the hilt into the speaker terminal.

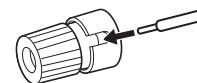

- 4 Turn the speaker terminal clockwise to tighten it.

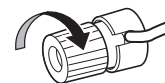

Speaker connection

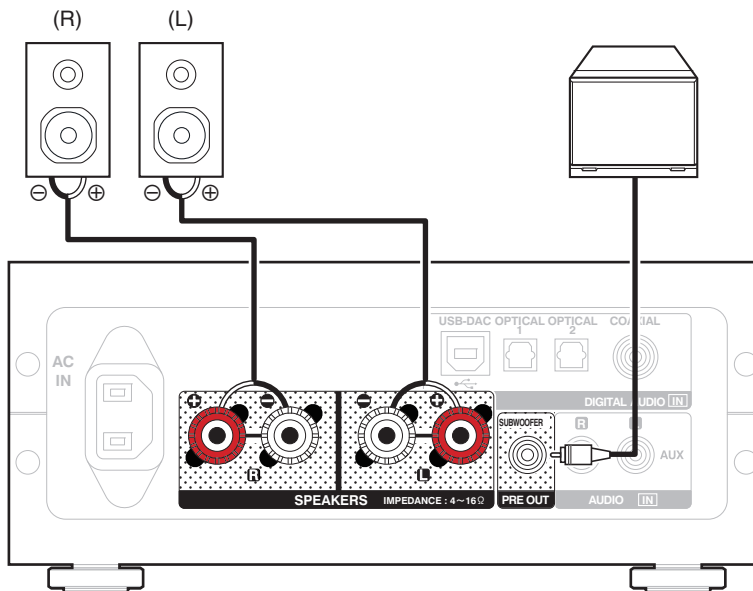

Connecting to a device with analog audio output connectors

This unit can be connected to an analog device such as a CD player.

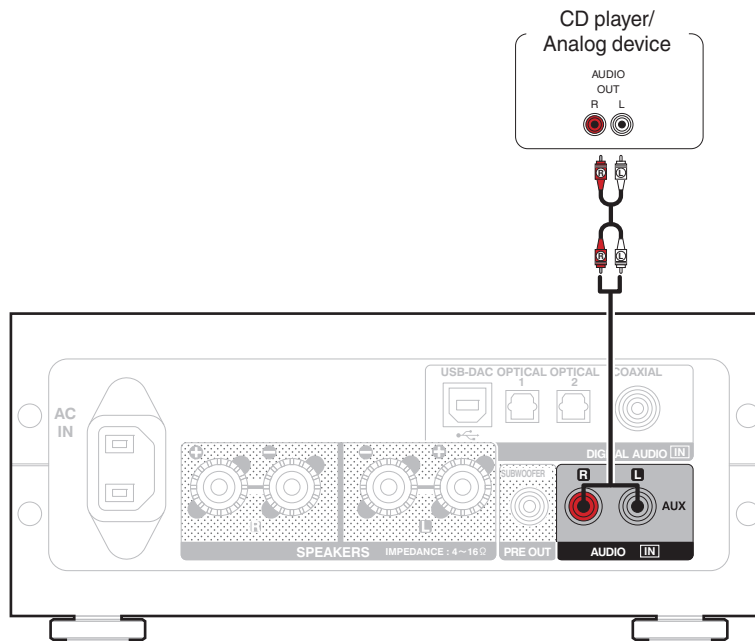

Connecting to a device with digital audio output connectors

Use this connection to input digital audio signals to this unit, and convert the signals for playback using the D/A converter of this unit. (☞ p. 27)

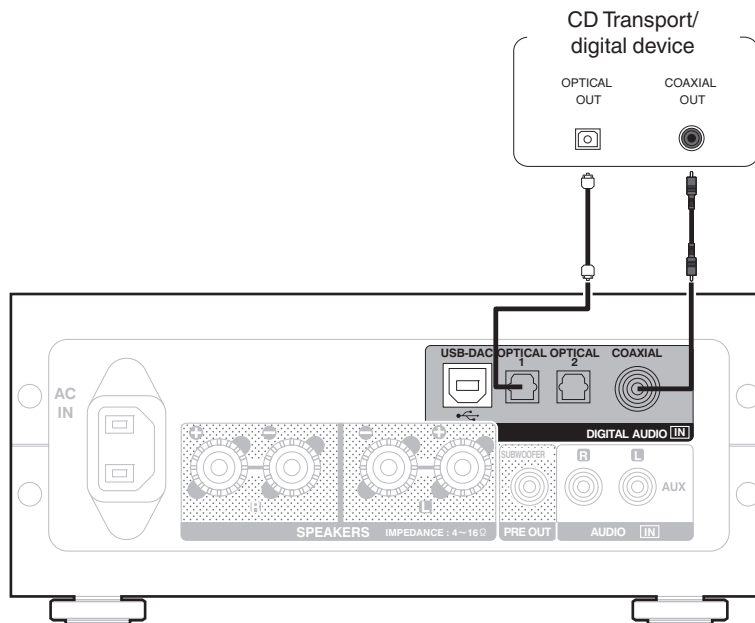

NOTE

- Linear PCM signals with a sampling frequency of 32 kHz, 44.1 kHz, 48 kHz, 64 kHz, 88.2 kHz, 96 kHz, 176.4 kHz, or 192 kHz can be input into this device.
- Do not input non-PCM signals, such as DTS and AAC. This causes noise and could damage the speakers.



Connecting a PC or Mac

By connecting a computer to the USB-DAC port on the rear panel of this unit using a commercially available USB connecting cable (supplied), this unit can be used as a D/A converter. (📖 p. 27)

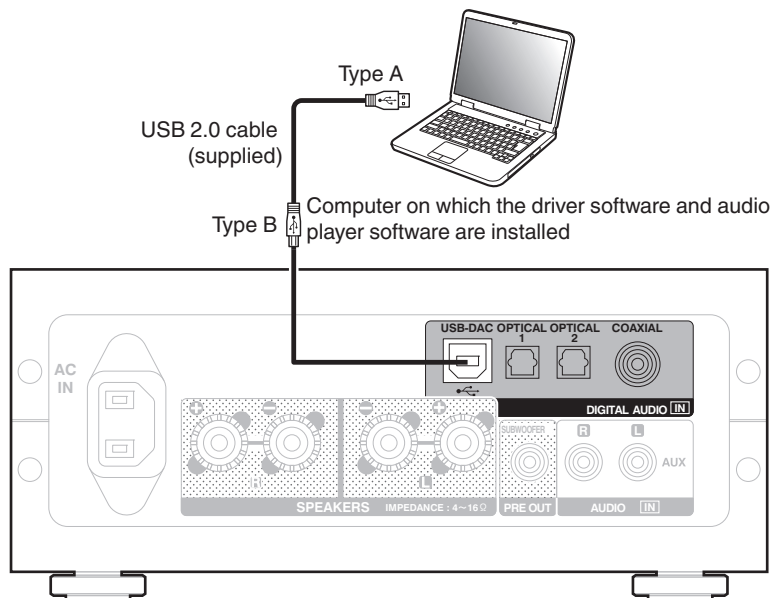

- Before USB connecting this unit to your computer, install the driver software in your computer. (📖 p. 27)
- Download the driver software from the PMA-50 page of the Denon website.

NOTE

Use a cable that is 3 m or less to connect to the computer.



Connecting the power cord

Wait until all connections have been completed before connecting the power cord.

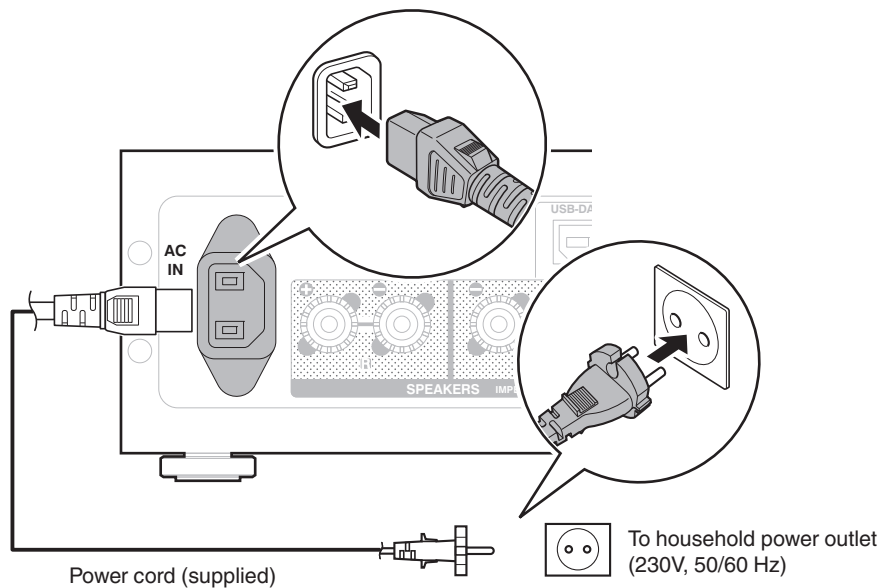

■ Contents

Basic operation

Turning the power on	24
Selecting the input source	25
Adjusting the master volume	26
Switching the display's brightness	26

Playing a device

Playing music on a computer (USB-DAC)	27
Listening to music via a digital connection (COAXIAL/OPTICAL-1/ OPTICAL-2)	35
Listening to music via a analog connection (ANALOG IN)	
Listening to music via a analog connection (AUX)	36
Listening to music on a Bluetooth device	37



Basic operation

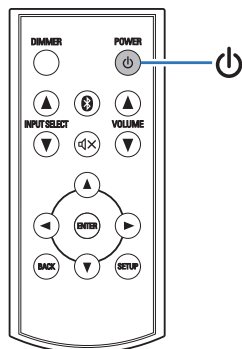
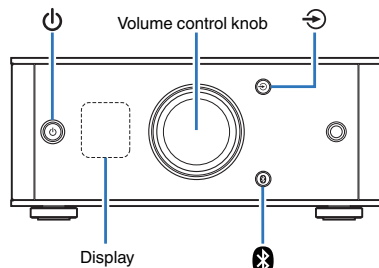

Turning the power on

1 Press to turn on power to this unit.

Turns the display on.

■ Switching power to the standby mode

1 Press .

Turns the display off.



You can also press  on the remote control unit for this operation.

NOTE

When the power is in the standby mode, some circuits are electrified. Before you go out or travel for a long period of time, disconnect the power cord from the power outlet.



Selecting the input source

■ Selecting USB-DAC, DIGITAL IN or ANALOG IN

1 Press to select the input source to be played.

The following icon appears on the display.



USB-DAC: Plays back audio on the computer.



COAXIAL: Plays back the device connected to the COAXIAL connector.



OPTICAL 1: Plays back the device connected to the OPTICAL 1 connector.



OPTICAL 2: Plays back the device connected to the OPTICAL 2 connector.



AUX: Plays back the device connected to the AUX connector.



You can also press INPUT SELECT  on the remote control unit for this operation.

■ Selecting Bluetooth

1 Press .

The following icon appears on the display.



Bluetooth: Connects and plays back a Bluetooth device.



You can also press  on the remote control unit for this operation.



Adjusting the master volume

1 Turn the volume control knob to adjust the volume.

The volume level appears on the display.



- You can also press VOLUME ▲▼ on the remote control unit for this operation.
- You can adjust the volume level to --- dB (minimum) and between -90 dB and 0 dB.

■ Turning off the sound temporarily (muting)

1 You can also press on the remote control unit.

MUTING is displayed on the display.

- Press  again to cancel the muting.

Switching the display's brightness

The display brightness can be adjusted between three levels.

1 Press DIMMER.



Playing a device

Connect the device you want to play back beforehand.
("Connections" (🔗 p. 11))

Playing music on a computer (USB-DAC)

You can enjoy high-quality audio playback from the D/A converter built in to this unit by inputting music files into this unit from a computer via USB connection.

- Before USB connecting this unit to your computer, install the driver software in your computer.
- Drivers do not need to be installed for Mac OS.
- Also, you can use whichever commercially available or downloadable player software you like to playback files on your computer.

■ Computer (recommended system)

OS

- Windows® Vista, Windows 7 or Windows 8/8.1
- Mac OS X 10.6.3 or later

USB

- USB 2.0: USB High speed/USB Audio Class Ver.2.0

NOTE

This unit was checked the operation using the recommended system by us, but it does not guarantee the operation of all systems.

- **DSD is a registered trademark.**
- **Microsoft, Windows Vista, Windows 7 and Windows 8 are either registered trademarks or trademarks of Microsoft Corporation in the United States and/or other countries.**
- **Apple, Macintosh and Mac OS are trademarks of Apple Inc., registered in the U.S. and other countries.**

Windows OS Installing the dedicated driver (🔗 p. 28)

Mac OS Audio Device Settings (🔗 p. 33)



■ Installing the dedicated driver (Windows OS only)

□ Installing the driver software

- 1 Disconnect the USB cable between your PC and the unit.**
 - The driver software cannot be installed correctly if your PC is connected to the unit by a USB cable.
 - If the unit and your computer are connected by a USB cable and the computer is switched on before installation, disconnect the USB and restart the computer.
- 2 Download the dedicated driver from the “Download” section of the PMA-50 page of the Denon website onto your PC.**
- 3 Unzip the downloaded file, select the 32-bit or 64-bit exe file that matches your Windows operating system, and double-click the file.**

4 Install the driver.

- ① Select the language to use for the installation.
- ② Click “OK”.



- ③ The wizard menu is displayed. Click “Next”.

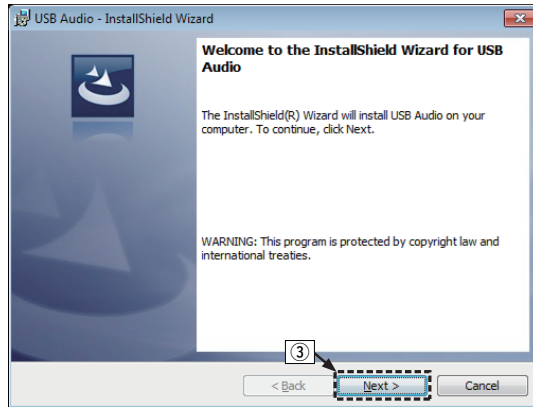

- ④ Read the Software Licensing Agreement, and click “I accept the terms in the license agreement”.
- ⑤ Click “Next”.



- ⑥ Click “Install” on the installation start dialog.
- The installation starts. Do not perform any operation on the PC until the installation is completed.

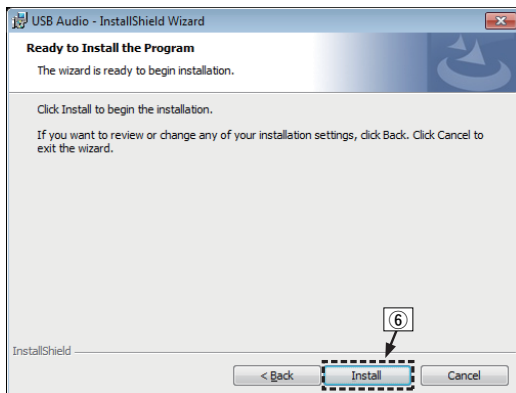

- ⑦ In the Windows security dialog, select “Always trust software from “DandM Holdings Inc.””.
- ⑧ Click “Install”.



- ⑨ When the installation is completed, click “Finish”.

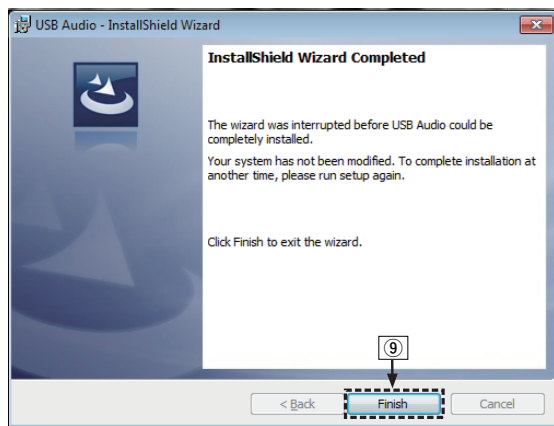

5 With the unit power off, connect the unit and PC using a USB cable (supplied).

- For the connection procedure, refer to the “Connecting a PC or Mac” (🔗 p. 21) section.

6 Press POWER ⏻.

- When the unit power is turned on, the PC automatically finds and connects to the unit.

7 Press the input source select button (USB-DAC) to switch the input source to “USB-DAC”.

8 Checking the installed driver.

- ① Click the “Start” button and click “Control Panel” on the PC.
 - The control panel setting list is displayed.
- ② Click the “Sound” icon.
 - The sound menu window is displayed.
- ③ Check that there is a checkmark next to “Default Device” under in “Digital Audio Interface” of the “Playback” tab.
 - When there is a checkmark for a different device, click Denon USB Audio and “Set Default”.



9 Checking audio output.

Outputs a TEST signal from the PC and checks the audio output from the USB-DAC function.

- ① Select “Digital Audio Interface” and click “Properties”.
 - The Digital Audio Interface Properties window is displayed.

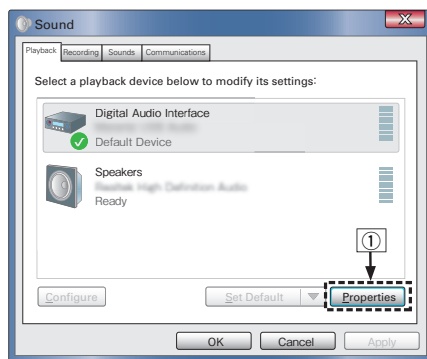

- ② Click the “Advanced” tab.
- ③ Select the sampling rate and bit rate to be applied to the D/A converter.
 - It is recommended that “2 channel, 24 bit, 192000 Hz (Studio Quality)” is selected.
- ④ Click “Apply”.
- ⑤ Click “Test”.
 - Check that audio from this unit is output from the PC.

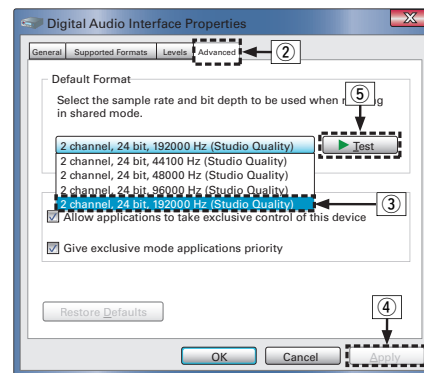

NOTE

- The dedicated driver must be installed in the PC before this unit is connected to a PC. Operation will not occur correctly if connected to the PC before the dedicated driver has been installed.
- Operation may fail in some PC hardware and software configurations.



■ Audio Device Settings (Mac OS X only)

- ① Move the cursor to “Go” on the computer screen, and then click “Utilities”.
 - The utility list is displayed.
- ② Double-click “Audio MIDI Setup”.
 - The “Audio Devices” window is displayed.
- ③ Check that “Use this device for sound output” is checked in “PMA-50”.
 - If a different device is checked, select and “Secondary click” on “PMA-50”, and then select “Use this device for sound output”.

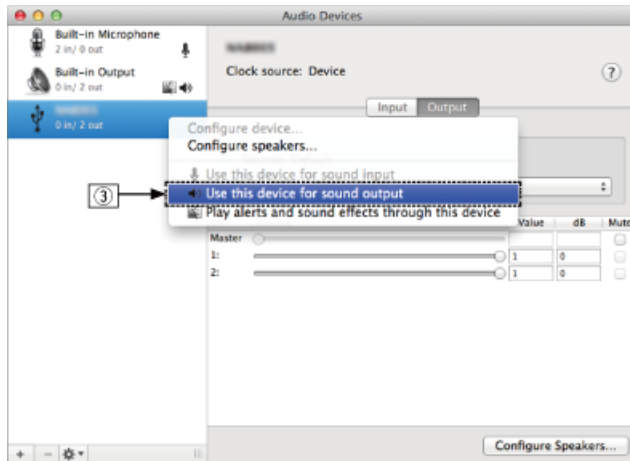

- ④ Select the “PMA-50” format.
 - It is normally recommended to set the format to “192000.0 Hz” and “2ch-24 bit Interger”.

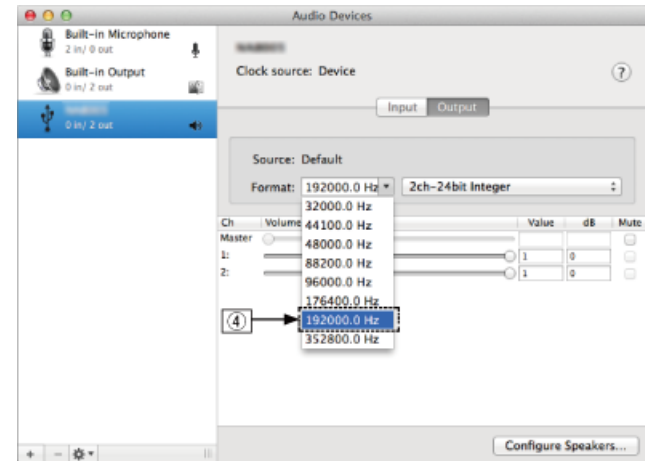

- ⑤ Quit Audio MIDI Setup.



■ Playback

Install the desired player software on your computer beforehand.
Use the rear panel USB-DAC port to connect this unit to a computer.
( p. 21)

1 Press to switch the input source to “USB-DAC”.

Start playback on the computer's player software.

The digital audio signal that is being input is shown as follows in the display.



You can also press INPUT SELECT ▲▼ on the remote control unit for this operation.

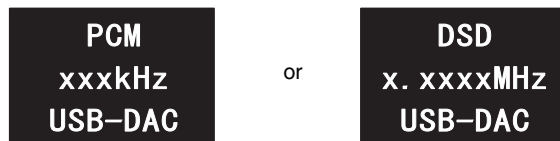

(xxxx is the sampling frequency.)

- If the sampling frequency cannot be detected, “Unlocked” will be displayed.
- “Unsupported” is displayed when audio signals that are not supported by this unit are input.

■ Files that can be played back

See “D/A Converter” ( p. 59).

NOTE

- Perform operations such as playback and pause on the computer. At this time, you cannot perform operations with buttons on this unit or the remote control.
- You can also control the volume and equalizer on the computer. Enjoy playing music at the desired volume.
- When this unit is functioning as a D/A converter, sound is not output from the computer's speakers.
- If the computer is disconnected from this unit while the computer music playback software is running, the playback software may freeze. Always exit the playback software before disconnecting the computer.
- When an error occurs on the computer, disconnect the USB cable and restart the computer.
- The sampling frequency of the music playback software and sampling frequency displayed on this unit may differ.
- Use a cable that is 3 m or less to connect to the computer.



Listening to music via a digital connection (COAXIAL/OPTICAL-1/OPTICAL-2)

1 Press to switch the input source to “COAXIAL”, “OPTICAL-1” or “OPTICAL-2”.

The digital audio signal that is being input is shown as follows in the display.



You can also press INPUT SELECT   on the remote control unit for this operation.



(xxxx is the sampling frequency.)

- If the sampling frequency cannot be detected, “Unlocked” will be displayed.
- “Unsupported” is displayed when audio signals that are not supported by this unit are input.

Files that can be played back

See “D/A Converter” ( p. 59).

NOTE

- Do not input non-PCM signals, such as Dolby Digital, and DTS. This causes noise and could damage the speakers.
- If the sampling frequency switches, such as from A mode to B mode in a CS broadcast, muting may operate for 1 – 2 seconds, cutting the sound.



Listening to music via a analog connection (AUX)

- 1** Press  to switch the input source to “AUX”.
- 2** **Play back music on the connected device.**
The speakers output music from the connected device.



Listening to music on a Bluetooth device

You can listen to music wirelessly by connecting this unit to a Bluetooth device via Bluetooth.

■ Pairing

Pairing (registration) is an operation that is required in order to connect a Bluetooth device to this unit using Bluetooth. When paired, the devices authenticate each other and can connect without mistaken connections occurring.



When using Bluetooth connection for the first time, you need to pair this unit and the Bluetooth device to be connected. This unit can store pairing information for a maximum of 8 devices.

NOTE

You cannot simultaneously output music from multiple Bluetooth devices.

■ How to establish a Bluetooth connection

There are three types of Bluetooth connection methods. Use an appropriate type depending on your environment.

- Case 1 Pairing with this unit for the first time
( p. 38)
- Case 2 Connecting a Bluetooth device that this unit performed pairing for before
( p. 41)
- Case 3 Connecting a Bluetooth device with the NFC function via NFC
( p. 42)



■ Case 1: Pairing with this unit for the first time

1 Press to turn on power to this unit.

Turns the display on.

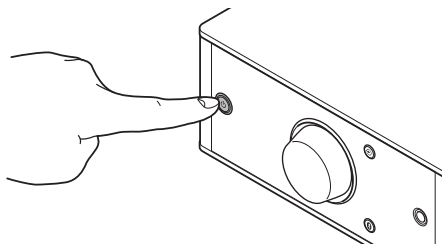

2 Turn on the Bluetooth function on the Bluetooth device.

- For details, see the owner's manual for your Bluetooth device.

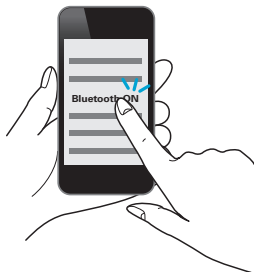

3 Press for 3 seconds or longer.

"Pairing" appears on the display, and the unit enters the pairing mode.

- When you press  for the first time after purchase, this unit automatically enters the pairing mode.

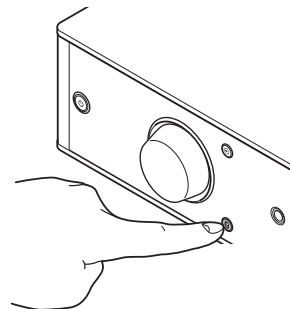

4 Select “Denon PMA-50” from the list of devices displayed in the screen on the Bluetooth device.

When pairing is complete and the device is connected via Bluetooth, the device name appears on the display of this unit.

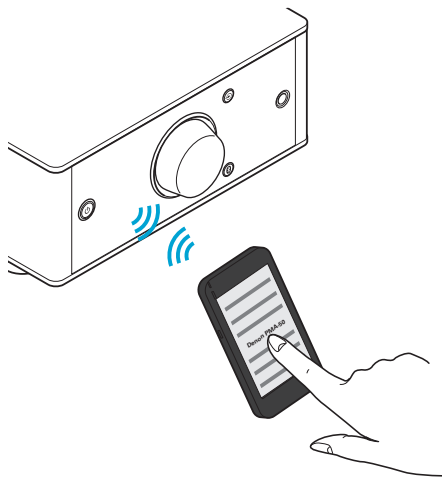

- When “Denon PMA-50” is not displayed in the screen on the Bluetooth device, search for devices on the Bluetooth device.
- When you are prompted for a pass key in the screen on the Bluetooth device, enter “0000”.
- English letters, numbers and certain symbols are displayed. Incompatible characters are displayed as “.” (period).



5 Play back music on the Bluetooth device.

The speakers output music that the Bluetooth device is playing back.



- Adjust to the appropriate volume level.
- When the pairing fails, retry from step 3.
- To perform pairing for another Bluetooth device, repeat steps 2 to 5 for each device you want to perform pairing for.
- When no Bluetooth device is connected, “No Connection” appears on the display.

NOTE

- The pairing mode on this unit lasts for approx. 5 minutes. When the pairing mode on this unit is canceled before the pairing is completed, retry from step 3.
- This unit cannot perform pairing against a Bluetooth device with a pass key other than “0000”.



■ Case 2: Connecting a Bluetooth device that this unit performed pairing for before

1 Turn on the Bluetooth function on the Bluetooth device.

- For details, see the owner's manual for your Bluetooth device.

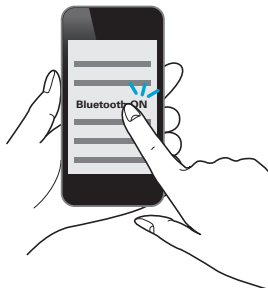

2 Select "Denon PMA-50" from the list of devices displayed in the screen on the Bluetooth device.

Power to this unit is automatically turned on and this unit attempts to establish the Bluetooth connection. When the device is connected via Bluetooth, the device name appears on the display of this unit.

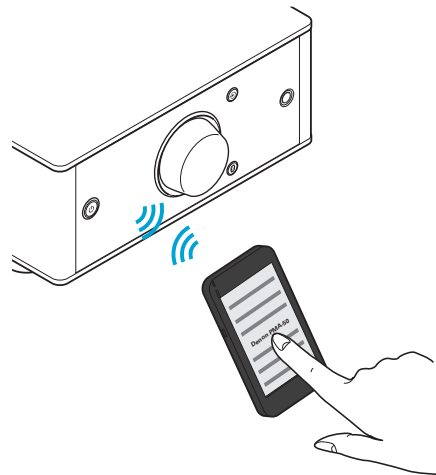

3 Play back music on the Bluetooth device.

The speakers output music from the Bluetooth device.

■ Case 3: Connecting a Bluetooth device with the NFC function via NFC

You can just touch this unit with a Bluetooth device to turn on power to this unit and perform pairing or establish a connection between this unit and the Bluetooth device.

1 Turn on the NFC function on the Bluetooth device.

- For details, see the owner's manual for your Bluetooth device.

2 Touch **N** on this unit with the NFC antenna part on the Bluetooth device.

Power to this unit is turned on and this unit attempts to establish the Bluetooth connection.

When the device is connected via Bluetooth, the device name appears on the display of this unit.

- Complete operations as instructed by the Bluetooth device.

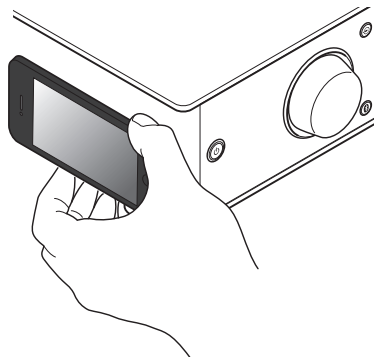

3 Play back music on the Bluetooth device.

This unit outputs music from the Bluetooth device.



- When you touch the N mark (N) on this unit with the Bluetooth device that is playing back music, this unit outputs that music.
- Touch the N mark (N) again during the Bluetooth connection to disconnect the connection.
- When you touch the N mark (N) with a different Bluetooth device during the Bluetooth connection, this unit stops playing back for the currently connected Bluetooth device and connects to the newly touched Bluetooth device.

NOTE

- Before establishing a NFC connection, cancel the lock function on the Bluetooth device.
- When you touch this unit with a Bluetooth device, do so softly.



■ Simultaneously connecting multiple Bluetooth devices (multi point function)

This unit can only output music from one connected Bluetooth device, but up to 3 Bluetooth devices can simultaneously be connected.

("Listening to music on a Bluetooth device" (☞ p. 37))

If frequently used devices are connected, it is useful for switching the playback device because you do not have to reconnect them.

Perform pairing for devices you want to connect to beforehand.

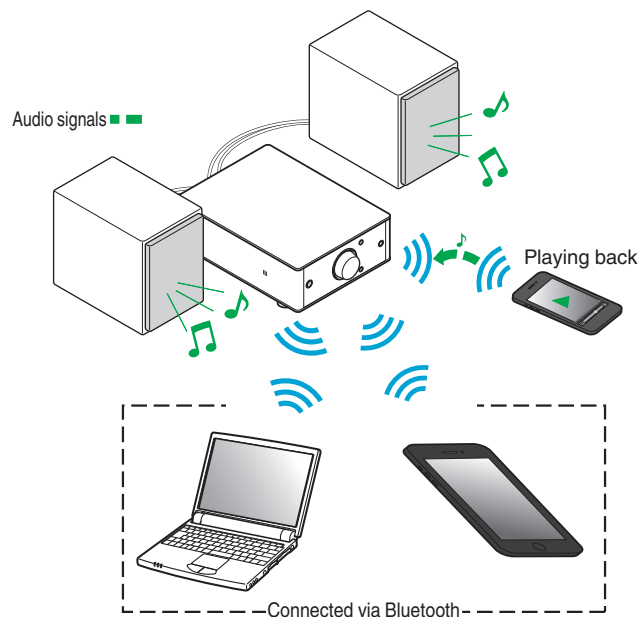

■ Switching the playback device

- 1** Stop or pause the device that is currently played back.
- 2** Play back the device that you want to output music from.



Turn the power of this unit to standby before turning the Bluetooth function of the Bluetooth device off.



Menu map

For menu operations, see the following page.

By default, this unit has recommended settings defined. You can customize this unit based on your existing system and your preferences.

Setting items	Description	Page
Source Direct	Sets the tone adjustment.	47
Bass	Adjusts the bass sound.	47
Treble	Adjusts the treble sound.	47
Balance	Adjust the left/right volume balance.	47
H/P AMP Gain	Set the gain of the headphone amplifier.	47
Bluetooth	Switches the Bluetooth function on/off.	48
Auto Standby	When there is no input signal and operation for 30 minutes, this unit automatically enters the standby mode.	48



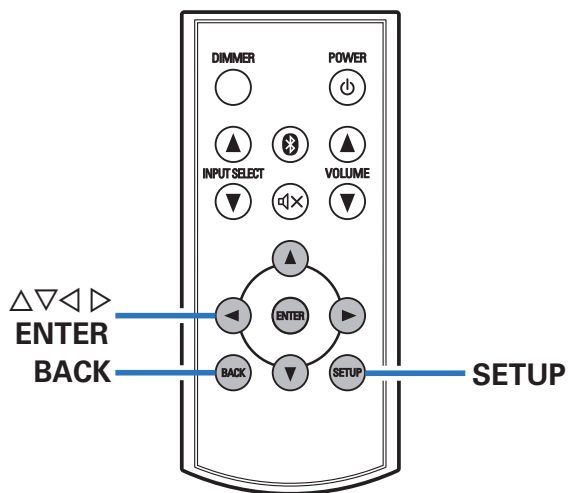

■ Menu operation

1 Press **SETUP**.

The menu is displayed on the display.

2 Use $\Delta \nabla$ to select the menu to be set or operated, then press **ENTER**.

3 Use $\Delta \nabla \triangleleft \triangleright$ to change to desired setting.

4 Press **ENTER** to enter the setting.

- To return to the previous item, press **BACK** or \triangleleft .
- Exiting the Menu, press **SETUP** while the menu is displayed. The display returns to the normal display.



Source Direct

Set whether to adjust the tone.

Off (Default):	Adjusting the tone.
On:	Tone is not adjusted. Tone adjustments (Bass, Treble, Balance) are disabled.

Bass

Adjusts the bass sound.

-8dB – +8dB (Default : 0dB)

Treble

Adjusts the treble sound.

-8dB – +8dB (Default : 0dB)

Balance

Use <|> to adjust the left/right volume balance.

H/P AMP Gain

Set the gain of the headphone amplifier. Set this according to the impedance of the connected headphones. It is recommended that this is set on the “Low” side if the headphones have low impedance and on the “High” side if they have high impedance.

Low (Default):	Set the gain of the headphone amplifier to “Low”.
Mid:	Set the gain of the headphone amplifier to “Mid”.
High:	Set the gain of the headphone amplifier to “High”.

NOTE

The headphone volume varies depending on the “H/P AMP Gain” setting. Decrease the volume or mute the audio first if changing this setting while listening to audio.



Bluetooth

Stopping Bluetooth function reduces a source of noise that affects sound quality, enabling higher sound quality playback.

On
(Default): Enables the Bluetooth function.

Off: Disables the Bluetooth function.



When Bluetooth is “Off”, the input source cannot be switched to Bluetooth.

Auto Standby

When there is no input signal and operation for 30 minutes, this unit automatically enters the standby mode.

On
(Default): The unit goes into standby after 30 minutes.

Off: The unit does not go into standby automatically.



■ Contents

Tips

I want to turn on power to this unit from a Bluetooth device	50
I want to switch the connection to a different Bluetooth device	50
I want to connect to an NFC enabled device via NFC	50
I want to adjust the tone myself	50
I want sound playback that is faithful to the original sound	50

Troubleshooting

Power does not turn on / Power is turned off	52
No sound comes out	53
Sound is distorted or interrupted, or noise occurs	54
Desired sound does not come out	54
Files on a computer cannot be played back	55
Audio from digital devices cannot be played back (Coaxial/Optical)	56
Pairing fails	56
NFC connection fails	56
Operations cannot be performed through the remote control unit	57
The Bluetooth device names are not displayed properly	57



Tips

I want to turn on power to this unit from a Bluetooth device

- Once you perform pairing between this unit and a Bluetooth device, you can turn on power to this unit by operating the Bluetooth device. Select “PMA-50” from the list of Bluetooth devices to turn on power to this unit.

I want to switch the connection to a different Bluetooth device

- This unit can only output music from one connected Bluetooth device, but up to 3 Bluetooth devices can simultaneously be connected. To switch the connection easily, always have the frequently used Bluetooth devices connected. When multiple Bluetooth devices are connected and you want to switch to a different Bluetooth device, stop playback on the device that is currently played back and play back the Bluetooth device that you want to output music from. (👉 p. 44)

I want to connect to an NFC enabled device via NFC

- Enable the NFC function on an NFC enabled device, and touch the N mark (N) on this unit with the NFC device. (👉 p. 42)

I want to adjust the tone myself

- Adjust the “Bass”, “Treble” and “Balance” in the setup menu to the desired levels.

I want sound playback that is faithful to the original sound

- Set “Source Direct” in the setup menu to “On”.



Troubleshooting

1. **Are the connections correct?**
2. **Is the set being operated as described in the owner's manual?**
3. **Are the other devices operating properly?**

If this unit does not operate properly, check the corresponding symptoms in this section.

If the symptoms do not match any of those described here, consult your dealer as it could be due to a fault in this unit. In this case, disconnect the power immediately and contact the store where you purchased this unit.



■ Power does not turn on / Power is turned off

Symptom	Cause / Solution	Page
Power does not turn on.	• Check whether the power cord is correctly inserted into the power outlet.	<u>22</u>
	• Check the connection between this unit and the power cord.	<u>22</u>
	• This unit is in the standby mode. Press the power button (⏻).	<u>24</u>
	• Use the power cord that is supplied with this unit.	<u>22</u>
Power automatically turns off.	• The auto standby mode is on. When approx. 30 minutes pass with no audio input, this unit automatically enters the standby mode. To turn Auto Standby mode off, set "Auto Standby" on the setup menu to "Off".	<u>48</u>
Power turns off and the protection circuit indicator flashes in red approx. every 2 seconds.	• The protection circuit has been activated due to a rise in temperature within this unit. Turn the power off, wait about an hour until this unit cools down sufficiently, and then turn the power on again.	<u>24</u>
	• Please re-install this unit in a place having good ventilation.	—
Power turns off and the protection circuit indicator flashes in red approx. every 0.5 seconds.	• Check the speaker connections. The protection circuit may have been activated because speaker cable core wires came in contact with each other or a core wire was disconnected from the connector and came in contact with the rear panel of this unit. After unplugging the power cord, firmly re-twist the core wire, and then reconnect the wire.	<u>17</u>
	• Turn down the volume and turn on the power again.	<u>24</u>
	• This unit's amplifier circuit has failed. Unplug the power cord and contact our customer service center.	—



■ No sound comes out

Symptom	Cause / Solution	Page
Audio is not output.	• Check the connections for all devices.	<u>17</u>
	• Check the sound settings on the computer.	<u>27</u>
	• Insert connection cables all the way in.	—
	• Check that the covered part of the speaker cable is not inserted into the speaker terminal.	<u>17</u>
	• Check cables for damage.	—
	• Check that a proper input source is selected.	<u>25</u>
	• Check that power to this unit and the connected devices is on.	—
	• Adjust to an appropriate volume level on this unit and the connected devices.	<u>26</u>
	• To playback via a Bluetooth connection, perform pairing between this unit and the Bluetooth device.	<u>37</u>
• When the muting mode is enabled, cancel the muting.	<u>26</u>	



■ Sound is distorted or interrupted, or noise occurs

Symptom	Cause / Solution	Page
Sound is distorted or interrupted, or noise occurs.	• Adjust to an appropriate volume level on this unit and the connected devices.	<u>26</u>
	• Place the device connected via Bluetooth closer to this unit.	—
	• Place this unit away from microwaves, wireless LAN devices, etc.	—
	• Turn off and on power to Bluetooth devices.	—
	• Turn down the volume of the playback device connected to the AUX connector.	—
	• Switch "H/P AMP Gain" to "Mid" or "High" if using headphones with high impedance or low sensitivity.	—
Sound is interrupted during playback of music from a computer.	• During playback of music from the computer, do not run any applications other than the player software.	—

■ Desired sound does not come out

Symptom	Cause / Solution	Page
No sound comes out of a specific speaker.	• Check that speaker cables are properly connected.	<u>17</u>
	• Adjust the BALANCE control knob.	<u>47</u>
The left and right of stereo sound is reversed.	• Check whether the left and right speakers are connected to the correct speaker terminals.	<u>18</u>



■ Files on a computer cannot be played back

Symptom	Cause / Solution	Page
This unit is not recognized on the computer.	• Reconnect the USB cable to the USB port on your computer. When this unit is still not recognized after reconnection, connect to a different USB port.	<u>21</u>
	• Restart your computer.	—
	• Check the OS of your computer.	<u>27</u>
	• When your computer is running on Windows, a dedicated driver software should be installed.	<u>28</u>
This unit is not selected as the playback device.	• Select this unit as the playback device in the sound settings on the computer.	<u>27</u>
“Unlocked” is displayed.	• When digital audio signals cannot be detected properly, “Unlocked” is displayed.	<u>27</u>
“Unsupported” is displayed.	• “Unsupported” is displayed when audio signals that are not supported by this unit are input. Check the settings on your computer or player software.	<u>27</u>
	• If the computer you use is “Mac OS”, please check if the “PMA-50” format is set below “192000.0 Hz” using the “Audio MIDI Setup”.	<u>33</u>



■ Audio from digital devices cannot be played back (Coaxial/Optical)

Symptom	Cause / Solution	Page
"Unlocked" is displayed.	<ul style="list-style-type: none"> When digital audio signals cannot be detected properly, "Unlocked" is displayed. 	<u>35</u>
"Unsupported" is displayed.	<ul style="list-style-type: none"> "Unsupported" is displayed when audio signals that are not supported by this unit are input. Check the audio output signal format from your digital device. 	<u>35</u>

■ Pairing fails

Symptom	Cause / Solution	Page
Pairing fails.	<ul style="list-style-type: none"> Turn off and on power to this unit. 	<u>24</u>
	<ul style="list-style-type: none"> Place the Bluetooth device within 1m of this unit and perform pairing again. 	<u>37</u>
	<ul style="list-style-type: none"> Search for devices from the list of the Bluetooth devices. 	—
	<ul style="list-style-type: none"> Turn off and on power to Bluetooth devices. 	—

■ NFC connection fails

Symptom	Cause / Solution	Page
NFC connection fails.	<ul style="list-style-type: none"> Check that the Bluetooth device has the NFC function. 	—
	<ul style="list-style-type: none"> Touch the N mark (N) on this unit, checking the location of the NFC antenna on the Bluetooth device. Touch surely until the Bluetooth device responds. 	<u>42</u>



■ Operations cannot be performed through the remote control unit

Symptom	Cause / Solution	Page
Operations cannot be performed through the remote control unit.	• Batteries are worn out. Replace with new batteries.	<u>15</u>
	• Operate the remote control unit within a distance of about 7 m from this unit and at an angle of within 30°.	<u>16</u>
	• Remove any obstacle between this unit and the remote control unit.	—
	• Insert the batteries in the proper direction, checking the ⊕ and ⊖ marks.	<u>15</u>
	• The set's remote control sensor is exposed to strong light (direct sunlight, inverter type fluorescent bulb light, etc.). Move the set to a place in which the remote control sensor will not be exposed to strong light.	—
	• When using a 3D video device, the remote control unit of this unit may not function due to effects of wireless communications between units (such as TV and glasses for 3D viewing). In this case, adjust the direction of units with the 3D communications function and their distance to ensure they do not affect operations from the remote control unit of this unit.	—

■ The Bluetooth device names are not displayed properly

Symptom	Cause / Solution	Page
The device names are not displayed properly (“...”, etc.).	• Characters that cannot be displayed have been used. On this unit, characters that cannot be displayed are replaced with a “.” (period).	—
	• The device address is displayed when the device name cannot be obtained.	—



Resetting to factory settings

Perform this when this unit does not operate properly.

Various settings are reset to the factory default values. Make settings again.

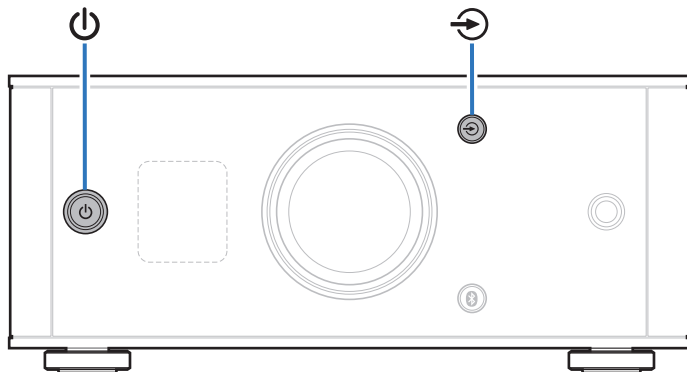

- 1** When this unit is in the standby mode, press  while holding .

“INITIALIZE” appears on the display and this unit restarts.

NOTE

Pairing information stored on this unit is also initialized. Perform pairing again.



Types of playable digital audio input signals

D/A Converter

■ Compatible formats

□ USB-DAC

	Sampling frequency	Bit length
DSD (2-channel)	2.8/5.6 MHz	1 bit
Linear PCM (2-channel)	32/44.1/48/88.2/96/ 176.4/192 kHz	16/24 bits

□ Coaxial/Optical

	Sampling frequency	Bit length
Linear PCM (2-channel)	32/44.1/48/64/88.2/96/ 176.4/192 kHz	16/24 bits

Playing back Bluetooth devices

This unit supports the following Bluetooth profiles.

- A2DP (Advanced Audio Distribution Profile) :

When a Bluetooth device that supports this specification is connected, you can perform high quality streaming distribution of monaural and stereo audio data.

- AVRCP (Audio/Video Remote Control Profile) :

When a Bluetooth device that supports this specification is connected, you can operate the Bluetooth device from this unit.

Bluetooth communications

The radio waves broadcast from this unit may interfere with operations on medical equipment. The radio wave interference may cause a malfunction. Therefore, make sure to turn off power to this unit and Bluetooth devices in the following places.

- Hospitals, trains, airplanes, gas stands, and other places where flammable gas may occur.
- Places near automatic doors and fire alarms.



Explanation of terms

Bluetooth

Technology for near field wireless communications. This unit can connect to Bluetooth devices wirelessly. To establish a Bluetooth connection, you must perform pairing (registering) beforehand.

DSD (Direct-Stream Digital)

One of the audio data recording methods, it is the signal aspect used to store audio signals on a super audio CD, and is $\Delta-\Sigma$ modulated digital audio. It is configured of an array of single bit values at a 2.8224MHz sampling rate.

NFC (Near Field Communication)

Technology for near field wireless communications. You can just touch this unit with a device with the NFC function to establish a connection between this unit and the device.

Sampling frequency

Sampling involves taking a reading of a sound wave (analog signal) at regular intervals and expressing the height of the wave at each reading in digitized format (producing a digital signal). The number of readings taken in one second is called the "sampling frequency". The larger the value, the closer the reproduced sound is to the original.

Pairing

Pairing (registration) is an operation that is required in order to connect a Bluetooth device to this unit using Bluetooth. When paired, the devices authenticate each other and can connect without mistaken connections occurring.

When using Bluetooth connection for the first time, you need to pair this unit and the Bluetooth device to be connected.

This unit can store pairing information for a maximum of 8 devices.

Protection circuit

This is a function to prevent damage to devices within the power supply when an abnormality such as an overload, excess voltage occurs or over temperature for any reason.

Linear PCM

Uncompressed PCM (Pulse Code Modulation) signals. Unlike lossy compression audio sources such as MP3, no audio quality or dynamic range deteriorates.



Trademark information



The Bluetooth® word mark and logos are registered trademarks owned by Bluetooth SIG, Inc. and any use of such marks by D&M Holdings Inc. is under license. Other trademarks and trade names are those of their respective owners.



The CSR logo is a trademark of CSR plc or one of its group companies.



The N Mark is a trademark or registered trademark of NFC Forum, Inc. in the United States and in other countries.



Adobe, the Adobe logo and Reader are either registered trademarks or trademarks of Adobe Systems Incorporated in the United States and/or other countries.



Specifications

■ Audio section

- Output performance

Rated output:

both channels driven

25 W+25 W (8 Ω /ohms, 1 kHz, T.H.D. 0.1 %)

50 W+50 W (4 Ω /ohms, 1 kHz, T.H.D. 1.0 %)

Output connectors:

Speaker: 4-16 Ω /ohms

Headphones: Φ 6.3 mm jack

Total harmonic distortion:

0.004 % (Digital in, Rated output -3 dB, 8 Ω /ohms, 1 kHz)

S/N ratio:

110 dB (Digital in, 25 W, 8 Ω /ohms, 1 kHz, IHF-A)

- Digital input signal

Audio formats:

Digital audio interface (Linear PCM)

Coaxial input:

0.5 Vp-p/50 Ω /ohms

Optical input:

More than -27 dBm

Wavelength:

660 nm

- Input performance

Input sensitivity/impedance:

AUX: 0.13 V / 22 k Ω /kohms



■ Bluetooth section

Communication system:	Bluetooth version 3.0
Transmission power:	Maximum 2.5 mW (Class2)
Maximum communication range:	Approx. 10 m in line of sight *
Frequency band:	2.4 GHz band
Modulation method:	FHSS (Frequency-Hopping Spread Spectrum)
Supported profiles:	A2DP 1.3/AVRCP 1.5
Supported codecs:	aptX Low Latency/AAC/SBC

* The actual communication range varies depending on the influence of such factors as obstructions between devices, electromagnetic waves from microwave ovens, static electricity, cordless phones, reception sensitivity, antenna performance, operating system, application software etc.

■ General

Power supply:	AC230 V, 50/60 Hz
Power consumption:	35 W
Power consumption in standby mode:	0.2 W

For purposes of improvement, specifications and design are subject to change without notice.



■ Dimensions

Unit : mm

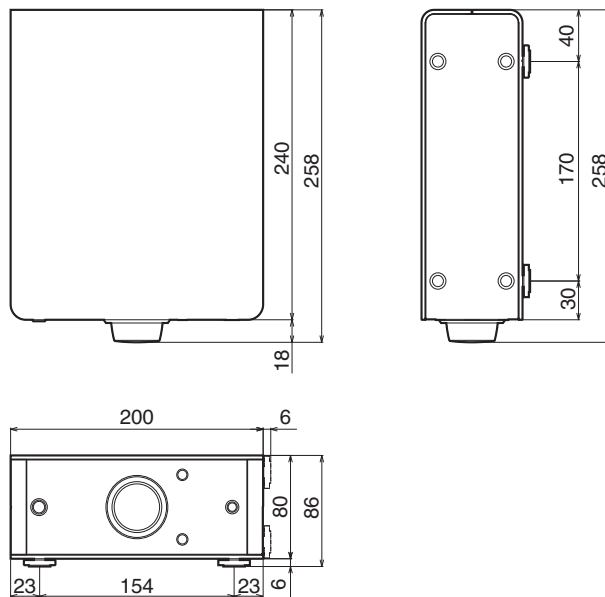

■ Weight: 2.5 kg

Index

A		I		R	
Accessories	4	Initialize	58	Rear panel	9
Adjusting the volume	26	Installing horizontally	12	Remote control unit	10
Auto Standby	48	Installing vertically	13		
C		L		S	
Computer (recommended system)	27	Linear PCM	60	Sampling frequency	60
Connecting a computer	21	Listening to music on a Bluetooth device	37	Selecting the input source	25
Connecting a power cord	22			Speaker connection	17
		M		Standby	24
D		Multi point function			
Display	8	N mark		T	
		NFC function		Troubleshooting	
		42, 60		Turning the power on	
				24	
F		P		U	
Front panel	6	Pairing		USB cable	
		37, 60		21	
		Protection circuit			
		60			





DENON®

www.denon.com

D&M Holdings Inc.
3520 10369 00AD