

DENON[®]

CEOL

NETWORK CD RECEIVER RCD-N12

Owner's Manual

[Front/Top panel](#)[Rear panel](#)[Remote control unit](#)[Index](#)

Accessories	7
Inserting the batteries	8
Operating range of the remote control unit	8
Part names and functions	9
Front/Top panel	9
Rear panel	12
Remote control unit	14

Connections

Connecting speakers	19
Connecting the speaker cables	19
Connecting speakers	20
Connecting the subwoofer	20
Connecting powered speakers	21
Connecting a digital device	22
Connecting an analog device	23
Connecting a USB flash drive to the USB port	24
Connecting an FM/AM antenna	25
Connecting to a home network (LAN)	27
Wired LAN	27
Wireless LAN	28
Connecting the power cord	29



Playback

Basic operation	31
Turning the power on	31
Switching the power to standby	31
Selecting the input source	32
Adjusting the volume	32
Turning off the sound temporarily (Muting)	32
Listening to Internet Radio	33
Listening to Internet Radio	34
Playing back files stored on PC or NAS	35
Playing back files stored on PC or NAS	36
Playing a USB flash drive	38
Playing files stored on USB flash drives	39
Listening to music on a Bluetooth device	41
Listening to music on a Bluetooth device	42
Pairing with other Bluetooth devices	43
Reconnecting to this unit from a Bluetooth device	44

Listening to audio on Bluetooth headphones	45
Listening to audio on Bluetooth headphones	46
Reconnecting to a Bluetooth headphones	47
Disconnecting Bluetooth headphones	47
Getting the HEOS app	48
Setting up the HEOS app for the first time with a HEOS built-in device	49
Adding the registration of HEOS built-in devices in the HEOS app	50
HEOS Account	51
Playing from streaming music services	52
Listening to the same music in multiple rooms	55
Playing CDs	59
Playing CDs	59
Playing tracks in a specific order (Program playback)	61
Playing DATA CDs	62
Playing files	63
Listening to FM/AM broadcasts	65
Listening to FM/AM broadcasts	65
Changing the reception mode (Tune Mode)	66
Presetting FM/AM stations	66
Automatically presetting FM stations (Auto Preset)	67
Listening to stations registered in the preset list	67
Deleting a station from the preset list	68



Playing digital input	69
Playing analog input	71
AirPlay function	72
Playing songs from your iPhone, iPod touch, iPad or Mac	73
Playing songs from Windows PC	73
Play a song from your iPhone, iPod touch, iPad or Mac on multiple synced devices (AirPlay 2)	74
Spotify Connect function	75
Playing Spotify music with this unit	75
Convenience functions	76
Playing back HEOS Favorites	77
Adding to HEOS Favorites	77
Deleting a HEOS Favorites	78
Switching the display's brightness	78
Using the sleep timer	79
Checking the current time	79
Quick select function	80

Settings

Menu map	81
Menu operation	83
Inputting characters	84
Using the number buttons	84
Using the cursor buttons	85
Audio	87
SDB/Tone	87
Volume Limit	87
H/P Amplifier Gain	88
Speaker Optimization	88
TV	89
TV Input	89
HDMI Power Off Control	90
General	91
Alarm	91
Clock	92
Clock Mode	93
IR Control	93
CD Auto Play	94
Language	94
Auto-Standby	94
Information	95
Reset	95



Network	96
Network Information	96
Wi-Fi	96
Bluetooth	97
Network Control	98
AirPlay Setup	98
Connecting to the network by using the WPS button on the router	99

Tips

Tips	101
Troubleshooting	103
Power does not turn on / Power is turned off	104
Light is flashing	104
Operations cannot be performed through the remote control unit	106
Display on this unit shows nothing	106
No sound comes out	107
Sound is interrupted or noise occurs	108
Desired sound does not come out	110
AirPlay cannot be played back	111
USB flash drives cannot be played back	112
File names on the USB flash drive are not displayed properly	113
Bluetooth cannot be played back	113



The Internet radio cannot be played back	116
Music files on PC or NAS cannot be played back (Music server)	117
Various online services cannot be played	118
Cannot connect to a wireless LAN network	118
Cannot playback Discs	119
Audio from digital devices cannot be played back (HDMI/Optical)	120
The input source switches to “HDMI” or “Optical”	120
The HDMI control function does not work	120
Update/upgrade error messages	121
Resetting network settings	122
Factory Restore	123

Appendix

Playing back Discs	124
Files	124
Playback order of music files	125
About discs and files	126
Playing back a USB flash drives	127
Cautions on using media	129
Inserting a disc	129
How to handle media	130
Cleaning discs	130
Digital input	131
Playing back a Bluetooth device	131
Playing back files stored on a PC and NAS	132
Playing back Internet Radio	133
Last function memory	133
About HDMI	134
Explanation of terms	135
Trademark information	139
Specifications	140
Index	146







Thank you for purchasing this Denon product.

To ensure proper operation, please read this owner's manual carefully before using the product.

After reading this manual, be sure to keep it for future reference.

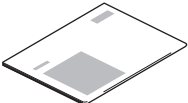
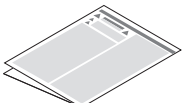
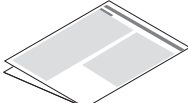
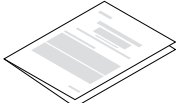
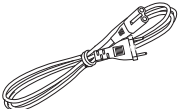
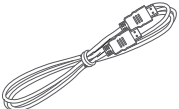
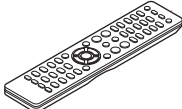
Accessories

Check that the following parts are included with the product.

 <p>Quick Start Guide</p>	 <p>Safety Instructions</p>	 <p>Notes on radio</p>	 <p>Warranty (for North America model only)</p>
 <p>Power cord</p>	 <p>HDMI cable</p>	 <p>Remote control unit (RC-1255)</p>	 <p>2x R03/AAA batteries</p>
 <p>FM indoor antenna</p>	 <p>AM loop antenna</p>		



Inserting the batteries

- 1 Remove the rear lid in the direction of the arrow and remove it.

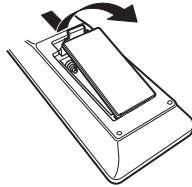

- 2 Insert two batteries correctly into the battery compartment as indicated.

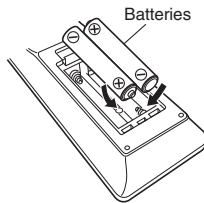

- 3 Put the rear lid back on.

NOTE

- To prevent damage or leakage of battery fluid:
 - Do not use a new battery together with an old one.
 - Do not use two different types of batteries.
- Remove the batteries from the remote control unit if it will not be in use for long periods.
- If the battery fluid should leak, carefully wipe the fluid off the inside of the battery compartment and insert new batteries.

Operating range of the remote control unit

Point the remote control unit at the remote sensor when operating it.

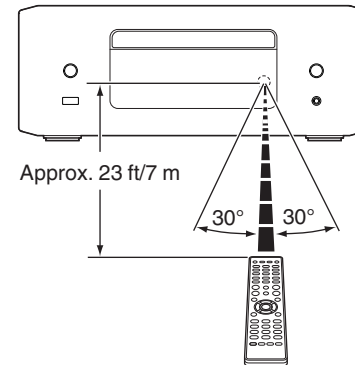

Part names and functions

Front/Top panel

【Top panel】

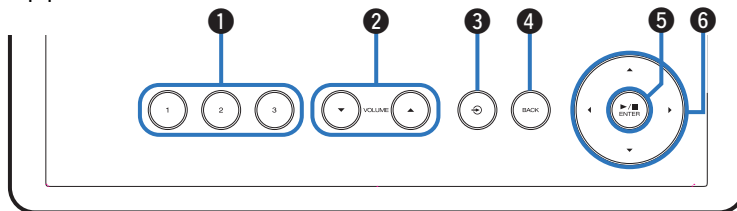

【Front panel】

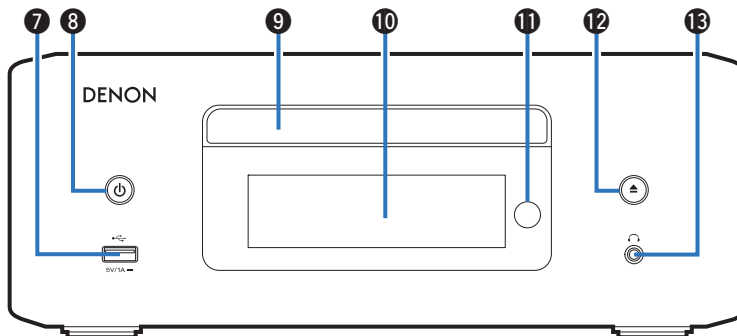

For details, see the next page.



【Top panel】

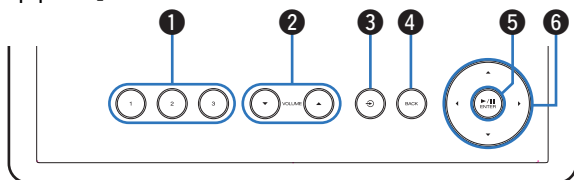

【Front panel】

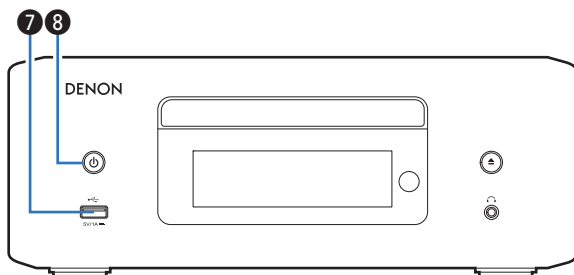
**1 QUICK SELECT keys (1 – 3)**

These call up settings registered to each key, such as input source, volume level and “SDB/Tone” in the setup menu. (☞ p. 80)

2 VOLUME keys (▲▼)

Adjusts the volume.

3 Input source switching key (↻)

This selects the input source.

4 BACK key

Returns to the previous item.

5 Playback/Pause/ENTER key (▶/⏸/ENTER)

Plays back and pauses tracks, and enters the selected content.

6 Cursor keys (▲▼◀▶)

These select items.

7 USB port (🔌)

This is used to connect USB storages (such as USB flash drives). (☞ p. 38)

8 Power (🔌) button

This turns the power on/off (standby). (☞ p. 31)

Power indicator

This is lit as follows according to the power status:

- White: Power on
- Off: Standby

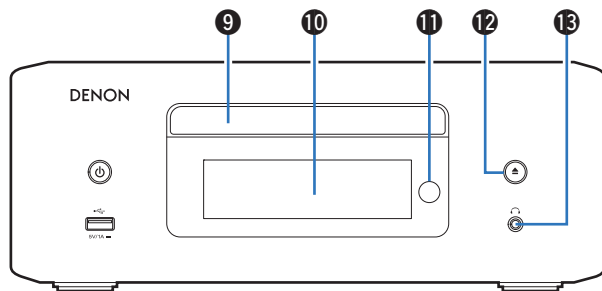

【Front panel】

**9 Disc tray**

Used to insert a disc. (👉 p. 129)

10 Display

This displays various pieces of information.

11 Remote control sensor

This receives signals from the remote control unit. (👉 p. 8)

12 Disc tray open/close button (▲)

Opens and closes the disc tray. (👉 p. 59)

13 Headphones jack (👂)

Used to connect headphones.

When the headphones are plugged into this jack, audio will no longer be output from the speaker terminals and AUDIO OUT connectors (including the SUBWOOFER connector).

NOTE

- To prevent hearing loss, do not raise the volume level excessively when using headphones.



Rear panel

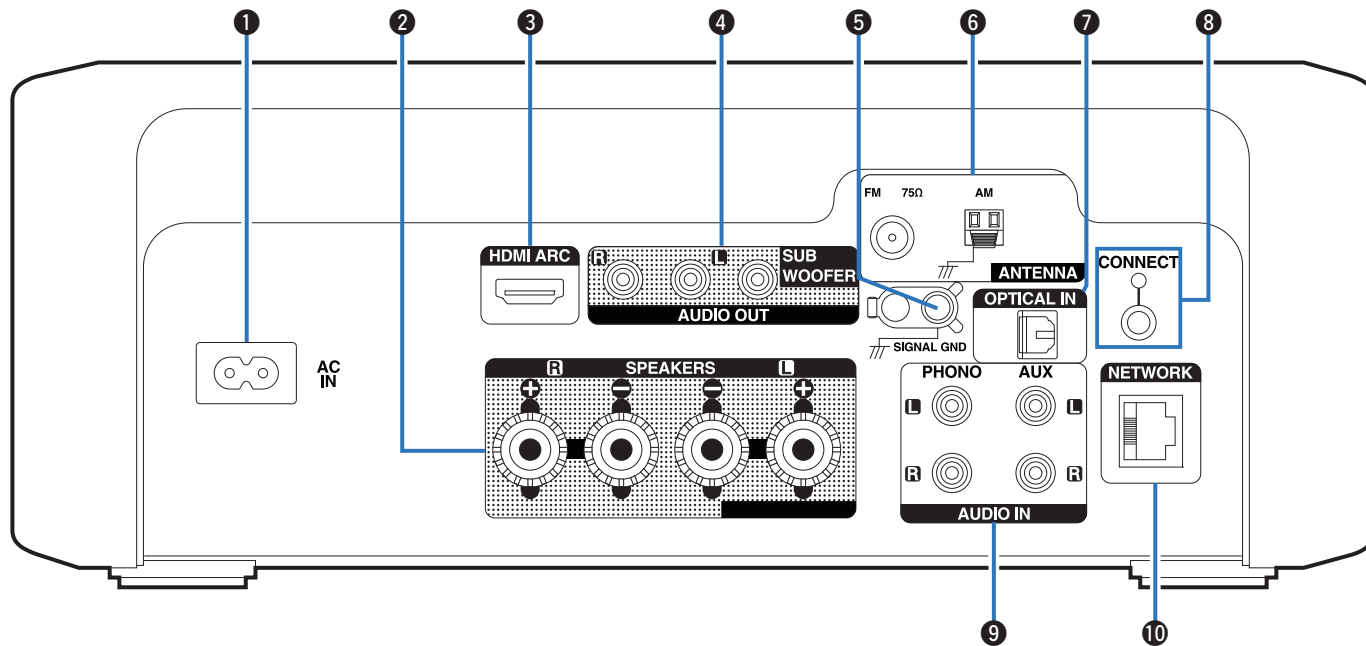

For details, see the next page.

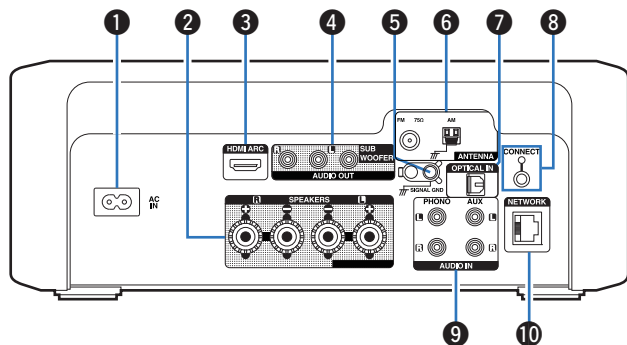

**1 AC inlet (AC IN)**

Used to connect the power cord. (☞ p. 29)

2 Speaker terminals (SPEAKERS)

Used to connect speakers. (☞ p. 19)

3 HDMI connector (HDMI ARC)

Used to connect an ARC function-compatible TV. (☞ p. 22)

4 AUDIO OUT connectors

Used to connect a subwoofer or powered speakers.

- “Connecting the subwoofer” (☞ p. 20)
- “Connecting powered speakers” (☞ p. 21)

5 SIGNAL GND terminal

Used to connect a ground wire for the turntable. (☞ p. 23)

6 Antenna terminals (ANTENNA)

Used to connect FM room antennas and AM loop antennas. (☞ p. 25)

7 OPTICAL IN connector

Connecting to a device with optical digital audio output connector. (☞ p. 22)

8 CONNECT button/light

Used for Wi-Fi setup. (☞ p. 99)

9 AUDIO IN connectors

Connecting to a device with analog audio output connectors. (☞ p. 23)

10 NETWORK connector

Used to connect to a LAN cable when connecting to a wired LAN network. (☞ p. 27)



Remote control unit

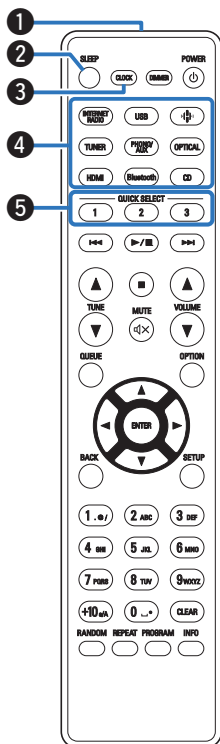

1 Remote control signal transmitter

This transmits signals from the remote control unit. (☞ p. 8)

2 SLEEP button

This sets the sleep timer. (☞ p. 79)

3 CLOCK button

The current time appear on the unit. (☞ p. 79)

4 Input source select buttons

These select the input source. (☞ p. 32)

5 QUICK SELECT buttons (1 – 3)

These call up settings registered to each button, such as input source, volume level and “SDB/Tone” in the setup menu. (☞ p. 80)



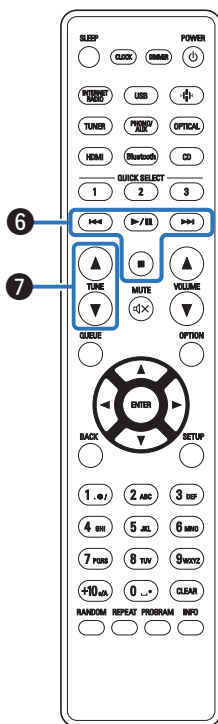

6 System buttons

These perform playback related operations.

- Play/Pause button (▶/⏸)
Press this button to pause during playback. If pressed while paused or stopped, resumes playback from the last track played.
- Forward-skip button (▶▶)
Press this button during playback to play the next track.
Press this button during tuner playback to select stations registered to the preset list. (👉 p. 67)
- Reverse-skip button (◀◀)
Press this button during playback to restart the current track or play the previous track.
Press this button during tuner playback to select stations registered to the preset list. (👉 p. 67)
- Stop button (■)
Press this button to stop during playback.



- Depending on the input source and online service, the operation cannot be performed.

7 TUNE buttons (▲▼)

These operate the tuner. (👉 p. 65)



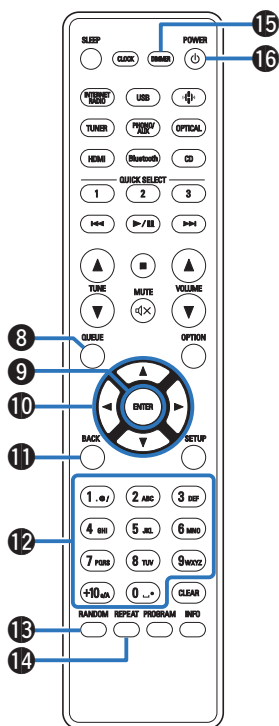

8 QUEUE button

This displays the queue.

- “Listening to Internet Radio” (☞ p. 33)
- “Playing back files stored on PC or NAS” (☞ p. 35)
- “Playing a USB flash drive” (☞ p. 38)

9 ENTER button

This determines the selection.

10 Cursor buttons (Δ▽◀▶)

These select items.

11 BACK button

Returns to the previous item.

12 Number/letter buttons (0 – 9, +10)

These enter letters or numbers into the unit. (☞ p. 84)

13 RANDOM button

Switches the random playback.

14 REPEAT button

Switches the repeat playback.

15 DIMMER button

Adjust the display brightness of this unit. (☞ p. 78)

16 Power (POWER ⏻) button

This turns the power on/off (standby). (☞ p. 31)



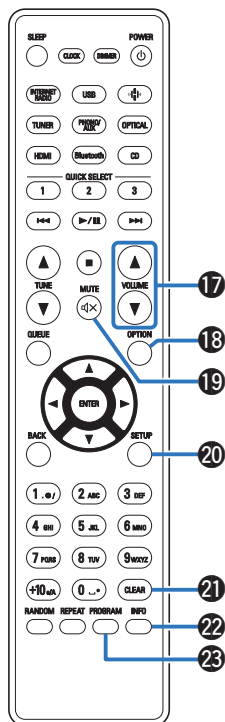

17 VOLUME buttons (▲▼)

Adjusts the volume. (👉 p. 32)

18 OPTION button

This displays the option menu on the display.



- An option menu is not displayed for some input sources.

19 MUTE button (⊘)

This mutes the output audio. (👉 p. 32)

20 SETUP button

The setup menu is displayed on the display. (👉 p. 82)

21 CLEAR button

This cancels the settings.

22 Information button (INFO)

This switches the track information shown in the display during playback.

23 PROGRAM button

- This sets program playback. (👉 p. 61)
- This switches the playback range on a data CD. (👉 p. 64)



■ Contents







Connecting speakers	19
Connecting a digital device	22
Connecting an analog device	23
Connecting a USB flash drive to the USB port	24
Connecting an FM/AM antenna	25
Connecting to a home network (LAN)	27
Connecting the power cord	29

NOTE

- Do not plug in the power cord until all connections have been completed.
- Do not bundle power cords with connection cables. Doing so can result in humming or noise.

■ Cables used for connections

Provide necessary cables according to the devices you want to connect.

Speaker cable (not included)	
Subwoofer cable (not included)	
HDMI cable (included)	
Optical cable (not included)	
Audio cable (not included)	
LAN cable (not included)	



Connecting speakers

NOTE

- Disconnect this unit's power plug from the power outlet before connecting the speakers. Also, turn off the subwoofer.
- Connect so that the speaker cable core wires do not protrude from the speaker terminal. The protection circuit may be activated if the core wires touch the rear panel or if the + and - sides touch each other. "Protection circuit" (☞ p. 138)
- Never touch the speaker terminals while the power cord is connected. Doing so could result in electric shock.
- Use speakers with an impedance of 4 – 16 Ω /ohms.

Connecting the speaker cables

Connect the speaker cable with a rubber tube (red) to the + speaker terminal (red), and the other cable to the - speaker terminal (black).

- 1** Peel off about 3/8 inch (10 mm) of sheathing from the tip of the speaker cable, then either twist the core wire tightly or terminate it.



- 2** Turn the speaker terminal counterclockwise to loosen it.



- 3** Insert the speaker cable's core wire to all the way into the speaker terminal.

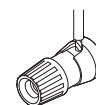

- 4** Turn the speaker terminal clockwise to tighten it.

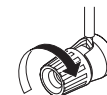

Connecting speakers

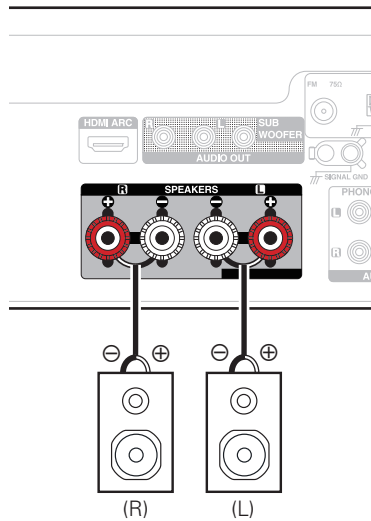

- We recommend using this unit with the SC-N10 speakers from the same series (not included).

Connecting the subwoofer

Use a subwoofer cable to connect the subwoofer.

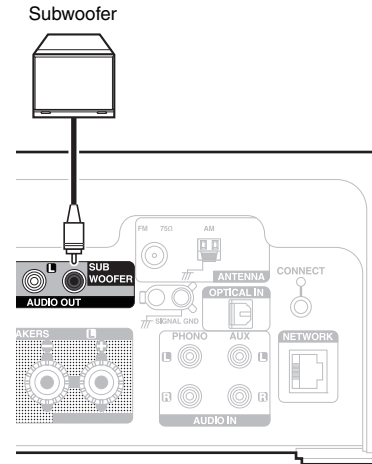

Connecting powered speakers

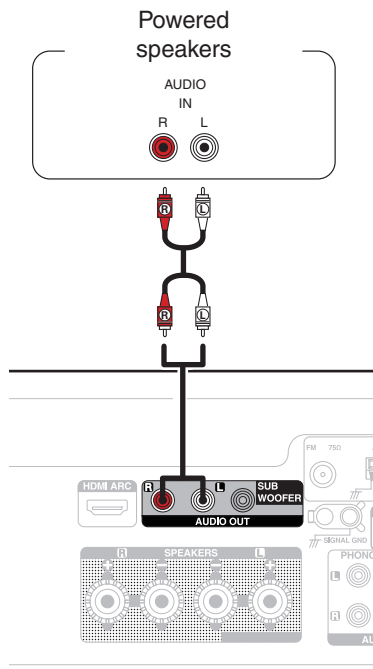

- You can adjust the analog audio output level using the VOLUME ▲▼ buttons. The analog audio output volume is linked to the speaker volume.
- When connecting powered speakers to this unit, see the owner's manual of your powered speakers for details.



Connecting a digital device

Connect this unit to a device with digital output connectors, such as a TV.

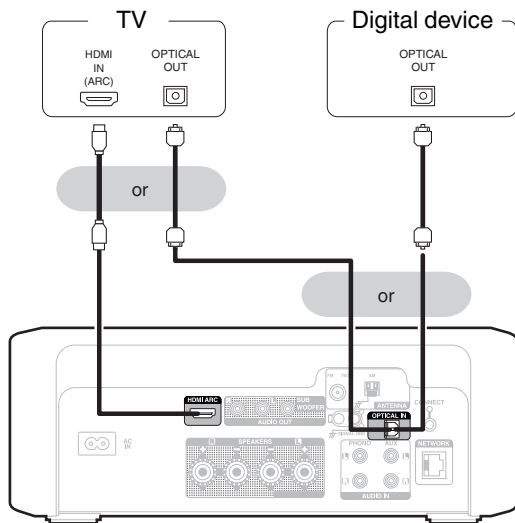

- When connecting a TV to this unit, turn off the audio output of the TV's internal speakers. See the owner's manual of your TV for details.
- When connecting the HDMI ARC terminal of this unit to your TV, connect it to the HDMI input terminal of your TV that supports the ARC function.
- When connecting to a TV that does not support the ARC function, use an Optical connection to play the TV audio.

NOTE

- Only the PCM 2-channel setting can be used to play sound from a TV via the HDMI ARC function and Optical connection. Set "PCM 2ch" as the audio format in the TV settings.
- Linear PCM signals with a sampling frequency of 32 kHz, 44.1 kHz, 48 kHz, 88.2 kHz, 96 kHz, 176.4 kHz, or 192 kHz can be input into this unit.
- Do not input non-PCM signals, such as Dolby Digital, DTS and AAC. This causes noise and could damage the speakers.

■ Specifications of supported audio formats

See "Digital input" (📖 p. 131).



Connecting an analog device

You can connect this unit to various devices with analog audio output. This unit is compatible with turntables equipped with a moving magnet (MM) phono cartridge. When you connect this unit to a turntable with a low output moving coil (MC) cartridge, use a commercially available MC head amp or a step-up transformer.

If you set this unit's input source to "PHONO" and accidentally increase the volume without connecting a turntable, you may hear a humming noise from the speakers.

NOTE

- The earth terminal (SIGNAL GND) of this unit is not for safety grounding purposes. If this terminal is connected when there is a lot of noise, the noise can be reduced. Note that depending on the turntable, connecting the ground line may have the reverse effect of increasing noise. In this case, it is not necessary to connect the ground line.

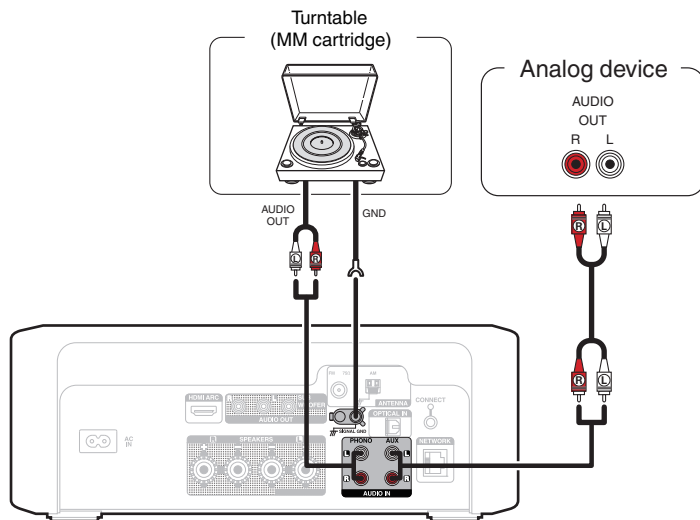

Connecting a USB flash drive to the USB port

For operating instructions see “Playing a USB flash drive” (🔗 p. 38).

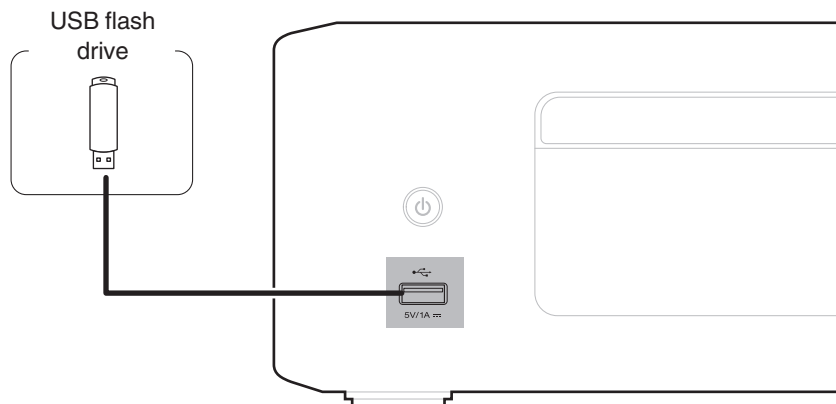

- Denon does not guarantee that all USB flash drives will operate or receive power. When using a portable USB hard disk drive (HDD) which came with an AC adapter, use that device's included AC adapter.

NOTE

- USB flash drives will not work via a USB hub.
- It is not possible to use this unit by connecting the unit's USB port to a PC via a USB cable.
- Do not use an extension cable when connecting a USB flash drive. This may cause radio interference with other devices.



Connecting an FM/AM antenna

After connecting the antenna and receiving a broadcast signal, fix the antenna with tape in a position where the noise level becomes minimal. “Listening to FM/AM broadcasts” (🔧 p. 65)

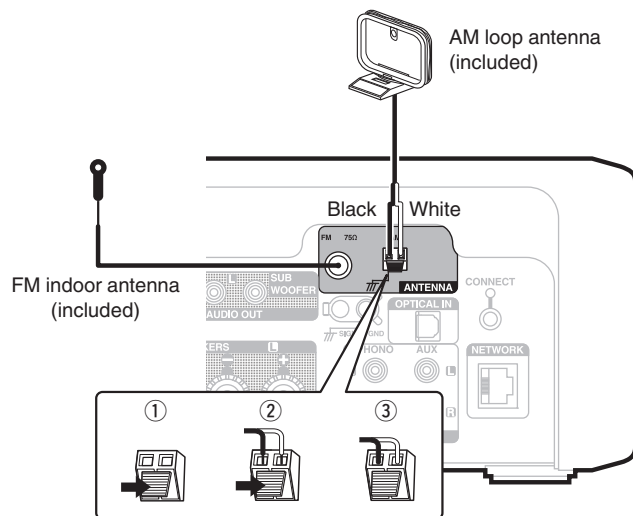

- If you are unable to receive a good broadcast signal, we recommend installing an outdoor antenna. For details, inquire at the retail store where you purchased the unit.

NOTE

- Make sure the AM loop antenna lead terminals do not touch metal parts of the panel.



■ Using the AM loop antenna

Suspending on a wall

Suspend directly on a wall without assembling.

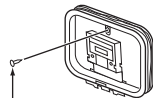

Nail, tack, etc.

Standing alone

Use the procedure shown above to assemble.

When assembling, refer to "AM loop antenna assembly".

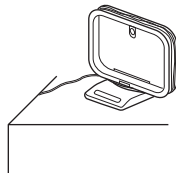

■ AM loop antenna assembly

- 1 Put the stand section through the bottom of the loop antenna from the rear and bend it forward.
- 2 Insert the projecting part into the square hole in the stand.

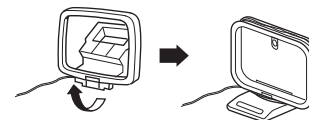
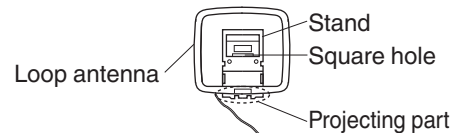

Connecting to a home network (LAN)

This unit can connect to a network using a wired LAN or wireless LAN. You can connect this unit to your home network (LAN) to enable various types of playback and operations as described below.

- Playback of network audio such as Internet Radio and from your media server(s)
- Playback of streaming music services
- Using the Apple AirPlay function
- Operation on this unit via the network
- Operation with the HEOS wireless multi-room sound system
- Firmware Update

For connections to the Internet, contact an ISP (Internet Service Provider) or a computer shop.



- When  is displayed on the display of this unit, this unit is not connected to a network.

Wired LAN

To make connections via wired LAN, use a LAN cable to connect the router to this unit as shown in the figure below.

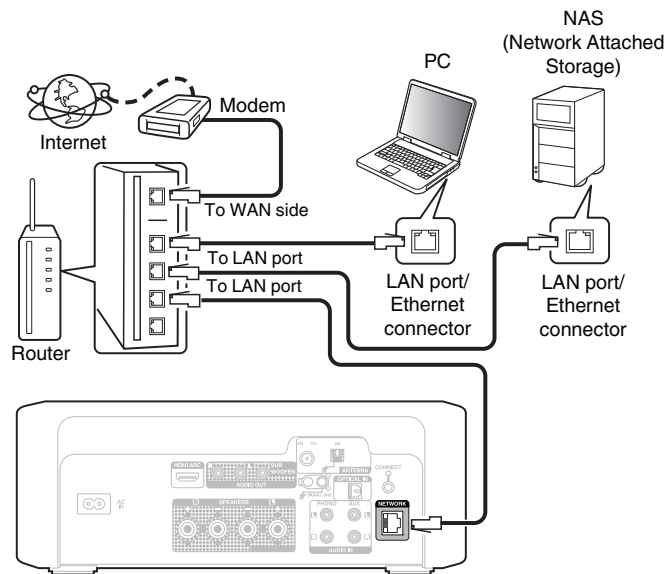

Wireless LAN

To connect to a wireless LAN router, download the HEOS app to your smartphone, and set up this unit. (☞ p. 48)

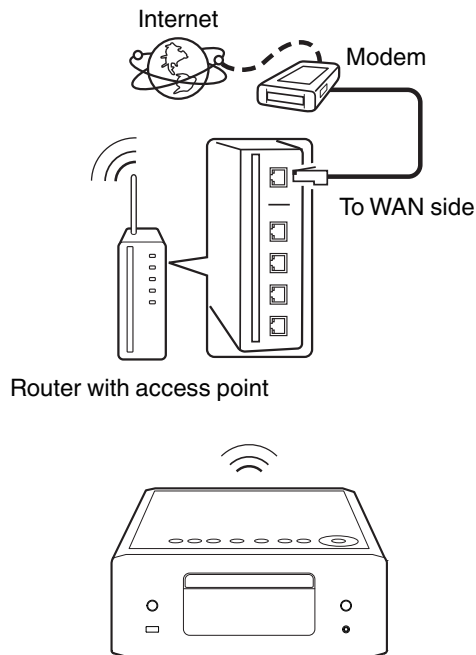

- When using this unit, we recommend you use a router equipped with the following functions:
 - Built-in DHCP server
This function automatically assigns IP addresses on the LAN.
 - Built-in 100BASE-TX switch
When connecting multiple devices, we recommend a switching hub with a speed of 100 Mbps or greater.
- Only use a shielded STP or ScTP LAN cable (readily available at electronics stores). (CAT-5 or greater recommended)
- The normal shielded-type LAN cable is recommended. If a flat-type cable or unshielded-type cable is used, other devices could be affected by noise.

NOTE

- The types of routers that can be used depend on the ISP. Contact your ISP or a computer shop for details.
- This unit is not compatible with PPPoE. A PPPoE compatible router is required if your contracted line is not set using PPPoE.
- Do not connect a NETWORK connector directly to the LAN port/ Ethernet connector on your computer.
- Various online services may be discontinued without prior notice.



Connecting the power cord

After completing all the connections, insert the power plug into the power outlet.

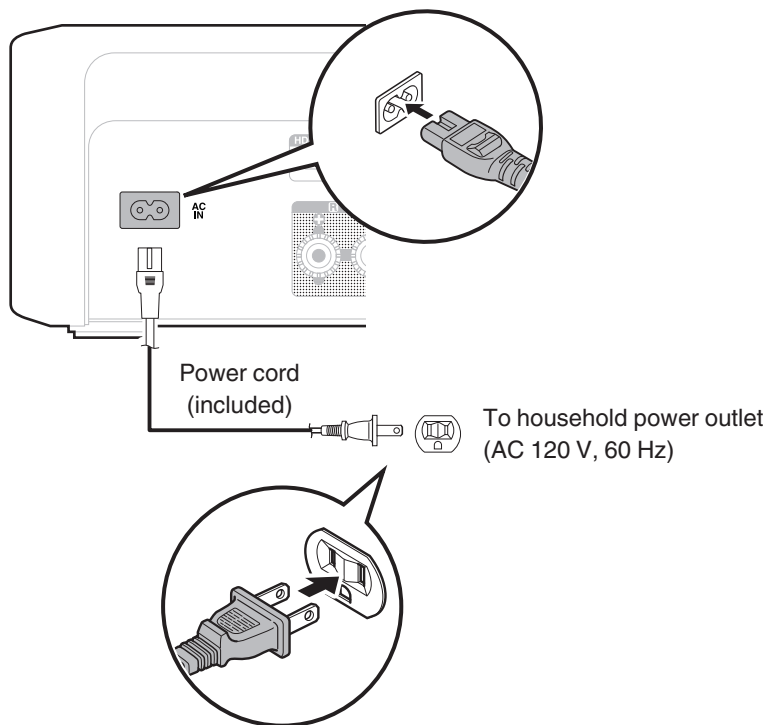

■ Contents

Basic operation

Turning the power on	31
Switching the power to standby	31
Selecting the input source	32
Adjusting the volume	32
Turning off the sound temporarily (Muting)	32

Playback network audio/service

Listening to Internet Radio	33
Playing back files stored on PC or NAS	35
Getting the HEOS app	48
AirPlay function	72
Spotify Connect function	75

Playback a device

Playing a USB flash drive	38
Listening to music on a Bluetooth device	41
Listening to audio on Bluetooth headphones	45
Playing CDs	59
Playing DATA CDs	62
Listening to FM/AM broadcasts	65
Playing digital input	69
Playing analog input	71

Convenience functions

Playing back HEOS Favorites	77
Adding to HEOS Favorites	77
Deleting a HEOS Favorites	78
Switching the display's brightness	78
Using the sleep timer	79
Checking the current time	79
Quick select function	80



Basic operation

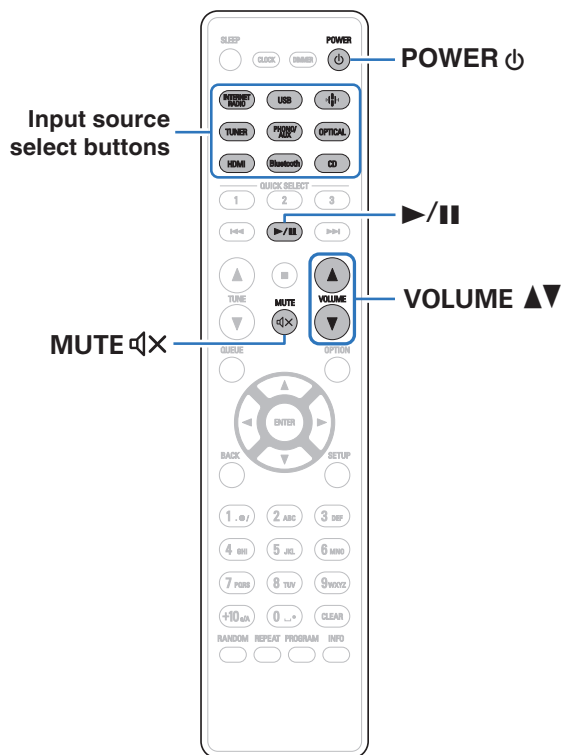

Turning the power on

- 1 Press **POWER** ϕ to turn on power to the unit.
The power indicator lights in white.



- You can also press ϕ on the main unit to turn on power from standby mode.
- You can also press **▶/||** to turn on power from standby mode.

Switching the power to standby

- 1 Press **POWER** ϕ .
The unit switches to standby mode.



- You can also switch the power to standby by pressing ϕ on the main unit.

NOTE

- Power continues to be supplied to some of the circuitry even when the power is in the standby mode. When leaving home for long periods of time or when going on vacation, unplug the power cord from the power outlet.



Selecting the input source

- 1 **Press the input source select button to be played back.**
The selected input source appears on the display.



- This unit switches between FM and AM each time TUNER is pressed.
- You can also select the input source by touching  on the main unit.

Adjusting the volume

- 1 **Use VOLUME ▲▼ to adjust the volume.**
The volume level appears on the display.



- You can also adjust the volume by touching VOLUME ▲▼ on the main unit.

Turning off the sound temporarily (Muting)

- 1 **Press MUTE .**
“Mute” is displayed on the display.



- To cancel mute, either adjust the sound volume or press MUTE  again.



Listening to Internet Radio

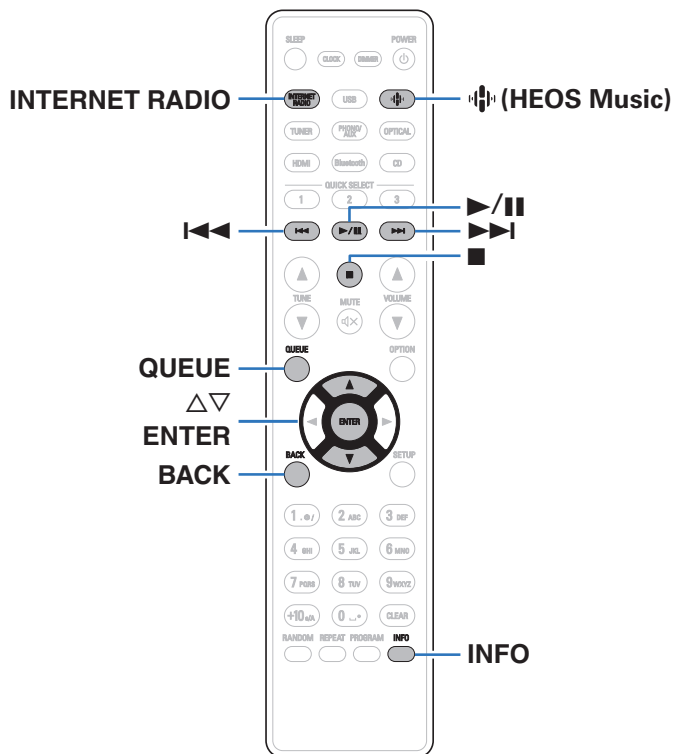

- Internet Radio refers to radio broadcasts distributed over the Internet. Internet Radio stations from around the world can be received.
- The Internet Radio station list on this unit the database service provided by TuneIn Radio service.
- The audio format types and specifications supported by this unit for playback are as follows.
See “Playing back Internet Radio” (p. 133) for details.

- WMA
- MP3
- MPEG-4 AAC





Listening to Internet Radio

1 Press INTERNET RADIO.

- You can also press  (HEOS Music). Use Δ / ∇ to select "Internet Radio", then press ENTER.

2 Select the station you want to play.

Operation buttons	Function
 *	Playback / Pause
	Stop
 *	Skip to previous track / Skip to next track
Δ ∇	Select the item
ENTER	Enter the selected item / Playback
BACK	Moving up a level in the hierarchy
INFO	Switching the song name - artist name, radio station name and file format
QUEUE	This displays the queue

* Enabled when playing Podcasts.



- Any characters that cannot be displayed are replaced with "." (period).

NOTE

- The radio station database service may be suspended or be otherwise unavailable without notice.



Playing back files stored on PC or NAS

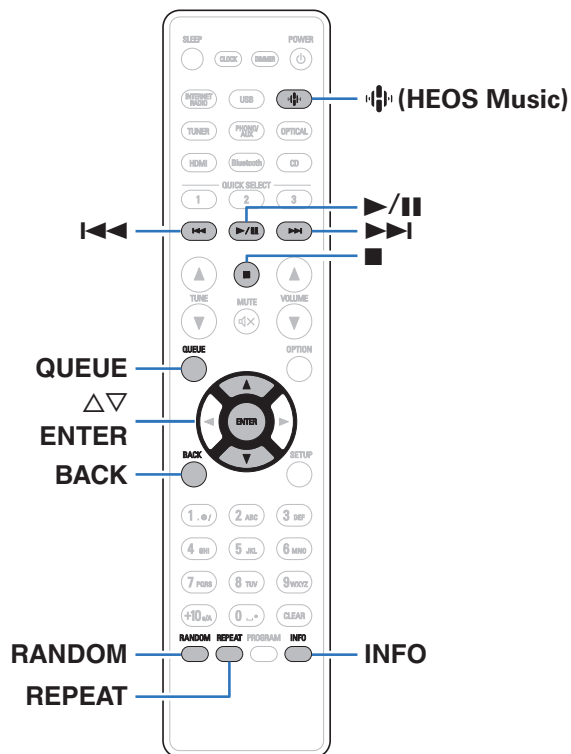

- This unit can play back music files and playlists (m3u, wpl) from DLNA compatible servers including PCs and NAS devices on your network.
- The audio format types and specifications supported by this unit for playback are as follows.

See “Playing back files stored on a PC and NAS” (p. 132) for details.

- WMA
- MP3
- WAV
- MPEG-4 AAC
- FLAC
- Apple Lossless
- DSD



Playing back files stored on PC or NAS

Use this procedure to play music files or playlists stored on DLNA files servers on your local network.

1 Press (HEOS Music).

If a playback history is present, the last Internet radio station or song played is played back. Pressing  (HEOS Music) again displays the HEOS Music top menu.

2 Use cursor to select “Music Servers”, then press ENTER.

3 Select the name of your networked PC or NAS (Network Attached Storage) server.

4 Browse the music on your PC/NAS and select something to play.



- When you select something to play you will be asked how you want to queue up your music.

Play Now:	Inserts the item into the queue after the currently playing track and plays the selected item immediately.
Play Now & Replace Queue:	Clears the queue and plays the selected item immediately.
Play Next:	Inserts the item into the queue after the currently playing track and plays it when the currently playing track ends.
Add to End of Queue:	Adds the item to the end of the queue.



5 Use Δ / ∇ to select the “Play Now” or “Play Now & Replace Queue”, then press ENTER.

Playback starts.

Operation buttons	Function
\blacktriangleright /	Playback / Pause
■	Stop
$\blacktriangleleft\blacktriangleleft\blacktriangleright\blacktriangleright$	Skip to previous track / Skip to next track
Δ ∇	Select the item
ENTER	Enter the selected item
BACK	Moving up a level in the hierarchy
REPEAT	Repeat playback <ul style="list-style-type: none"> Switching between Single-track repeat and All-track repeat
RANDOM	Random playback
INFO	Switching the song name - artist name, album name and file format
QUEUE	This displays the queue

NOTE

- When playing back music files with your PC or NAS connected through wireless LAN, audio may be interrupted depending on your wireless LAN environment. In this case, connect using a wired LAN.
- The order in which the tracks/files are displayed depends on the server specifications. If the tracks/files are not displayed in alphabetical order due to the server specifications, searching by the first letter may not work properly.



Playing a USB flash drive

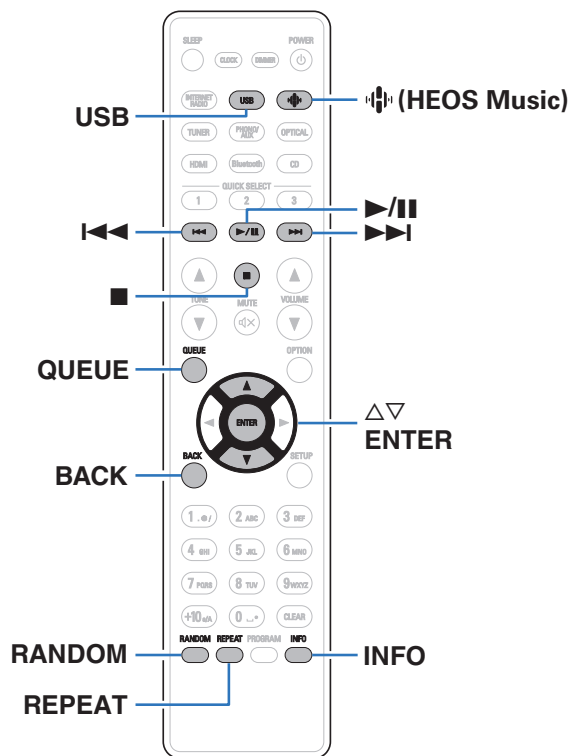

- Playing back music files stored on a USB flash drive.
- Only USB flash drives conforming to mass storage class standards can be played on this unit.
- This unit is compatible with USB flash drives in “FAT32” or “NTFS” format.
- The audio format types and specifications supported by this unit for playback are as follows.
See “Playing back a USB flash drives” (👉 p. 127) for details.

- WMA
- MP3
- WAV
- MPEG-4 AAC
- FLAC
- Apple Lossless
- DSD



Playing files stored on USB flash drives

- 1 Insert the USB flash drive into the USB port.
- 2 Press **USB** to switch the input source to “USB Music”.
 - You can also press **HEOS Music**. Use Δ / ∇ to select “USB Music”, then press **ENTER**.
- 3 Select the name of this unit.

- 4 Browse the music on your USB flash drive and select something to play.



- When you select something to play you will be asked how you want to queue up your music.

Play Now:	Inserts the item into the queue after the currently playing track and plays the selected item immediately.
Play Now & Replace Queue:	Clears the queue and plays the selected item immediately.
Play Next:	Inserts the item into the queue after the currently playing track and plays it when the currently playing track ends.
Add to End of Queue:	Adds the item to the end of the queue.

- 5 Use Δ / ∇ to select the “Play Now” or “Play Now & Replace Queue”, then press **ENTER**.

Playback starts.



Operation buttons	Function
▶/	Playback / Pause
■	Stop
◀◀▶▶	Skip to previous track / Skip to next track
△ ▽	Select the item
ENTER	Enter the selected item / Playback
BACK	Moving up a level in the hierarchy
REPEAT	Repeat playback <ul style="list-style-type: none"> Switching between Single-track repeat and All-track repeat
RANDOM	Random playback
INFO	Switching the song name - artist name, album name and file format
QUEUE	This displays the queue

NOTE

- Note that Denon will accept no responsibility whatsoever for any problems arising with the data on a USB flash drive when using this unit in conjunction with the USB flash drive.
- When a USB flash drive is connected to this unit, the unit loads all of the files on the USB flash drive. Loading may take a while if the USB flash drive contains a large number of folders and/or files.



Listening to music on a Bluetooth device

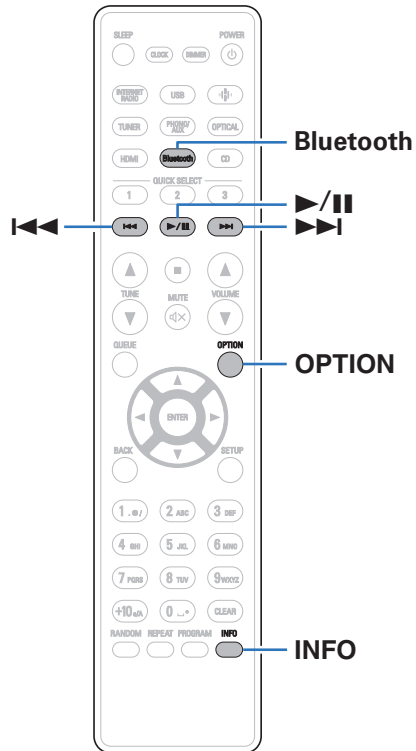

Music files stored on Bluetooth devices such as smartphones, digital music players, etc. can be enjoyed on this unit by pairing and connecting this unit with the Bluetooth device.

Communication is possible up to a range of about 98.4 ft/30 m.

NOTE

- To play back music from a Bluetooth device, the Bluetooth device needs to support the A2DP profile.



Listening to music on a Bluetooth device

In order to enjoy music from a Bluetooth device on this unit, the Bluetooth device must first be paired with this unit.

Once the Bluetooth device has been paired, it does not need to be paired again.

1 Press Bluetooth.

When playing content via Bluetooth on this unit for the first time, the unit will go into the pairing mode automatically.



2 Activate the Bluetooth settings on your Bluetooth device.

3 Select this unit when its name appears in the list of devices displayed on the screen of the Bluetooth device.

Perform the connection with the Bluetooth device close to the unit (about 3.3 ft/1 m).

4 Play music using any app on your Bluetooth device.

- The Bluetooth device can also be operated with the remote control of this unit.
- The next time the Bluetooth button is pressed on the remote control unit, this unit automatically connects to the last Bluetooth device that was connected.

Operation buttons	Function
	Playback / Pause
	Skip to previous track / Skip to next track
INFO	Switching the song name - artist name, Bluetooth device name and album name.



Pairing with other Bluetooth devices

Pair a Bluetooth device with this unit.

- 1 Activate the Bluetooth settings on your Bluetooth device.**
- 2 Press and hold Bluetooth on the remote control unit for at least 3 seconds.**
This unit will go into the pairing mode.
- 3 Select this unit when its name appears in the list of devices displayed on the screen of the Bluetooth device.**



- This unit can be paired with a maximum of 8 Bluetooth devices. When a 9th Bluetooth device is paired, it will be registered in place of the oldest registered device.
- You can also enter pairing mode by pressing the OPTION button when the Bluetooth playback screen is displayed and selecting "Pairing Mode" from the displayed option menu.

NOTE

- To operate the Bluetooth device with the remote control of this unit, the Bluetooth device needs to support the AVRCP profile.
- The remote control of this unit is not guaranteed to work with all Bluetooth devices.
- Depending on the type of Bluetooth device, this unit outputs audio that is coupled to the volume setting on the Bluetooth device.



Reconnecting to this unit from a Bluetooth device

After pairing is completed, the Bluetooth device can be connected without performing any operations on this unit.

This operation also needs to be performed when switching the Bluetooth device for playback.

- 1 If a Bluetooth device is currently connected, deactivate the Bluetooth setting of that device to disconnect it.**
- 2 Activate the Bluetooth setting of the Bluetooth device to be connected.**
- 3 Select this unit from the Bluetooth device list on your Bluetooth device.**
- 4 Play music using any app on your Bluetooth device.**



- When the power of this unit and the Bluetooth function of this unit are turned on, the input source will be automatically switched to “Bluetooth” if a Bluetooth device is connected.
- When the “Network Control” setting of this unit is set to “On” and a Bluetooth device is connected and is played with the unit in the standby state, the power of the unit will be turned on automatically. (🔗 p. 98)



Listening to audio on Bluetooth headphones

You can listen to the sounds that are played back in this device from Bluetooth headphones.

Output audio from connected speakers and Bluetooth headphones simultaneously, or only using Bluetooth headphones.

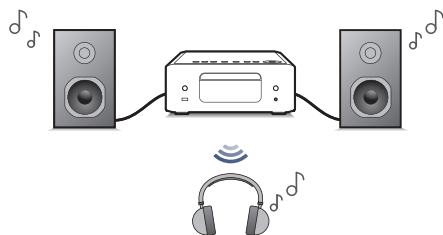

(Output Mode: HP+ Speakers)

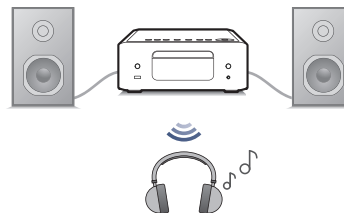

(Output Mode: Headphones)

Listening to audio on Bluetooth headphones

- 1 Set “Headphone” to “On” from the “Network” - “Bluetooth” setting in the setup menu. (☞ p. 97)
- 2 Select “Output Mode”, and set audio output.

HP + Speakers (Default):	Audio is output to Bluetooth headphones and speakers. This simultaneous output is suitable for family movie night and other group activities.
Headphones:	Audio is output to Bluetooth headphones only. This is suitable for listening to music or watching movies by yourself at night when you need to keep quiet.
- 3 Enter pairing mode on the Bluetooth headphones you want to connect to this unit.
- 4 Select “Devices” and select the name of the Bluetooth headphones from the device list.
- 5 Adjust the volume of connected Bluetooth headphones after the connection is completed.



- A2DP profile-compatible Bluetooth speakers can be connected following the same steps used to connect Bluetooth headphones.

NOTE

- Bluetooth headphones volume cannot be adjusted from this unit. Adjust volume of your Bluetooth headphones.
- The settings for “SDB/Tone” in the setup menu specified on this unit are not reflected to/in the sound output of Bluetooth headphones.
- Audio may be delayed when sent over Bluetooth.
- Bluetooth headphones cannot be connected when use a Bluetooth input source. Furthermore, selecting a Bluetooth input source will terminate the connection between this unit and Bluetooth headphones.
- Bluetooth headphones cannot be connected when this unit is grouped in the HEOS app.
- Bluetooth headphones cannot be connected if a HEOS built-in device is playing an input source from this unit.

CAUTION: Using Bluetooth headphones without a volume adjustment function

- In order to avoid hearing loss, do not connect Bluetooth headphones that lack volume adjustment functionality.
- Bluetooth headphone volume may be unexpectedly loud when this unit connects to Bluetooth headphones.
- Bluetooth headphone volume cannot be adjusted from this unit.



Reconnecting to a Bluetooth headphones

Follow any of the steps below to reconnect the most recently used Bluetooth headphones:

- Reconnect to this unit with Bluetooth headphone's reconnect function.
- If "Output Mode" is set to "HP+ Speakers", this unit will automatically connect to the most recently used Bluetooth headphones when power is turned on.
- Select the device you wish to connect from the "Devices" under "Bluetooth" in the setup menu. (👉 p. 97)

Disconnecting Bluetooth headphones

Complete any of the following steps to disconnect your Bluetooth headphones:

- Turn off your Bluetooth headphones.
- In the setup menu, go to "Network" - "Bluetooth", and set "Headphone" to "Off". (👉 p. 97)



Getting the HEOS app

You can use many online music streaming services from the HEOS app. Depending upon your geographical location, there are several options to choose from.

Download the HEOS app for iOS or Android by searching App Store, Google Play store or Amazon Appstore for “HEOS”.



- Specifications of the HEOS app may be changed without prior notice for improvement purposes.



Setting up the HEOS app for the first time with a HEOS built-in device

Once you have placed this unit in your listening room and have downloaded the HEOS app, you are ready to configure this unit for music playback. This involves following a few simple steps to get this unit connected to your existing home network:



- DO NOT connect the Ethernet cable if you are connecting this unit to a wireless network. If you are connecting this unit to a wired network, use an Ethernet cable (not included) to connect this unit to your network or router.

1 Make sure your mobile device is connected to your wireless network (the network you want to connect to this device).

You can check this in the “Settings” - “Wi-Fi” menu of your iOS or Android device.



- Activate the Bluetooth setting on your mobile device.
- If your wireless network is secure, make sure you know the password to join your network.

2 Launch the HEOS app on your mobile device.



3 Tap the “Setup Now” button at the top of the screen.

4 Follow the instructions to add this unit to your wireless network and to select an input on this unit.



Adding the registration of HEOS built-in devices in the HEOS app

The HEOS system is a true multiroom audio system that automatically synchronizes audio playback between multiple HEOS built-in devices so that the audio coming from different rooms is perfectly in sync and always sounds amazing! You can easily add up to 32 HEOS built-in devices to your HEOS system.

■ Adding wired HEOS built-in devices

Just connect the HEOS built-in devices to your home network using an Ethernet cable and the HEOS built-in device will appear on your HEOS app as a new room in the Rooms screen. For information about wired LAN connections, refer to “Connecting to a home network (LAN)” (🔗 p. 27).

At your convenience, you can assign a name to the HEOS built-in device to indicate which room you have it placed in.

■ Adding wireless HEOS built-in devices

You can add additional wireless HEOS built-in devices to your HEOS system by selecting “Add Device” from the HEOS app’s settings menu and follow the instructions:

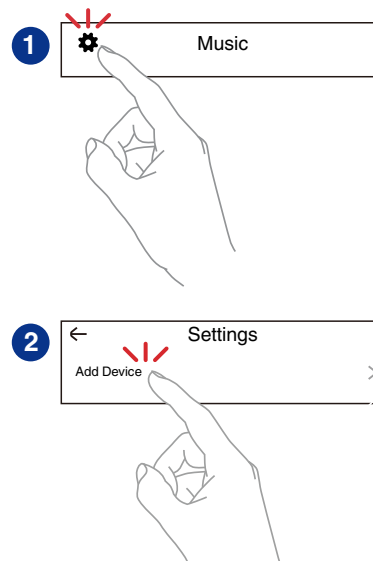

HEOS Account

HEOS Accounts can be registered by tapping “Music” tab - “Settings” icon  in the HEOS app.

Once you create or sign into your HEOS Account, you can use the HEOS Favorites feature to save and recall your favorite streaming radio stations using this unit.

■ What is a HEOS Account?

A HEOS Account is master account or “keychain” for managing all of your HEOS music services with one single username and password.

■ Why do I need a HEOS Account?

With the HEOS Account you just have to enter your music services login names and passwords one time. This allows you to easily and quickly use multiple controller apps on different devices.

You just log into your HEOS Account on any device and you will have access to all of your associated music services, play history and custom playlists, even if you are at a friend's house listening to music on their HEOS system.

■ Signing up for a HEOS Account

You will be instructed to sign up for a HEOS Account the first time you try to access any music service from the main “Music” menu of the HEOS app. Follow the instructions in the HEOS app to complete the operation.



- This unit's HEOS Account setting information is synced with the HEOS app. Change settings and sign out of your account through the HEOS app.

■ Changing your HEOS Account

- 1 Tap the “Music” tab.
- 2 Select the Settings icon  in the upper left corner of the screen.
- 3 Select “HEOS Account”.
- 4 Change your location, change your password, delete your account or sign out of your account.



- This unit automatically syncs when you change your account settings or sign out through the HEOS app. To switch HEOS accounts, play back music from an HEOS app signed in to the account you wish to sync to this unit. The “HEOS Account” switches automatically.



Playing from streaming music services

A music service is an online music company that provides access to vast music collections via free and/or paid subscriptions. Depending upon your geographical location, there are several options to choose from.

NOTE

- The HEOS app and brand is not affiliated with any manufacturer of any mobile device. Availability of music services may vary by region. Not all services may be available at time of purchase. Some services may be added or discontinued from time to time based on decisions of the music service providers or others.

■ Selecting a room/device

- 1 Tap the “Rooms” tab. Select “Denon CEOL” if there are multiple products with HEOS Built-in.



- Tap the Pencil icon  at the top right to switch edit mode. You can change the displayed name.

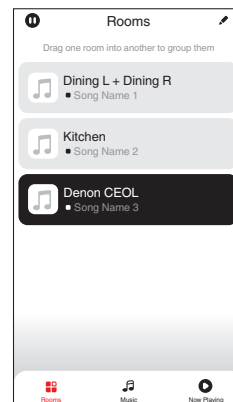

■ Selecting the music track or station from music sources

1 Tap the “Music” tab and select a music source.



- All music services displayed may not be available in your location.

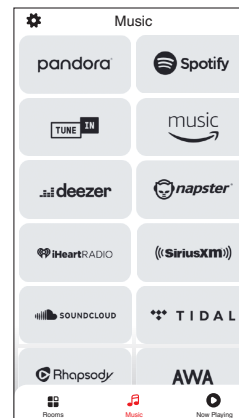

2 Browse the music to play.

After selecting a music track or radio station the app will automatically change to the “Now Playing” screen.



- When you select a music track to play you will be asked how you want to queue up your music.

Play Now:	Inserts the item into the queue after the currently playing track and plays the selected item immediately.
Play Now & Replace Queue:	Clears the queue and plays the selected item immediately.
Play Next:	Inserts the item into the queue after the currently playing track and plays it when the currently playing track ends.
Add to End of Queue:	Adds the item to the end of the queue.



- When you select a radio station the following items are displayed.

Play Now:	Plays the selected item immediately.
Add to HEOS Favorites:	Adds to HEOS Favorites.



- Set “Network Control” of the settings menu to “On” so that when you are playing back from the HEOS app while this device is in standby, this device turns on automatically. (“Network Control” (🔧 p. 98))

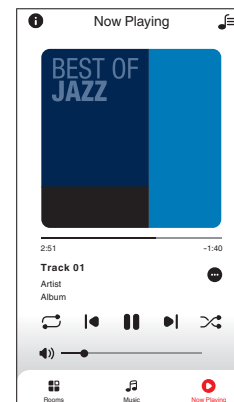
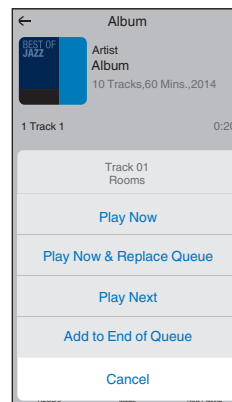

Listening to the same music in multiple rooms

This system is a true multi-room audio system. You can create one or more HEOS groups to automatically synchronize audio playback between multiple products with HEOS Built-in so that the music playing different rooms is perfectly in sync and always sounds amazing! You can easily add up to 32 products to your system in total. You can group up to 16 individual products to have them play the same song fully synchronized.

■ Grouping rooms

- 1** Press and hold your finger on room that is not playing music.
- 2** Drag it into the room that is playing music and lift your finger.
- 3** The two rooms will be grouped together into a single device group and both rooms will be playing the same music in perfect sync.

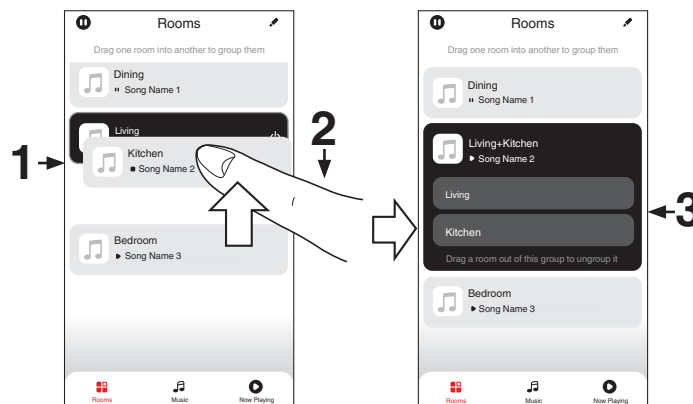

■ Ungrouping rooms

- 1 Press and hold your finger on room that you want to remove from the group.
- 2 Drag it out of the group and lift your finger.

NOTE

- You can not remove the first room that started playing the music before grouping.

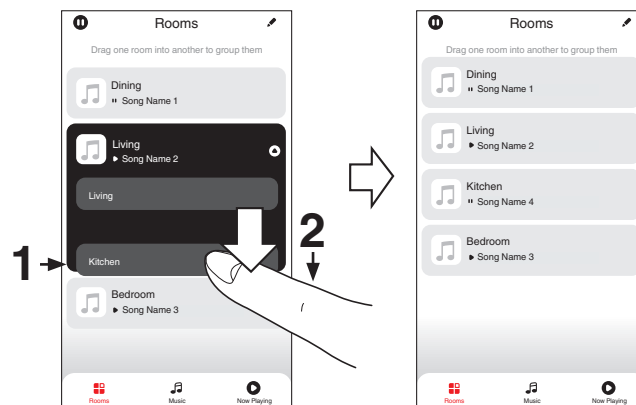

■ Grouping all rooms (party mode)

You can easily group 16 rooms together into Party Mode by using a “pinch” gesture.

- 1** Place two fingers on the screen over the list of rooms.
- 2** Quickly pinch your two fingers together and release.
- 3** All of your rooms will be joined together and begin playing the same music in perfect sync.



■ Ungrouping all rooms

You can easily ungroup all of your rooms and exit Party Mode by using a “spread” gesture.

- 1 Place two fingers close together on the screen over list of rooms.**
- 2 Quickly spread your two fingers apart from each other and release.**
- 3 All of your rooms will be ungrouped.**

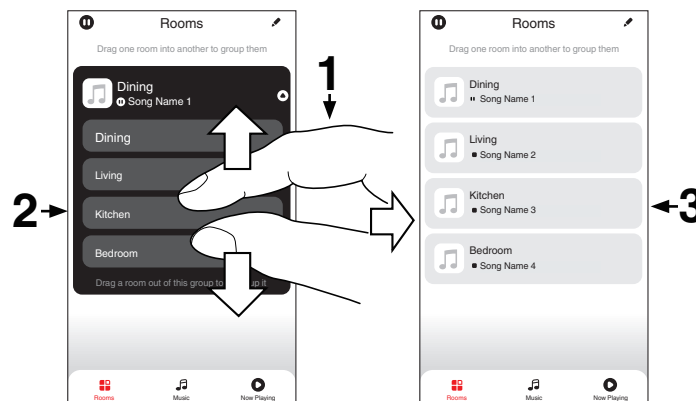

Playing CDs

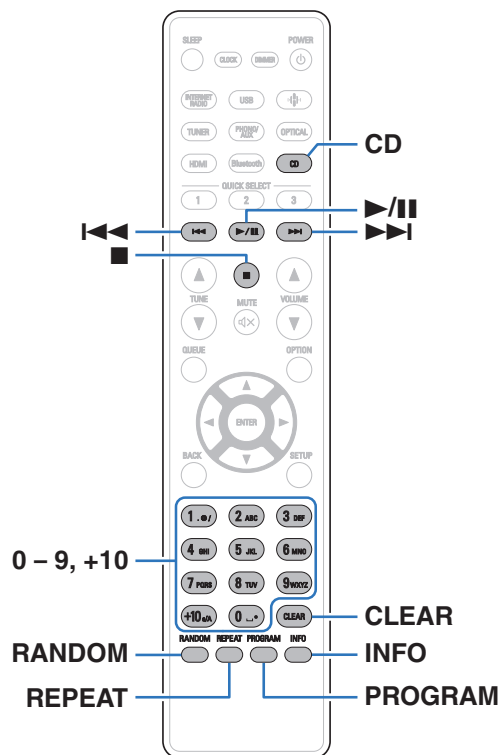

Playing CDs

- 1 Press CD to switch the input source to “CD”.
- 2 Insert a disc. (👉 p. 129)
Playback starts.
 - Press ▲ on the main unit to open/close the disc tray.





- You can set whether to automatically play CDs. (👉 p. 94)

NOTE

- Do not place any foreign objects in the disc tray. Doing so could damage the set.
- Do not push the disc tray in by hand when the power is turned off. Doing so could damage the set.



Operation buttons	Function
	Playback / Pause
	Stop
	Skip to previous track / Skip to next track (Press and hold) Fast-reverse / Fast-forward
0 - 9, +10	Select the track
RANDOM	Random playback
REPEAT	Repeat playback <ul style="list-style-type: none"> Switching between All-track repeat and Single-track repeat.
INFO	Time display switching <ul style="list-style-type: none"> Switching between elapsed time of the current track and remaining time of the current track.

■ Playing a specific track (Direct searching)

1 Use 0 - 9, +10 to select the tracks.

[Example]

Track 4 : Press number 4 to select track 4.

Track 12 : Press numbers +10 and 2 consecutively to select track 12.



Playing tracks in a specific order (Program playback)

Up to 25 tracks can be programmed.

1 In the stop mode, press PROGRAM.

“Program” is displayed on the display.

2 Use 0 – 9, +10 to select the tracks.

[Example]

Track 4 : Press number 4 to select track 4.

Track 12 : Press numbers +10 and 2 consecutively to select track 12.

3 Press ►/II.

Playback starts in the programmed order.



- Press RANDOM while program playback to enter random playback mode. When ►/II is pressed during random playback mode, the programmed tracks are played in random order.
- When REPEAT is pressed during program playback, the tracks are played repeatedly in the programmed order.

NOTE

- The program is cleared when the disc tray is opened or the power is turned off.

■ Checking the order of the programmed tracks

In the stop mode, press ►►I.

The tracks are shown in the programmed order in the display each time ►►I is pressed.

■ Clears the programmed tracks

In the stop mode, press CLEAR.

The last track programmed is cleared each time the button is pressed.



- You can also select a track to be cleared by pressing ►►I.

■ Clearing the all programmed track

In the stop mode, press PROGRAM.



Playing DATA CDs

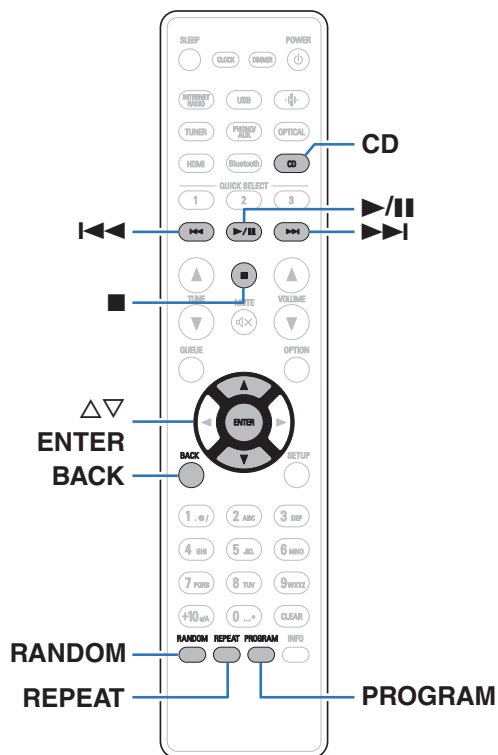

- This section explains how to playback music files that are recorded onto a CD-R or CD-RW.
- There are many music distribution sites on the Internet allowing you to download music files in MP3 or WMA (Windows Media® Audio) format. The music (files) downloaded from such sites can be stored on CD-R or CD-RW discs and played on this unit.
- The audio format types and specifications supported by this unit for playback are as follows. See “Specifications of supported files” (p. 125) for details.
 - **MP3**
 - **WMA**

NOTE

- Copyright-protected files cannot be played.
- Note that depending on the software used for burning and other conditions, some files may not play or display correctly.

“Windows Media” and “Windows” are the trademarks or registered trademarks of Microsoft Corporation in the United States and other countries.



Playing files

- 1 Press **CD** to switch the input source to “CD”.
- 2 Load a **CD-R** or **CD-RW** containing music files into the disc tray. (🔧 p. 129)

Playback starts.

- Press **▲** on the unit to open/close the disc tray.



- You can set whether to automatically play CDs. (🔧 p. 94)

Operation buttons	Function
▶/	Playback / Pause
■	Stop
◀◀▶▶	Skip to previous track / Skip to next track (Press and hold) Fast-reverse / Fast-forward
BACK	Moving up a level in the hierarchy
△▽	Select the item
ENTER	Enter the selected item / Playback
RANDOM	Random playback
REPEAT	Repeat playback <ul style="list-style-type: none"> • Switching between All-track repeat and Single-track repeat.
PROGRAM	Select the playback range
INFO	Switches the display between Title name / Artist name, Title name / Album name and File name.



- To start playing another file during playback of a CD-R/CD-RW, first press **BACK** to display the file tree. Next, use **△▽** to select the file to be played and press **ENTER**.



■ Switching the display

During playback, press INFO.

- Switches the display between Title name / Artist name, Title name / Album name and File name.
- If a file does not support text information or no track information is recorded, the file name is displayed.
- The player can display the following characters:

ABCDEFGHIJKLMNOPQRSTUVWXYZ

abcdefghijklmnopqrstuvwxyz

0123456789

!"#\$%&:;<>?@\[_`!{|}~^'()*+,-./= space

- Any characters that cannot be displayed are replaced with "." (period).
- The folder and file numbers are set automatically when the disc is loaded.

■ Switching the playback range

Press PROGRAM.

- The playback range of a track can be set.

Folder mode:

All the files in the selected folder are played. is displayed on the display at this time.

All mode:

All the files in the disc are played.



Listening to FM/AM broadcasts

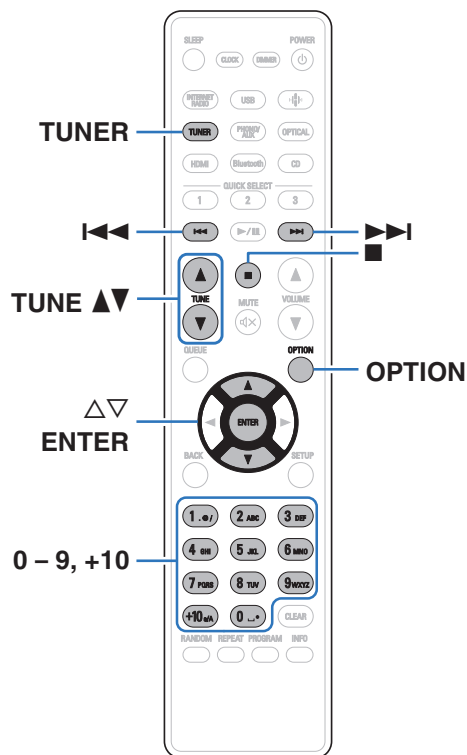

For details about how to connect the antenna, see “Connecting an FM/AM antenna” (👉 p. 25).

Listening to FM/AM broadcasts

1 Press TUNER to select the reception band.

FM: When listening to an FM broadcast.

AM: When listening to an AM broadcast.

2 Use TUNE ▲▼ to select the station you want listen to.

When a station is received, the 📶 indicator lights.

The ST indicator lights up when a stereo broadcast is received.



Changing the reception mode (Tune Mode)

Change the reception mode to FM/AM. If you cannot tune in automatically with "Auto" mode (AUTO), then change the mode to "Manual" mode (No indication) and tune in manually.

- 1 Press OPTION during FM/AM reception.**
An option menu is displayed.
- 2 Use $\Delta\nabla$ to select "Tune Mode" then press ENTER.**
- 3 Use $\Delta\nabla$ to select the desired mode, then press ENTER.**

Auto (AUTO):	Automatically search for and tune to a receivable radio station.
Manual (No indication):	Manually change the frequency one step at a time each time the button is pressed.

Presetting FM/AM stations

Up to 50 stations can be registered in the preset list.

- 1 Press OPTION during reception of the station to be registered.**
An option menu is displayed.
- 2 Use $\Delta\nabla$ to select "Preset Memory", then press ENTER.**
- 3 Use $\Delta\nabla$, select the number to register the station to in the preset list and press ENTER.**
"Added" is displayed and the registration is completed.



Automatically presetting FM stations (Auto Preset)

You can automatically register all FM stations that can be received to the preset list. Up to 50 stations can be registered.

1 Press **OPTION** during FM reception.

An option menu is displayed.

2 Use $\Delta\nabla$ to select “Auto Preset Memory”, then press **ENTER**.

3 Use $\Delta\nabla$ to select “Start”, then press **ENTER**.

The unit starts to tune in to radio stations automatically and preset them.

- When presetting is completed, “Complete!!” is displayed.



- To stop auto tuning, press **■**.
- Broadcast stations whose antenna signals are weak cannot be preset automatically. If you wish to preset such stations, tune them in manually.
- Additional stations cannot be registered to the preset list after 50 stations are registered.
- AM stations cannot be automatically preset.

Listening to stations registered in the preset list

1 Press **OPTION** during reception of a station.

An option menu is displayed.

2 Use $\Delta\nabla$ to select “Preset List”, then press **ENTER**.

3 Use $\Delta\nabla$ and select the radio station that you want to listen to, then press **ENTER**.

4 Use $\Delta\nabla$ to select “Play Now”, then press **ENTER**.



- You can select the station you want to listen to from the preset list by pressing 0-9 and +10.
- You can switch between preset stations by pressing **I◀◀▶▶I**.



Deleting a station from the preset list

- 1 Press OPTION during reception of a station.**
An option menu is displayed.
- 2 Use $\Delta\nabla$ to select “Preset List”, then press ENTER.**
- 3 Use $\Delta\nabla$ to select the station you want to delete, then press ENTER.**
- 4 Use $\Delta\nabla$ to select “Remove from Preset List”, then press ENTER.**
“Removed” is displayed and the deletion is completed.



Playing digital input

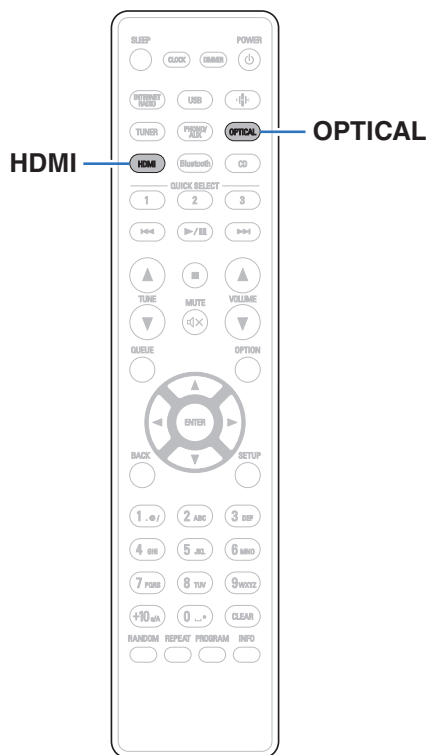

1 Prepare for playback.

Check the connection, then turn on this units. (“Connecting a digital device” (p. 22))

2 Press HDMI or OPTICAL to switch the input source to “HDMI” or “Optical”.

3 Play the component connected to this unit.

- If the sampling frequency cannot be detected, “Signal Unlock” will be displayed.
- “Unsupported” is displayed when audio signals that are not supported by this unit are input.





- When “TV Input” is set in the menu, this unit automatically turns on when the TV connected to the unit is turned on, and the input source switches to “HDMI” or “Optical”. (👉 p. 89)

NOTE

- Do not input non-PCM signals, such as Dolby Digital and DTS. This causes noise and could damage the speakers.

■ Specifications of supported audio formats

See “Digital input” (👉 p. 131).



Playing analog input

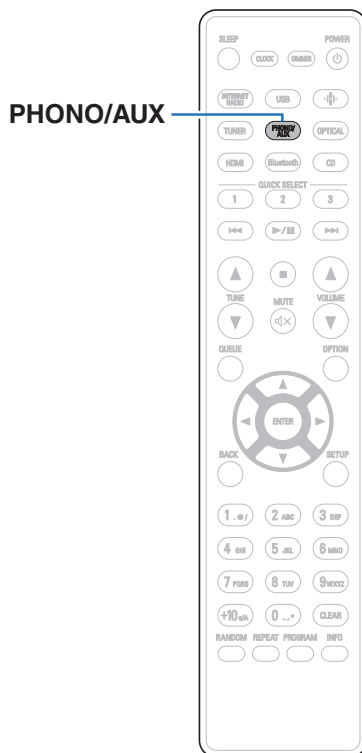

1 Prepare for playback.

Check the connection, then turn on this units. (“Connecting an analog device” (🔗 p. 23))

2 Press PHONO/AUX to switch the input source to “Phono” or “AUX”.

- The input source is switched to “Phono” or “AUX” each time PHONO/AUX is pressed.

3 Play the component connected to this unit.



AirPlay function

Music files stored on your iPhone, iPod touch, iPad, Mac or Windows PC can be played on this unit via the network.



- Input source will be switched to “AirPlay” when AirPlay playback is started.
- You can stop AirPlay playback by choosing other input source.
- The screen may differ depending on the OS and software versions.

This device supports AirPlay 2.

Sync multiple AirPlay 2 compatible devices/speakers for simultaneous playback.

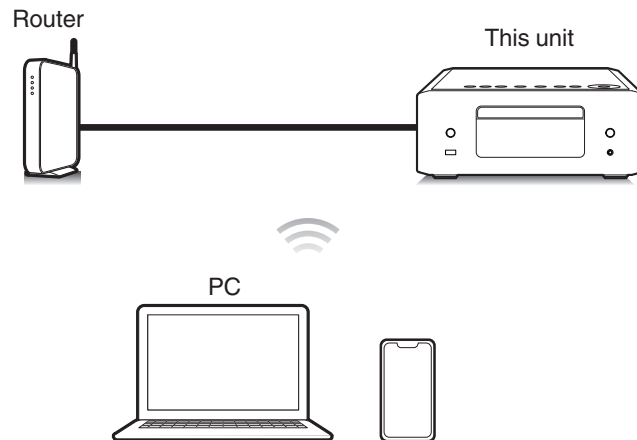

Playing songs from your iPhone, iPod touch, iPad or Mac

You can stream music stored in your “iPhone/iPod touch/iPad/Mac” directly to this unit.

1 Connect your iPhone, iPod touch, iPad or Mac Wi-Fi to the same network as this unit.

- For details, see your device’s manual.

2 Open Apple Music and play music from your iPhone, iPod touch or iPad.

3 Tap or click the AirPlay icon and select this unit.

[Example] iOS 15 or macOS 13

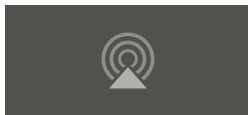

[Example] iOS 10



- You can also use AirPlay to stream music from other applications. Open the Control Center, tap or click the AirPlay icon, then select this unit.
- To use AirPlay, your iOS device must support iOS 10.0.2 or later, or OS X Mountain Lion 10.8 or later.

Playing songs from Windows PC

- 1 Install iTunes 10, or later, on a Windows PC that is connected to the same network as this unit.
- 2 Start iTunes and click the AirPlay icon to select this unit.

[Example] iTunes



3 Choose a song and click play in iTunes.

The music will stream to this unit.



- When “Network Control” is set to “On”, you can turn on this unit by operating iTunes. (🔧 p. 98)
- For information about how to use iTunes, also see the Help for iTunes.



Play a song from your iPhone, iPod touch, iPad or Mac on multiple synced devices (AirPlay 2)

Songs from an iPhone, iPod touch, iPad or Mac can be synced with multiple AirPlay 2 supported devices for simultaneous playback.

1 Play the song on your iPhone, iPod touch, iPad or Mac.

AirPlay icon is displayed on the iPhone, iPod touch, iPad or Mac screen.

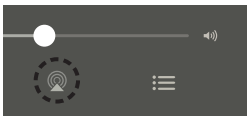

2 Tap or click the AirPlay icon and select this unit.

Displays a list of devices/speakers that can be played back on the same network.

- A circle is displayed to the right of AirPlay 2 compatible devices.

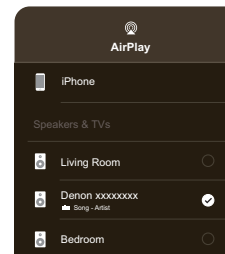

3 Select the devices/speakers you want to use.

- Multiple AirPlay 2 compatible devices can be selected.

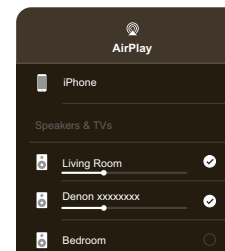

- To use AirPlay 2, your iOS device must support iOS 11.4 or later, or macOS Catalina or later.



Spotify Connect function

Spotify is all the music you'll ever need. Millions of songs available instantly. Just search for the music you love, or let Spotify play you something great. Spotify works on your phone, tablet, computer and home speakers. So you'll always have the perfect soundtrack for whatever you're doing. Now you can enjoy Spotify with your free account as well as Premium account.

Use your phone, tablet or computer as a remote control for Spotify.

Go to www.spotify.com/connect to learn how.

The Spotify software is subject to third party licenses found here:

www.spotify.com/connect/third-party-licenses

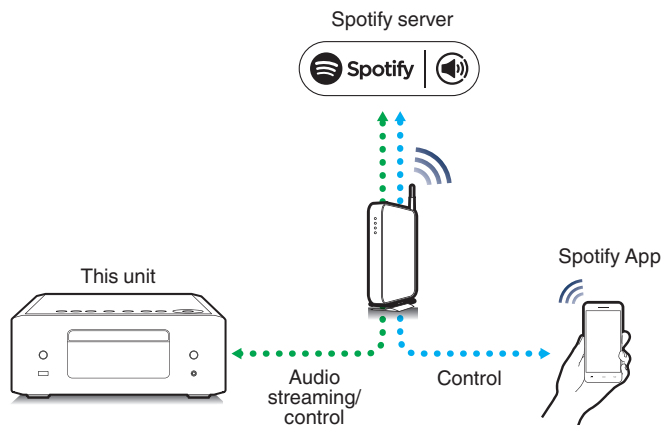

Playing Spotify music with this unit

Download the "Spotify App" onto your iOS or Android device beforehand.

- 1** Connect the Wi-Fi settings of the iOS or Android device in the same network as this unit.
- 2** Launch the Spotify App.
- 3** Play back the Spotify track.
- 4** Tap the Spotify icon  to select the unit.
The music will stream to this unit.



Convenience functions

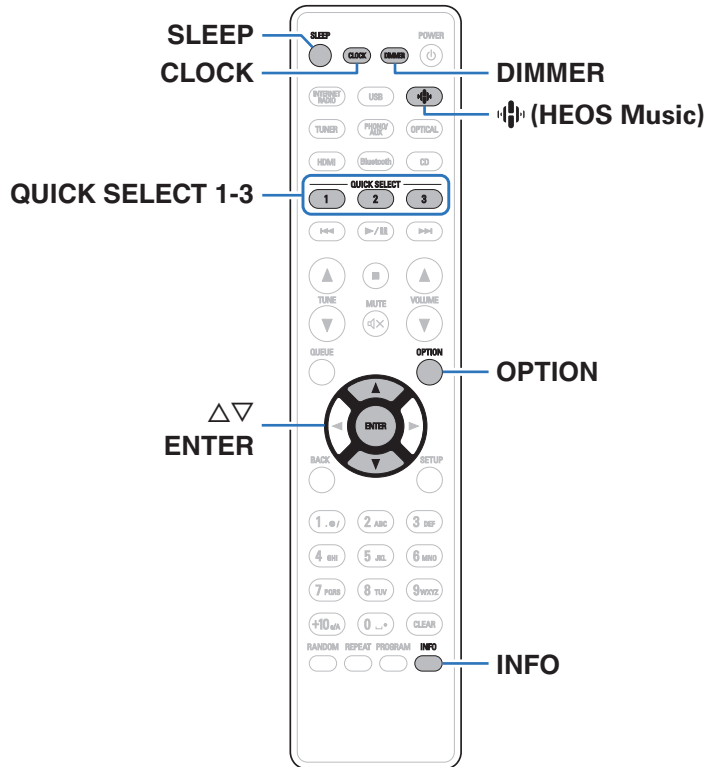

- This section explains how to use convenient functions that can be used for each input source.
- Control of “HEOS Favorites” operations is optimized for the app. For more information on acquiring the app, see “Getting the HEOS app” (👉 p. 48).



Playing back HEOS Favorites

When using the HEOS Favorites function for the first time on this unit, create a HEOS Account on the HEOS app or sign in to your account. Once you create or sign into your HEOS Account, you can use the HEOS Favorites feature to save and recall your favorite streaming radio stations using this unit.

1 Press (HEOS Music).

If a playback history is present, the last Internet radio station or song played is played back. Pressing  (HEOS Music) again displays the HEOS Music top menu.

2 Use $\Delta\nabla$ to select “Favorites”, then press ENTER.

3 Use $\Delta\nabla$ to select the content you would like to playback, then press ENTER.

4 Use $\Delta\nabla$ to select “Play Now”, then press ENTER.



- You can select content you would like to playback from your HEOS Favorites by pressing 0-9 and +10.
- You can no longer select Favorites from the HEOS Music top menu when this unit is not synced with a HEOS Account in the HEOS app.

Adding to HEOS Favorites

This function only works for streamed content.

1 While content is playing, press OPTION.

The option menu screen is displayed.

2 Use $\Delta\nabla$ to select “Add to HEOS Favorites”, then press ENTER.

3 Use $\Delta\nabla$ to select the “HEOS Favorites” number you would like to save your contents to, then press ENTER.



Deleting a HEOS Favorites

- 1 Press  (HEOS Music).**

If a playback history is present, the last Internet radio station or song played is played back. Pressing  (HEOS Music) again displays the HEOS Music top menu.
- 2 Use $\Delta\nabla$ to select “Favorites”, then press ENTER.**
- 3 While the HEOS Favorites content list is displayed, use $\Delta\nabla$ to select the item you want to remove from HEOS Favorites, then press ENTER.**
- 4 Use $\Delta\nabla$ to select “Remove from HEOS Favorites”, then press ENTER.**

Switching the display's brightness

The display brightness can be adjusted between five levels.

- 1 Press DIMMER.**
 - The brightness of the display switches each time the button is pressed.



- When “Off” is set, the display turns on temporarily when operating the buttons.
- The display brightness is set to most brightly by default.



Using the sleep timer

You can have the power automatically switched to standby once a set time has elapsed. This is convenient for listening while going to sleep.

1 Press SLEEP during playback and select the setting time.

- The  indicator on the display lights.
- The sleep timer can be set to up to 90 minutes, in steps of 10 minutes.
- After about 5 seconds, the setting is entered and the display returns to as it was before.

■ To cancel the sleep timer

1 Press SLEEP to set “Sleep ► Off”.

The  indicator on the display turns off.



- The sleep timer setting is canceled when the unit switches to standby mode.
- To check the time remaining until the sleep timer is activated, press SLEEP.

Checking the current time

Be sure to set the current time using “Clock” in the setup menu in advance. ( p. 92)

■ Checking the current time when the power is on

Press CLOCK.

- Press once more and the display returns to its original condition.

■ Checking the current time when the power is set to standby

Press CLOCK.

- The current time is displayed for 30 seconds.



- The time cannot be set when in the standby mode. Turn on the power first.
- Pressing the INFO button while the clock is displayed in standby mode temporarily displays the alarm settings. If there are no previously set alarms, no alarms are displayed.



Quick select function

Settings such as the input source, volume level and “SDB/Tone” in the setup menu can be registered to the QUICK SELECT 1 - 3 buttons. You can simply press one of the registered QUICK SELECT buttons in subsequent playbacks to switch to the group of saved settings in a batch. By saving frequently used settings at the QUICK SELECT 1 – 3 buttons, you will always be able to easily call up the same playback environment.

■ Calling up the settings

1 Press QUICK SELECT.

The quick select settings registered to the button you pressed are called up.

- The default settings for the input source are as shown below.

Button	Input source
QUICK SELECT 1	Internet Radio
QUICK SELECT 2	Tuner
QUICK SELECT 3	Bluetooth



- Volume is not registered to quick select in the factory default settings. See “Changing the settings” to register volume to quick select. (👉 p. 80)

■ Changing the settings

1 Set the items below to the settings you want to register.

- ① Input source (👉 p. 32)
- ② Volume (👉 p. 32)
- ③ “SDB/Tone” in the setup menu (👉 p. 87)



- Press and hold QUICK SELECT while a radio station is being received is being played back with any of the following sources, the current radio station is memorized.
 - Tuner / Internet Radio Station / Spotify

2 Press and hold the desired QUICK SELECT for more than 3 seconds.

“Saved” appears on the display and the current settings will be memorized.



Menu map

For menu operations, see the following page.

By default, this unit has recommended settings defined. You can customize this unit based on your existing system and your preferences.

Setting items	Detailed items	Description	Page
Audio	SDB/Tone	Adjust the sound to your preference.	87
	Volume Limit	Make a setting for maximum volume. The volume cannot be increased above this setting.	87
	H/P Amplifier Gain	Set the gain of the headphone amplifier. By setting according to the impedance of your headphone, you can enjoy playing headphones at an appropriate volume.	88
	Speaker Optimization	The speaker output characteristics are changed and settings are configured according to our SC-N10 speakers (not included).	88
TV	TV Input	Set this when playing audio from a TV on this unit.	89
	HDMI Power Off Control	Set the “HDMI Power Off Control” function that is keyed to the power off operation of your TV to turn the device’s power to standby.	90



Setting items	Detailed items	Description/Detailed items	Page	
General	Alarm	Sets the timer playback.	91	
	Clock	Sets the current time.	92	
	Clock Mode	You can display the time when in standby by setting the clock mode.	93	
	IR Control	Assign operations on this unit to the remote control of your TV. This enables you to operate this unit with the remote control of your TV.	93	
	CD Auto Play	Set whether to automatically play a disc when the disc is inserted.	94	
	Language	Sets the language for display the menu.	94	
	Auto-Standby	Sets the unit power to standby when the unit is not in use.	94	
	Information		Displays notifications. Also, sets whether or not to display the notification when the power is turned on.	95
			Notification Alerts	95
			Check for Notifications	95
Reset	Various settings are reset to the factory default values.	95		
Network	Network Information	Displays various information about the network.	96	
	Wi-Fi	The Wi-Fi function can be stopped to prevent noise that affects the sound quality.	96	
	Bluetooth	Stopping Bluetooth function reduces a source of noise that affects sound quality, enabling higher sound quality playback. It also sets the Bluetooth transmitter settings.	97	
	Network Control	Performs the on/off settings for the network function when in standby mode.	98	
	AirPlay Setup	Set this unit to WAC mode. Perform this setup when connecting to a network using an iOS device.	98	



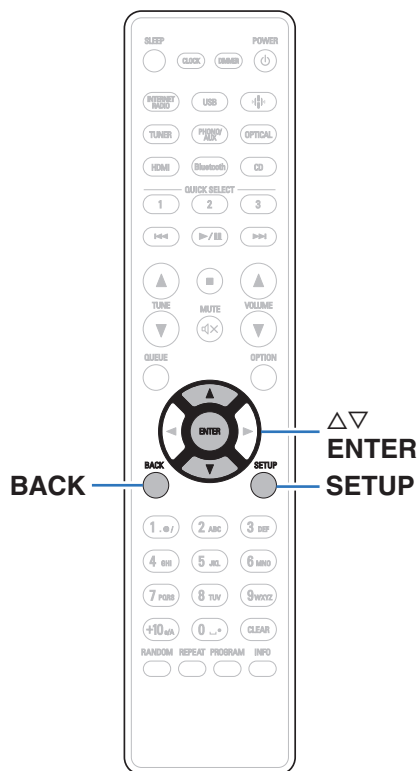

Menu operation

- 1 Press SETUP.**
The menu is displayed on the display.
- 2 Use Δ / ∇ to select the menu to be set or operated, then press ENTER.**
- 3 Use Δ / ∇ to change to desired setting.**
- 4 Press ENTER to enter the setting.**
 - To return to the previous item, press BACK.
 - Exiting the Menu, press SETUP while the menu is displayed. The display returns to the normal display.



Inputting characters

Using the number buttons

- 1 **Display the screen for inputting characters.**
 - To change a character, use <|> to align the cursor with the character that you want to change.
- 2 **Press +10 to select the character type (upper case, lower case, characters with diacritical marks or numeric characters).**

3 Use 0 – 9, +10 until the desired character is displayed.

- The types of characters that can be input are as shown in the following table.

1	. @ - _ / :
2	abc ABC 2 ä à á â ã ä å æ ç ç Ä Å Ä Å Æ Ç Ç Ć
3	def DEF 3 ð è é ê ë ð Ë È É Ê
4	ghi GHI 4 ï ï ï ï ï ï ï
5	ijkl IJKL 5
6	mno MNO 6 ñ ò ó ô õ ø Ñ Ò Ó Ô Õ Ø
7	pqr PQR 7 Þ ÿ š š š Þ Ŕ Ŗ Š Š Š
8	tuv TUV 8 ü ú ú ú Ü Û Ú Û
9	wxyz WXYZ 9 ý ž ž þ Ý Ž Ž Þ
0	(Space) ! " # \$ % & ' () * + , ; < = > ? [\] ^ _ { } ¡ ¢ £ ¤ ¥ © « ¬ ± » ¿



3 Repeat step 2 to input characters then press ENTER to register it.



- Press CLEAR to erase the character that is currently selected.
- Press and hold CLEAR for 3 seconds or more to erase all characters.
- Press ►►I to insert a space.



Audio

Make audio-related settings.

SDB/Tone

Adjust the sound to your preference.

■ Super Dynamic Bass

On:	Emphasizes the bass sound (maximum +8 dB).
Off (Default):	Disable SDB (Super Dynamic Bass) function.

■ Bass

Adjusts the bass sound.

-10 dB – +10 dB (Default : 0 dB)

■ Treble

Adjusts the treble sound.

-10 dB – +10 dB (Default : 0 dB)

■ Balance

Use <|> to adjust the left/right volume balance.

■ Source Direct

On:	Playback sound is closer to the source sound.
Off (Default):	Do not use Source Direct function.

Volume Limit

Make a setting for maximum volume. The volume cannot be increased above this setting.

Off (Default): Do not set a maximum volume. (100)

95 / 90 / 85 / 80



H/P Amplifier Gain

Set the gain of the headphone amplifier. Set this according to the impedance of the connected headphones. It is recommended that this is set on the “Low” side if the headphones have low impedance and on the “High” side if they have high impedance.

High:	Set the gain of the headphone amplifier to “High”. Set this if the volume is too low at the factory default setting.
Mid (Default):	Set the gain of the headphone amplifier to “Mid”.
Low:	Set the gain of the headphone amplifier to “Low”. Set this if the volume is too high at the factory default setting.

NOTE

- The headphone volume varies depending on the H/P Amplifier Gain setting. Decrease the volume or mute the audio first if changing this setting while listening to audio.

Speaker Optimization

Performs audio processing optimized to our SC-N10 speakers (not included) and outputs an audio signal.

On (Default):	Performs audio processing optimized to our SC-N10 speakers (not included).
Off:	The response is flat.



TV

TV Input

Set this when playing audio from a TV on this unit. When the TV is turned on, this unit turns on and the input source is automatically switched to "HDMI" or "Optical" so that the audio from the TV can be played through this unit.

■ Default Input

Set the input source to be used when playing audio from the TV through this unit. Set this according to the jack on this unit being used to connect to the TV (HDMI ARC or OPTICAL IN).

None / HDMI Out (ARC) / Optical In
(Default: HDMI Out (ARC))

■ Auto-Play

When a TV audio source is input to this unit, the unit automatically switches to the input source set in "Default Input" and the Auto-Play function for playing TV audio on this unit is set.

On
(Default): Enables the Auto-Play function.

Off: Disables the Auto-Play function.



- The Auto-Play function does not work when "Default Input" is set to "None". Set "Default Input" in advance.
- The Auto-Play function will not work if the sampling frequency of the audio signal input from this unit's OPTICAL IN input terminal is 88.2 kHz or more. TVs normally output 48 kHz audio signals and the Auto-Play function will work, but if you connect a device that outputs an audio signal of 88.2 kHz or more and try to use it, the Auto-Play function may not work.



HDMI Power Off Control

Set the “HDMI Power Off Control” function that is keyed to the power off operation of your HDMI connected TV to turn the device's power to standby.

All (Default) :	Regardless of the input source of this device, if the power of the TV is turned off, the power of this device automatically becomes standby.
HDMI ARC:	If the input source is HDMI and you power off the TV, the power of this device automatically becomes standby.
Off:	This unit is not linked to the power of the TV.



General

Alarm

Audio from the set input source can be played back at a specified time. Use this to set playback for the same time every day, or set alarm playback on a certain day of the week.

■ Alarm 1

On: Enables Alarm 1.

Off: Disables Alarm 1.

■ Alarm 2

On: Enables Alarm 2.

Off: Disables Alarm 2.

■ Edit Alarm

Used to edit Alarm 1 or Alarm 2.

- 1 Use Δ / ∇ to select “Alarm 1” or “Alarm 2”, then press ENTER.
- 2 Use Δ / ∇ to setting for the alarm start time, then press ENTER.
- 3 Use Δ / ∇ to change to desired setting, then press ENTER.

Never: Alarm is not repeated. (single time only)

Everyday: Alarm is repeated every day.

Weekdays: Alarm is repeated on weekdays (Mon. to Fri.) only.

Weekends: Alarm is repeated on weekends (Sat., Sun.) only.

Custom: Used to set alarm on/off settings individually for each day of the week. Alarm is repeated only for days set to on.



4 Use $\Delta\nabla$ to select the input source, then press ENTER.

 CD / Tuner / HDMI / Optical / Phono / AUX



- When "Tuner" is selected, select a preset number.

5 Use $\Delta\nabla$ to select the volume level "0 – 100", then press ENTER.

Displays the alarm settings.

6 Check the displayed alarm settings and press ENTER.

The display shows "Complete!!" and the setting is completed.

Clock**■ Set the current time**

You can automatically adjust the clock of this unit using the Internet.



- To use this function, the unit must be connected to the Internet.

1 Use $\Delta\nabla$ to select your time zone (Time Zone), then press ENTER.**2 Use $\Delta\nabla$ to select the DST (Daylight Saving Time), then press ENTER.**

On:	Set the DST (Daylight Saving Time) to on.
Off (Default):	Set the DST (Daylight Saving Time) to off.



Clock Mode

You can display the time when in standby by setting the Clock Mode.

On:	Time is displayed in standby.
Off (Default):	Time is not displayed in standby.



- When in standby and “Clock Mode” is set to “On”, the unit consumes more standby power than when in normal standby.

IR Control

Assign operations on this unit to the remote control of your TV. This enables you to operate this unit with the remote control of your TV.

1 Use Δ / ∇ to select the operation on this unit to be performed with the remote control of your TV and press ENTER.

Volume Up / Volume Down / Mute / Power Toggle / Power On / Power Off / Quick Select 1 / Quick Select 2 / Quick Select 3 / Input HDMI Out (ARC) / Input Optical In / Input AUX In



- The operations indicated by a check mark are already assigned to the TV remote control. To assign an operation to a different button, press ENTER while the operation is indicated by a check mark to remove the check mark, then configure the setting again.

2 Follow the instructions in the display to configure the setting.

The set operation on this unit is indicated by a check mark after the setting is complete.



CD Auto Play

When the disc tray is closed, the unit can detect the CD, automatically switch the input source to "CD" and start playback.

On (Default):	Performs automatic playback.
Off:	Does not perform automatic playback.

Language

Sets the language for display the menu.

English / Français / Español (Default : English)

Auto-Standby

Sets the amount of time that must elapse without unit operation or an input signal before the unit goes into standby automatically.

Off (Default):	The unit does not go into standby automatically.
1min:	The unit goes into standby after 1 minutes.
5min:	The unit goes into standby after 5 minutes.
15min:	The unit goes into standby after 15 minutes.
Other:	Sets the minutes (between 1 and 99) before the unit automatically goes into standby. After setting the amount of time with 0 – 9, +10 buttons, press ENTER to confirm the setting.



Information

■ Notification Alerts

Sets whether or not to display the notification when the power is turned on.

On
(Default): Notification messages are displayed.

Off: Notification messages are not displayed.

■ Check for Notifications

Displays notifications.

Reset

Perform this procedure if the display is abnormal or if operations cannot be performed. Restores the contents of each setting to the factory settings. Make settings again.

Reset factory defaults: Unit is initialized.

Cancel: Unit is not initialized.



Network

Network Information

Displays network information.

Friendly Name / Connection / SSID / DHCP / IP Address / MAC Address (Ethernet) / MAC Address (Wi-Fi)

Wi-Fi

The Wi-Fi function can be stopped to prevent noise that affects the sound quality. Using a wired LAN to connect this unit to the network enables playback with a high sound quality.

On (Default):	Enables the Wi-Fi function.
Off:	Disables the Wi-Fi function.



Bluetooth

Bluetooth

Stopping Bluetooth receiver and transmitter functions reduces a source of noise that affects sound quality, enabling higher sound quality playback.

On (Default):	Enables the Bluetooth function.
Off:	Disables the Bluetooth function.

Headphone

Enables or disables the Bluetooth headphones transmitter. Perform these settings when you are listening to audio playback of this unit with Bluetooth headphones.

On	Enables the Bluetooth headphones transmitter feature.
Off (Default):	Disables the Bluetooth headphones transmitter feature.

Output Mode

Selects the audio output method.

HP + Speakers (Default) :	Audio is output to Bluetooth headphones and speakers.
Headphones:	Audio is output to Bluetooth headphones only.

Devices

- Available devices are displayed in the list once you start pairing mode on the Bluetooth headphones you want to connect. Select your Bluetooth headphones from the list to pair them.
- This unit can only pair with one Bluetooth headphone at a time. However, up to 8 Bluetooth headphones can be registered. Switch between registered devices from “Devices” in the “Bluetooth” setup menu.
- To remove a saved Bluetooth device from the list, use the $\Delta \nabla$ buttons to select it, then press the OPTION button and select “Forget This Device”.



- A2DP profile-compatible Bluetooth speakers can be connected following the same steps used to connect Bluetooth headphones.

NOTE

- Bluetooth transmitter and Bluetooth receiver function cannot be used at the same time. Bluetooth transmitter function is not available when listening to music on a Bluetooth device.
- Even when “Headphone” is set to “On”, press Bluetooth on the remote control to select the “Bluetooth” source and enable the Bluetooth receiver function. To listen to music stored on Bluetooth devices such as smartphones on this unit, press Bluetooth on the remote control to switch the input source to Bluetooth, then reconnect the Bluetooth device.
- Menu settings for Bluetooth headphones transmitter are not available when this unit is grouped within the HEOS app.
- Bluetooth headphones cannot be connected if a HEOS built-in device is playing an input source from this unit.



Network Control

Enables network communication in standby power mode.

On (Default):	Network is on during standby. Main unit operable with a network compatible controller.
Off:	Suspend network function during standby.



- When using the HEOS app, use with the “Network Control” setting set to “On”.

NOTE

- When “Network Control” is set to “On”, the unit consumes more standby power.

AirPlay Setup

This unit supports the “WAC (Wi-Fi Accessory Configuration)” setup mode of Apple Inc. In the WAC setup mode, use your iOS device (iPhone/iPod/iPad) to connect to the network. By connecting your iOS device with this unit, this unit can be automatically connected to the same network.

1. Select “AirPlay Setup” and press ENTER.
 - This unit switches to the WAC setup mode.
2. At the bottom of the Wi-Fi setup screen for iOS devices, select “Denon CEOL” from “SET UP NEW AIRPLAY SPEAKER...”.
 - Make sure the iOS device is connected to the wireless LAN (Wi-Fi) router.
3. Select a network to connect this device and press “Next”.
4. Follow the on-screen instructions to complete the connection.
 - When connected, “Connected” is shown on the display.

NOTE

- The firmware version of your iOS device must support iOS 10.0.2 or later.
- The WAC setup mode lasts approximately 15 minutes. If the setup is not completed within 15 minutes, the WAC setup mode is canceled automatically. If you cancel the WAC setup mode manually, press the BACK button.



Connecting to the network by using the WPS button on the router

If you are using a wireless router that supports WPS (Wi-Fi Protected Setup™), connect to the network with the “push button method”. (Wi-Fi Protected Setup™ is trademarks of Wi-Fi Alliance.)

- 1 Press the WPS button on your router.**
- 2 Within 2 minutes, press and hold the CONNECT button on the rear panel for 5 seconds.**

“WPS Connecting” is shown on the display and the connection is started.

- When connected, “WPS Connected” is shown on the display.



- You can also press and hold  (HEOS Music) on the remote control for 5 seconds to enter WPS setup mode.
- The CONNECT light on the rear panel lights up or flashes depending on the network connection status. It lights in amber when this unit is not connected to a network.



■ Contents

Tips

I want to listen to high sound performance playback	101
I want to adjust the tone myself	101
I want sound playback that is faithful to the original sound	101
I want to play TV audio at higher quality	101
I want to prevent this unit from going into standby by linking to the power off operation of an HDMI connected TV	101
I want to turn the display off	102
I want to display the clock constantly	102
I want to make the volume of the headphones the same as that of the speakers	102
Simple operations in the power off state	102
I want the volume not to become too loud by mistake	102

Troubleshooting

Power does not turn on/Power is turned off	104
Light is flashing	104
Operations cannot be performed through the remote control unit	106
Display on this unit shows nothing	106
No sound comes out	107
Sound is interrupted or noise occurs	108
Desired sound does not come out	110
AirPlay cannot be played back	111
USB flash drives cannot be played back	112
File names on the USB flash drive are not displayed properly	113
Bluetooth cannot be played back	113
The Internet radio cannot be played back	116
Music files on PC or NAS cannot be played back (Music server)	117
Various online services cannot be played	118
Cannot connect to a wireless LAN network	118
Cannot playback Discs	119
Audio from digital devices cannot be played back (HDMI/Optical)	120
The input source switches to "HDMI" or "Optical"	120
The HDMI control function does not work	120
Update/upgrade error messages	121



Tips

I want to listen to high sound performance playback

- The Wi-Fi function can be stopped to prevent noise that affects the sound quality. Set “Wi-Fi” to “Off” in the setup menu. (👉 p. 96)
- Stopping Bluetooth function reduces a source of noise that affects sound quality, enabling higher sound quality playback. Set “Bluetooth” to “Off” in the setup menu. (👉 p. 97)

I want to adjust the tone myself

- Set “Super Dynamic Bass”, “Bass”, “Treble” and “Balance” in the setting menu. (👉 p. 87)

I want sound playback that is faithful to the original sound

- Set “Source Direct” in the setting menu to “On”. (👉 p. 87)

I want to play TV audio at higher quality

- Connect the HDMI terminal of your TV that supports the ARC function to the HDMI ARC terminal of this unit and switch the input source to HDMI. (👉 p. 22)
- If you are using a TV that does not support the ARC function or a TV that does not have an HDMI terminal, the TV audio can be played by this unit using an Optical connection. (👉 p. 22)
- Only 2-channel linear PCM can be input as the digital audio signal to this unit.

I want to prevent this unit from going into standby by linking to the power off operation of an HDMI connected TV

- Change the “HDMI Power Off Control” setting to “Off”. (👉 p. 90)



I want to turn the display off

- Press the DIMMER button to turn the display off. (👉 p. 78)

I want to display the clock constantly

- The clock can be constantly displayed by setting “Clock Mode” to “On”. (👉 p. 93)

I want to make the volume of the headphones the same as that of the speakers

- You can increase the sound from the headphones at the same volume setting by changing the “H/P Amplifier Gain” settings. (👉 p. 88)

Simple operations in the power off state

- When an input source select button, ▶/⏸ button and QUICK SELECT buttons on the remote control, as well as ▲ button, QUICK SELECT keys and ▶/⏸/ENTER key on the main unit is pressed, the operation is performed at the same time as the unit switches on.
- When the “Network Control” function is set to “On”, you can perform playback, or other operations through AirPlay or HEOS app. (👉 p. 98)

I want the volume not to become too loud by mistake

- Set the volume upper limit for “Volume Limit” in the menu beforehand. This prevents children or others from increasing the volume too much by mistake. (👉 p. 87)



Troubleshooting

If a problem should arise, first check the following:

1. Are the connections correct?
2. Is the set being operated as described in the owner's manual?
3. Are the other devices operating properly?



- If steps 1 to 3 above do not improve the problem, restarting the device may improve the problem.
Continue pressing the  button on the unit until "Restart" appears in the display, or remove and re-insert the power cord of the unit.



If this unit does not operate properly, check the corresponding symptoms in this section.

If the symptoms do not match any of those described here, consult your dealer as it could be due to a fault in this unit. In this case, disconnect the power immediately and contact the store where you purchased this unit.



Power does not turn on / Power is turned off

Power is not turned on.

- Check whether the power plug is correctly inserted into the power outlet. (👉 p. 29)
- This unit is in standby mode. Press the  button on the main unit or the POWER  button on the remote control. (👉 p. 31)

Power automatically turns off.

- The sleep timer is set. Turn on the power again. (👉 p. 79)
- “Auto-Standby” is set. “Auto-Standby” is triggered when there is no operation for a set amount of time. To disable “Auto-Standby”, set “Auto-Standby” on the menu to “Off”. (👉 p. 94)
- “HDMI Power Off Control” is set. The power of this unit turns off (standby) by linking to the power off operation of an HDMI connected TV. To disable “HDMI Power Off Control”, set “HDMI Power Off Control” on the setup menu to “Off”. (👉 p. 90)

Light is flashing

The power turns off and the power indicator shows one long blink and two short blinks in red.

- Stop playback on the playback device, and then turn the power off and on again.
- If the problem is not solved by turning the power off and on again, this unit’s amplifier circuit has failed. Unplug the power cord and contact our customer service center.

The power turns off and the power indicator shows one long blink and three short blinks in red.

- This unit’s power circuit has failed. Unplug the power cord and contact our customer service center.



The power turns off and the power indicator shows one long blink and four short blinks in red.

- The protection circuit has been activated due to a rise in temperature within this unit. Turn the power off, wait about an hour until this unit cools down sufficiently, and then turn the power on again.
- Please re-install this unit in a place having good ventilation.
- Stop playback on the playback device, and then turn the power off and on again.
- If the problem is not solved by turning the power off and on again, unplug the power cord and contact our customer service center.

The power turns off and the power indicator shows one long blink and five short blinks in red.

- Check the speaker connections. The protection circuit may have been activated because speaker cable core wires came in contact with each other or a core wire was disconnected from the connector and came in contact with the rear panel of this unit. After unplugging the power cord, take corrective action such as firmly re-twisting the core wire or taking care of the connector, and then reconnect the wire. (🔧 p. 19)
- Stop playback on the playback device, and then turn the power off and on again.
- If the problem is not solved by turning the power off and on again, this unit's amplifier circuit or power circuit has failed. Unplug the power cord and contact our customer service center.

The power turns off and the power indicator shows one long blink and six short blinks in red.

- This unit's power circuit has failed. Unplug the power cord and contact our customer service center.

Flashing orange.

- The clock is incorrect because the AC was temporarily switched off, etc. Check the network connection and adjust the clock. (🔧 p. 92)



Operations cannot be performed through the remote control unit

Operations cannot be performed through the remote control unit.

- Batteries are worn out. Replace with new batteries. (🔍 p. 8)
- Operate the remote control unit within a distance of about 23 ft/7 m from this unit and at an angle of within 30°. (🔍 p. 8)
- Remove any obstacle between this unit and the remote control unit.
- Insert the batteries in the proper direction, checking the ⊕ and ⊖ marks. (🔍 p. 8)
- The unit's remote control sensor is exposed to strong light (direct sunlight, inverter type fluorescent bulb light, etc.). Move the set to a place in which the remote control sensor will not be exposed to strong light.
- When using a 3D video device, the remote control unit of this unit may not function due to effects of infrared communications between units (such as TV and glasses for 3D viewing). In this case, adjust the direction of units with the 3D communications function and their distance to ensure they do not affect operations from the remote control unit of this unit.
- Operations on this unit can be assigned to the remote controls of devices such as a TV using the "IR Control" function of the unit. Please note, however, that some remote controls may not be compatible with the "IR Control" function. (🔍 p. 93)

Display on this unit shows nothing

Display is off.

- Press the DIMMER button, and change the setting to anything other than off. (🔍 p. 78)



No sound comes out

No sound is produced. Or sound is distorted.

- Check the connections for all devices. (🔗 p. 18)
- Insert connection cables all the way in.
- Check that input connectors and output connectors are not reversely connected.
- Check cables for damage.
- Check that speaker cables are properly connected. Check that cable core wires come in contact with the metal part on speaker terminals. (🔗 p. 19)
- Securely tighten the speaker terminals. Check speaker terminals for looseness. (🔗 p. 19)
- Check that the proper input source is selected. (🔗 p. 32)
- Adjust the volume. (🔗 p. 32)
- Cancel the mute mode. (🔗 p. 32)
- Check that the correct input source is selected when audio is being input to this unit from an external device. (🔗 p. 32)
- Check the digital audio output setting on the connected device. The initial settings may be off depending on the device.
- No sound is output from the speakers when headphones are connected. (🔗 p. 11)
- Do not input non-PCM signals, such as Dolby Digital and DTS. This causes noise and could damage the speakers.
- To playback via a Bluetooth connection, perform pairing between this unit and the Bluetooth device. (🔗 p. 41)
- Audio is output to your Bluetooth headphones, but not to speakers or audio outs when "Output Mode" set to "Headphones". Change "Output Mode" to "HP + Speakers" to output audio from your Bluetooth headphones as well as your speakers or audio outs. (🔗 p. 45)



Sound is interrupted or noise occurs

During playback from the Internet radio or USB flash drive, sound is occasionally interrupted.

- When the transfer speed of the USB flash drive is slow, sound may occasionally be interrupted.
- The network communication speed is slow or the radio station is busy.

When making a call on mobile phone, noise occurs in audio output on this unit.

- When making a call, keep a distance of 0.7 ft/20 cm or longer between mobile phone and this unit.

During playback from the CD-R/CD-RW, sound is occasionally interrupted.

- The sound may skip during playback of a CD-R/CD-RW containing a high-resolution audio source.
- This may be caused by poor recording conditions, or the disc itself may be of poor quality. Use a correctly recorded disc.

Sound cuts out when using Wi-Fi connection.

- The frequency band used by the wireless LAN is also used by microwave ovens, cordless telephones, wireless game controllers and other wireless LAN devices. Using such devices at the same time as this unit may cause sound to cut out due to electronic interference. Sound cut out can be improved using the following methods. (🔗 p. 27)
 - Install devices that cause interference away from this unit.
 - Turn off the power supply to devices that cause interference.
 - Change the settings of the router channel to which this unit is connected to. (See the instruction manual of the wireless router for details on how to change the channel.)
 - Switch to a wired LAN connection.
- Particularly when you play back large music files, depending on your wireless LAN environment, the playback sound may be interrupted. In this case, make the wired LAN connection. (🔗 p. 96)

Noise often occurs in FM/AM broadcasting.

- Change the antenna orientation or position. (🔗 p. 25)
- Use an outdoor antenna. (🔗 p. 25)
- Separate the AM loop antenna from the unit. (🔗 p. 25)
- Separate the antenna from other connection cables. (🔗 p. 25)



When playing a record, the sound is distorted.

- Adjust to a proper needle pressure.
- Check the tip of the needle.
- Replace the cartridge.

When playing a record, a humming noise comes out of the speakers.

- Check that the turntable is connected correctly. (👉 p. 23)
- If there is a TV or AV device near the turntable, such devices may affect the playback sound. Install the turntable in a location as far away as possible from the TV or other AV devices.

When playing a record, a humming noise comes out of the speakers when the volume is high. (Howling phenomenon)

- Install the turntable and speakers as far from each other as possible. (👉 p. 23)
- The vibrations from the speakers are being transmitted to the player through the floor. Use cushions, etc., to absorb the speakers' vibrations.



Desired sound does not come out

The volume does not increase.

- The maximum volume is set too low. Set the maximum volume using “Volume Limit” on the menu. (👉 p. 87)

Headphone volume is low.

- Switch “H/P Amplifier Gain” to “High” if using headphones with high impedance or low sensitivity. (👉 p. 88)

Left/right volume balance is unbalanced.

- Set “Balance” in the setup menu. (👉 p. 87)

No sound is produced from subwoofer.

- Check the subwoofer connections. (👉 p. 20)
- Turn on the subwoofer’s power.

Set values are not reflected in “SDB/Tone” in the setup menu.

- “Super Dynamic Bass”, “Bass” and “Treble” setting values are not reflected in audio out or subwoofer out.
- Set “Off” to “Source Direct” in the setup menu. (👉 p. 87)
- This unit cannot adjust “SDB/Tone” in the setup menu for audio output to Bluetooth headphones.



AirPlay cannot be played back

The AirPlay icon is not displayed on iTunes / iPhone / iPod touch / iPad / Mac.

- This unit and PC / iPhone / iPod touch / iPad are not connected to the same network (LAN). Connect it to the same LAN as this unit. (👉 p. 27)
- The firmware on iTunes / iPhone / iPod touch / iPad / Mac is not compatible with AirPlay. Update the firmware to the latest version.

Audio is not output.

- The volume on iTunes / iPhone / iPod touch / iPad / Mac is set to the minimum level. The volume on iTunes / iPhone / iPod touch / iPad / Mac is linked with the volume on this unit. Set a proper volume level.
- The AirPlay playback is not performed, or this unit is not selected. Click the AirPlay icon on the iTunes / iPhone / iPod touch / iPad / Mac screen and select this unit. (👉 p. 73)

Audio is interrupted during the AirPlay playback on iPhone / iPod touch / iPad / Mac.

- Quit the application running in the background of the iPhone / iPod touch / iPad / Mac, and then play using AirPlay.
- Some external factors may be affecting the wireless connection. Modify the network environment by taking measures such as shortening the distance from the wireless LAN access point.



USB flash drives cannot be played back

USB flash drive is not recognized.

- Disconnect and reconnect the USB flash drive. (👉 p. 24)
- Mass storage class compatible USB flash drives are supported.
- This unit does not support a connection through a USB hub. Connect the USB flash drive directly to the USB port.
- The USB flash drive must be formatted to FAT32 or NTFS.
- Not all USB flash drives are guaranteed to work. Some USB flash drives are not recognized. When using a type of portable hard disc drive compatible with the USB connection that requires power from an AC adapter, use the AC adapter that came with the drive.

Files on the USB flash drive are not displayed.

- Files of a type not supported by this unit are not displayed. (👉 p. 38)
- This unit is able to display files in a maximum of eight folder layers. A maximum of 5000 files (folders) can also be displayed for each layer. Modify the folder structure of the USB flash drive.
- When multiple partitions exist on the USB flash drive, only files on the first partition are displayed.

iOS and Android devices are not recognized.

- The USB port of this unit does not support playback from iOS and Android devices.

Files on a USB flash drive cannot be played.

- Files are created in a format that is not supported by this unit. Check the formats supported by this unit. (👉 p. 127)
- You are attempting to play a file that is copyright protected. Files that are copyright protected cannot be played on this unit.
- Playback may not be possible if the album art file size exceeds 2 MB.



File names on the USB flash drive are not displayed properly

The file names are not displayed properly (“...”, etc.).

- Characters that cannot be displayed are used. This is not a malfunction. Characters that cannot be displayed have been used. On this unit, characters that cannot be displayed are replaced with a “. (period)”.

Bluetooth cannot be played back

Bluetooth devices cannot be connected to this unit.

- The Bluetooth function in the Bluetooth device has not been enabled. See the Owner’s Manual of the Bluetooth device to enable the Bluetooth function.
- Bring the Bluetooth device near to this unit.
- The Bluetooth device cannot connect with this unit if it is not compatible with the A2DP profile.
- Turn the power of the Bluetooth device off and on again, and then try again.
- Set “Bluetooth” in the setup menu to “On”. The Bluetooth function does not work when “Bluetooth” is “Off”. (🔧 p. 97)

Smartphones and other Bluetooth devices cannot be connected.

- Smartphones and other Bluetooth devices cannot be connected when “Headphone” is set to “On”. Press Bluetooth on the remote control to switch the input source to Bluetooth, then connect the device. (🔧 p. 97)



Cannot connect Bluetooth headphones.

- Bring the Bluetooth headphones near to this unit.
- Turn the power of the Bluetooth headphones off and on again, and then try again.
- Go to “Network” - “Bluetooth”, and set “Headphone” to “On” within the setup menu. (👉 p. 97)
- Make sure this unit is not already connected to another pair of Bluetooth headphones. Check the currently connected Bluetooth headphones in the “Devices” menu. (👉 p. 97)
Disconnect the connected Bluetooth headphones before connecting the ones you want to use.
- Bluetooth headphones cannot be connected if Bluetooth is being used as an input source.
- Bluetooth headphones cannot be connected if this unit is grouped in the HEOS app. Remove this unit from the group to enable Bluetooth headphones connection.
- Bluetooth headphones cannot be connected if a HEOS built-in device is playing an input source from this unit.
- The Bluetooth headphones cannot connect with this unit if it is not compatible with the A2DP profile.
- Connection and operation are not guaranteed for all Bluetooth-enabled devices.
- This unit can only connect to one Bluetooth headphone at a time. However, up to 8 Bluetooth headphones can be registered. You can switch between registered devices from “Devices” in the “Bluetooth” menu. (👉 p. 97)



The sound is cut off.

- Bring the Bluetooth device near to this unit.
- Remove obstructions between the Bluetooth device and this unit.
- To prevent electromagnetic interference, locate this unit away from microwave ovens, wireless LAN devices and other Bluetooth devices.
- Reconnect the Bluetooth device.

The sound is cut off or noise occurs when using Bluetooth headphones.

- Move the Bluetooth headphones closer to this unit.
- Remove obstructions between the Bluetooth headphones and this unit.
- Reconnect the Bluetooth headphones.
- To prevent electromagnetic interference, locate this unit away from microwave ovens, wireless LAN devices and other Bluetooth devices.
- We recommend using wired LAN to connect this unit and other devices.
- Bluetooth transmits on the 2.4 GHz band which may interfere with Wi-Fi transmitted on this band. Connect this unit and other devices to Wi-Fi network on a 5 GHz band if available on your Wi-Fi router.

Audio is delayed on my Bluetooth headphones.

- This unit cannot adjust audio delay on Bluetooth headphones.



The Internet radio cannot be played back

A list of broadcasting stations is not displayed.

- The LAN cable is not properly connected, or the network is disconnected. Check the connection status. (👉 p. 27)

Internet Radio cannot be played.

- The selected radio station is broadcasting in a format that is not supported by this unit. Formats that can be played back in this unit are WMA, MP3 and MPEG-4 AAC. (👉 p. 133)
- The firewall function is enabled on the router. Check the firewall setting.
- Check the power of the router is on.
- Some radio stations broadcast silently during some time period. In this case, no audio is output. Wait for a while and select the same radio station, or select another radio station. (👉 p. 34)
- The selected radio station is not in service. Select a radio station in service.

Cannot connect to favorite radio stations.

- Radio station is not currently in service. Register radio stations in service.



Music files on PC or NAS cannot be played back (Music server)

Files stored on a computer cannot be played.

- Files are stored in a non-compatible format. Record in a compatible format. (👉 p. 132)
- Files that are copyright protected cannot be played on this unit.
- Even if PC is connected to the USB port on this unit, music files on it cannot be played back. Connect PC to this unit through the network. (👉 p. 27)
- Media sharing settings on the server or NAS do not allow this unit. Change the settings to allow this unit. For details, see the owner's manual of the server or NAS.

Server is not found, or it is not possible to connect to the server.

- The computer's or router's firewall is activated. Check the computer's or router's firewall settings.
- Computer's power is not turned on. Turn on the power.
- Server is not running. Launch the server.

Files on PC or NAS are not displayed.

- Files of a type not supported by this unit are not displayed. (👉 p. 132)

Music stored on a NAS cannot be played.

- If you use a NAS in conformity with the DLNA standard, enable the DLNA server function in the NAS setting.
- If you use a NAS that does not conform with the DLNA standard, play the music via a PC. Set Windows Media Player's media sharing function and add NAS to the selected play folder.
- If connection is restricted, set audio equipment as the connection target.



Various online services cannot be played

Various online services cannot be played.

- The online service may have been discontinued.

Cannot connect to a wireless LAN network

Cannot connect to the network.

- Make sure your mobile device is connected to your wireless network before setting up this unit. (🔍 p. 49)
- You can connect this unit to your network router using an Ethernet cable sold separately. Once connected via Ethernet, the HEOS app should recognize this unit and you can manually move it to your wireless network using “Settings” - “My Devices” - (“Device Name”) - “Network”.
- Shorten the distance from the wireless LAN access point and remove any obstructions to improve access first before re-connecting again. Place the unit away from microwave ovens and other network access points.
- Configure the access point channel settings away from channels that are being used by other networks.
- This unit is not compatible with WEP (TSN).

Cannot connect to a WPS Router.

- Check that the WPS mode of the router is operating.
- After you press the WPS button on the router, within two minutes, press and hold the CONNECT button on the rear panel for 5 seconds. (🔍 p. 99)
- A router/settings that are compatible with WPS 2.0 standards are required. Set the encryption time to “None”, WPA-PSK (AES) or WPA2-PSK (AES).
- If the router encryption method is WEP/WPA-TKIP/WPA2-TKIP, you cannot connect by using the WPS button on the router. In this case, connect using the HEOS app or connect by sharing the Wi-Fi setting of your iOS device. (🔍 p. 99)

Cannot connect to the network using iPhone/iPod touch/iPad.

- Update the iPhone/iPod touch/iPad firmware to the latest version.
- When configuring the settings via a wireless connection, iOS 10.0.2 or later needs to be supported.



Cannot playback Discs

Cannot playback when the play button is pressed, or cannot correctly play back a specific part of the disc.

- The disc is dirty or scratched. Either clean the disc, or insert a different disc. (👉 p. 130)

Cannot playback CD-R/CD-RW.

- Discs cannot be played back unless they have been finalized. Use a finalized disc. (👉 p. 124)
- This may be caused by poor recording conditions, or the disc itself may be of poor quality. Use a correctly recorded disc.
- Files are created in a format that is not supported by this unit. Check the formats supported by this unit. (👉 p. 125)

“No Disc” is displayed.

- “No Disc” is displayed if the disc is loaded upside-down or if no disc is loaded.

“System Error” is displayed.

- “System Error” is displayed when an error not caused by disc, format, etc., occurs. Contact our customer service center.

“Can’t Read Disc” is displayed.

- “Can’t Read Disc” is displayed when the inserted disc cannot be read because it is not compatible with this unit or is dirty or scratched. Check the disc.

“Wrong Format” is displayed.

- “Wrong Format” is displayed for files created in a format that is not supported by this unit. Check the formats supported by this unit. (👉 p. 125)



Audio from digital devices cannot be played back (HDMI/Optical)

“Signal Unlock” is displayed.

- When digital audio signals cannot be detected properly, “Signal Unlock” is displayed. (🔍 p. 69)

“Unsupported” is displayed.

- “Unsupported” is displayed when audio signals that are not supported by this unit are input. Check the audio output signal format from your digital device. (🔍 p. 69)
- Only the PCM 2-channel setting can be used to play sound from a TV via the HDMI ARC function. Set “PCM 2ch” as the audio format in the TV settings.

The input source switches to “HDMI” or “Optical”

The input source automatically switches to “HDMI” or “Optical” when the TV connected to this unit is turned on.

- Set “Off” to “Auto-Play”. (🔍 p. 89)

The HDMI control function does not work

The HDMI control function does not work.

- You cannot operate devices that are not compatible with the HDMI control function. In addition, depending on the connected device or the settings, the HDMI control function may not work. In this case, operate the external device directly.
- Check that the HDMI control function setting is enabled on TV connected to this unit.



Update/upgrade error messages

If an update/upgrade is interrupted or fails, an error message appears.

Display	Description
Connection failed. Please check your network, then try again.	The network connection is unstable. Connection to the server failed. Check your network environment and try the update again.
Update failed. Please check your network, then try again.	The download of the firmware failed. Check your network environment and try the update again.
Upgrade failed. Please check your network, then try again.	The download of the firmware failed. Check your network environment and try the upgrade again.
Please check your network, unplug and reconnect the power cord, and try again.	The update failed. Press and hold the  on the main unit for more than 5 seconds, or remove and re-insert the power cord. The update restarts automatically.
Please contact customer service in your area.	This unit may be broken. Contact our Customer Service Center in your area.



Resetting network settings

If network contents cannot be played or the unit cannot connect to the network, restarting the unit may improve the problem. We recommend restarting the unit before returning the settings to the default settings. (☞ p. 103)

If the operations are not improved by restarting the unit, follow the steps below.

Network settings are reset to the factory default values. Make settings again.

However, the menu “Audio” settings are not reset.

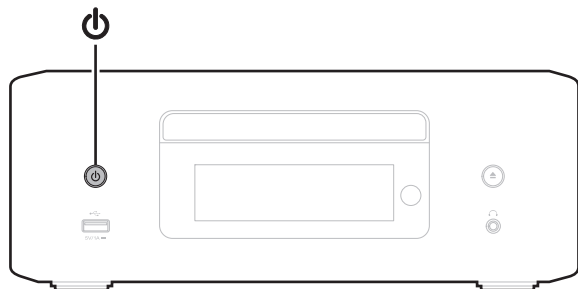
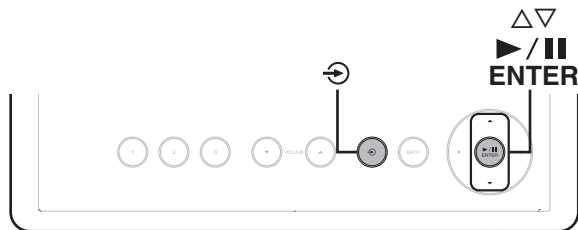

- 1 Press ⏻ on the main unit to turn on power to the unit.
- 2 Touch ⏻ on the main unit and select “HEOS”.
- 3 Use ▲▼ on the main unit to select “Internet Radio”, “Music Servers” or “USB Music”.
- 4 When the power to this unit is on, press and hold ⏻ for 3 seconds or more while touching ▶/⏻/ENTER.
- 5 Remove your fingers from the two buttons when “Please wait” appears on the display.
- 6 “Completed” is shown in the display when reset is complete.

NOTE

- Do not turn the power off until reset is complete.



Factory Restore

When the unit or the network functions do not work properly, operation may be improved by restoring the firmware to the factory defaults.

Perform this operation if it does not work after attempting “General” - “Reset” of the settings menu. (🔧 p. 95)

After performing the Factory Restore, various settings are reset to the default settings. Configure the network settings and update the firmware again.

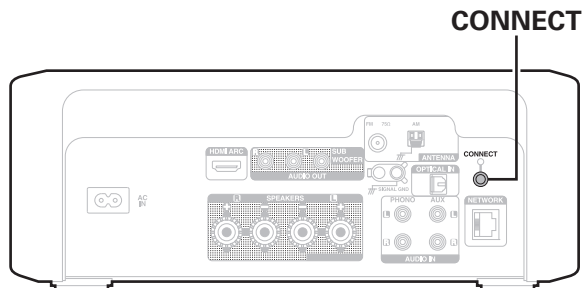

- 1 Unplug the power cord from the power outlet.**
- 2 Plug in the power cord while holding down CONNECT.**
- 3 When “Factory Restore” appears on the display, release the buttons.**

When the Factory Restore is complete, “Factory Restore Completed” appears on the display for about 5 seconds, and the unit automatically restarts.



- This operation takes time because it requires reconnecting to the network, restoring and updating the firmware.
- If this operation does not improve the problem, contact our customer service center.

NOTE



- Do not turn off the power until the Factory Restore is complete.

WARNING

By initiating Factory Restore mode, you will be installing limited recovery firmware on this unit. Functionality will remain limited until a firmware update is performed over the Internet. Do not perform a Factory Restore if you do not have this unit connected to your home network.



Playing back Discs

Playable media	
CD	
CD-R	
CD-RW	

NOTE

- Some discs and some recording formats cannot be played.
- Non-finalized discs cannot be played.

Files

CD-R and CD-RW discs created in the format described below can be played.

■ Writing software format

ISO9660 level 1

- When written in other formats, it may not be possible to play the disc properly.

■ Maximum number of playable files and folders

Total number of folders and files : 512

Maximum number of folders : 256

■ File format

MPEG-1 Audio Layer-3

WMA (Windows Media Audio)

■ Tag data

ID3-TAG (Ver.1.x and 2.x)

META-Tag (Compatible with title, artist and album names)



■ Specifications of supported files

	Sampling frequency	Bit rate	Extension
MP3	32/44.1/48 kHz	48 – 320 kbps	.mp3
WMA	32/44.1/48 kHz	48 – 320 kbps	.wma

NOTE

- Be sure to give files the extension. Files with any other extensions or files with no extensions cannot be played.
- Mac OS files assigned with filenames that begin with “.” are not music data and cannot be played back.
- Recordings you have made should only be used for your personal enjoyment, and as per copyright laws may not be used in other ways without permission of the copyright holder.



- Only music files that are not copyright-protected can be played on this unit.
 - Content downloaded from pay sites on the Internet are copyright protected. Also, files encoded in WMA format when ripped from a CD, etc. on a computer may be copyright protected, depending on the computer's settings.
- The maximum number of files and folders that can be played differs depending on conditions such as the length of the file name or folder name or the number of levels in the folder hierarchy.

Playback order of music files

When there are multiple folders containing music files, the playback order of folders is automatically set when this unit reads the media. Files in each folder are played in alphabetical order of file name.

CD-R/CD-RW

For playback of files on CD-R or CD-RW, files in all folders on the first layer are played first, next on the second layer, then next on the third layer, and so on in this order.



- The playback order displayed on a PC may differ from the actual playback order.
- The playback order with a CD-R/CD-RW may differ, depending on the writing software.



About discs and files

Music files recorded on CD-R/CD-RW are divided into large segments (folders) and small segments (files). Files are stored in folders, and folders can be placed for storage in a hierarchy. The unit can recognize up to 16 levels of folders.

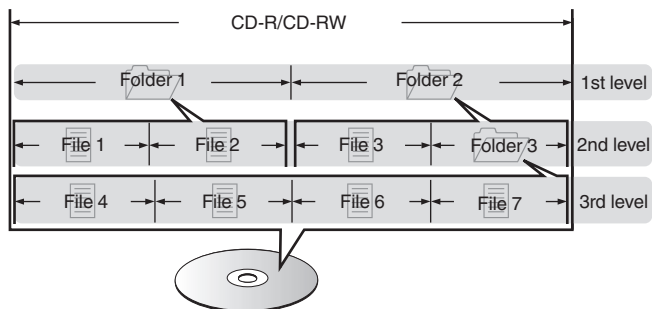

- When writing music files on a CD-R/CD-RW disc, set the writing software's format to "ISO9660". The files may not play properly if they are recorded in other formats. For details, refer to the instructions of your writing software.



Playing back a USB flash drives

- This unit is compatible with MP3 ID3-Tag (Ver. 2) standard.
- This unit is compatible with WMA META tags.
- If the image size (pixels) of an album artwork exceeds 500 × 500 (WMA/MP3/Apple Lossless/DSD) or 349 × 349 (MPEG-4 AAC), then music may not be played back properly.

■ Specifications of supported files

	Sampling frequency	Bit rate	Extension
WMA*1	32/44.1/48 kHz	48 – 192 kbps	.wma
MP3	32/44.1/48 kHz	32 – 320 kbps	.mp3
WAV	32/44.1/48/88.2/ 96/176.4/192 kHz	–	.wav
MPEG-4 AAC*1	32/44.1/48 kHz	48 – 320 kbps	.aac/.m4a
FLAC	44.1/48/88.2/ 96/176.4/192 kHz	–	.flac
Apple Lossless*2	44.1/48/88.2/ 96/176.4/192 kHz	–	.m4a
DSD	2.8/5.6 MHz	–	.dsf/.dff

*1 Only files that are not protected by copyright can be played on this unit.
Content downloaded from pay sites on the Internet are copyright protected. Also, files encoded in WMA format when ripped from a CD, etc. on a computer may be copyright protected, depending on the computer's settings.

*2 The Apple Lossless Audio Codec (ALAC) decoder is distributed under the Apache License, Version 2.0 (<http://www.apache.org/licenses/LICENSE-2.0>).



■ Maximum number of playable files and folder

The limits on the number of folders and files that can be displayed by this unit are as follows.

Item	Media	USB flash drive
Number of folder directory levels *1		8 levels
Number of folders		500
Number of files*2		5000

*1 The limited number includes the root folder.

*2 The allowable number of files may differ according to the USB flash drive capacity and the file size.



Cautions on using media

Inserting a disc

- Set the disc in the tray label side up.
- Make sure the disc tray is fully open when inserting the disc.
- Place the discs flatly, 5 inch/12 cm discs in the outer tray guide (Figure 1), 3 inch/8 cm discs in the inner tray guide (Figure 2).

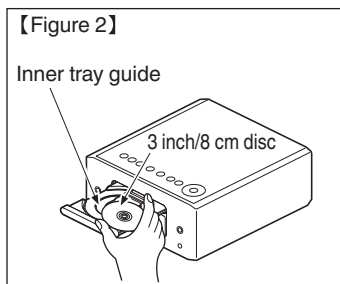
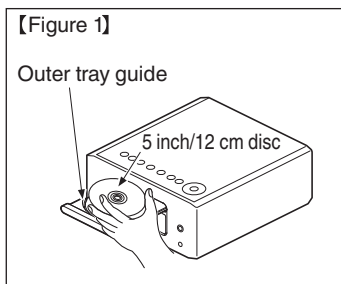

- Place 3 inch/8 cm discs in the inner tray guide without using an adapter.

NOTE

- Only load one disc at a time. Loading two or more discs can damage the unit or scratch the discs.
- Do not use cracked or warped discs or discs that have been repaired with adhesive, etc.
- Do not use discs on which the sticky part of cellophane tape or labels is exposed or on which there are traces of where labels have been removed. Such discs can get caught inside the player and damage it.
- Do not use discs in special shapes, as they may damage the unit.



- Do not push the disc tray in by hand when the power is off. Doing so could damage the unit.
- Do not place any foreign objects in the disc tray. Doing so could result in damage.
- If the unit is left in a room full of smoke from cigarettes, etc., for long periods of time, the surface of the optical pickup may get dirty, preventing it from receiving signals properly.



How to handle media

- Do not get fingerprints, oil or dirt on discs.
- Take special care not to scratch discs when removing them from their cases.
- Do not bend or heat discs.
- Do not enlarge the hole in the center.
- Do not write on the labeled (printed) surface with ball-point pens, pencils, etc., or stick new labels on discs.
- Condensation may form on discs if they are moved suddenly from a cold place (outdoors for example) to a warm place, but do not try to dry discs with a hairdryer, etc.
- Do not eject a USB flash drive or turn off the unit while a USB flash drive is being played. This may result in malfunction or loss of the USB flash drive's data.
- Do not attempt to open or modify a USB flash drive.
- USB flash drive and files can be damaged by static electricity. Do not touch the metal contacts of a USB flash drive with your fingers.
- Do not use warped USB flash drive.
- After use, be sure to remove any disc or USB flash drive, and store it in its proper case, to avoid dust, scratches and deformation.
- Do not store discs in the following places:
 1. Places exposed to direct sunlight for long periods of time
 2. Dusty or humid places
 3. Places exposed to heat from heaters, etc.

Cleaning discs

- If there are fingerprints or dirt on a disc, wipe them off before using the disc.
- Use a commercially available disc cleaning set or a soft cloth to clean discs.



Gently wipe the disc from the inside towards the outside.

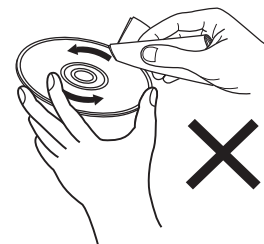

Do not wipe with a circular motion.

NOTE

- Do not use record spray, antistatic agents, benzene, thinner or other solvents.



Digital input

■ Specifications of supported audio formats

□ HDMI ARC/Optical

	Sampling frequency	Bit length
Linear PCM (2-channel)	32/44.1/48/88.2/96/ 176.4/192 kHz	16/24 bits

Playing back a Bluetooth device

This unit supports the following Bluetooth profile.

- A2DP (Advanced Audio Distribution Profile):
When a Bluetooth device that supports this standard is connected, monaural and stereo sound data can be streamed at a high quality.
- AVRCP (Audio/Video Remote Control Profile):
When a Bluetooth device that supports this standard is connected, the Bluetooth device can be operated from this unit.

■ About Bluetooth communications

Radio waves broadcast from this unit may interfere with the operation of medical devices. Make sure you turn off the power of this unit and Bluetooth device in the following locations as radio wave interference may cause malfunctions.

- Hospitals, trains, aircraft, petrol kiosks and places where flammable gases are generated
- Near automatic doors and fire alarms



Playing back files stored on a PC and NAS

- This unit is compatible with MP3 ID3-Tag (Ver. 2) standard.
- This unit is compatible with WMA META tags.
- If the image size (pixels) of an album artwork exceeds 500 × 500 (WMA/MP3/WAV/FLAC) or 349 × 349 (MPEG-4 AAC), then music may not be played back properly.
- A server or server software compatible with distribution in the corresponding formats is required to play music files via a network.

For playing mentioned audio formats via a network a server software, for example Twonky Media Server or jRiver Media Server, needs to be installed on your computer or NAS for full support. There are other server software available too. Please check supported formats.

■ Specifications of supported files

	Sampling frequency	Bit rate	Extension
WMA*1	32/44.1/48 kHz	48 – 192 kbps	.wma
MP3	32/44.1/48 kHz	32 – 320 kbps	.mp3
WAV	32/44.1/48/88.2/96/ 176.4/192 kHz	–	.wav
MPEG-4 AAC*1	32/44.1/48 kHz	48 – 320 kbps	.aac/.m4a
FLAC	44.1/48/88.2/ 96/176.4/192 kHz	–	.flac
Apple Lossless*2	44.1/48/88.2/ 96/176.4/192 kHz	–	.m4a
DSD	2.8/5.6 MHz	–	.dsf/.dff

*1 Only files that are not protected by copyright can be played on this unit.

Content downloaded from pay sites on the Internet are copyright protected. Also, files encoded in WMA format when ripped from a CD, etc., on a computer may be copyright protected, depending on the computer's settings.

*2 The Apple Lossless Audio Codec (ALAC) decoder is distributed under the Apache License, Version 2.0 (<http://www.apache.org/licenses/LICENSE-2.0>).



Playing back Internet Radio

■ Playable broadcast station specifications

	Sampling frequency	Bit rate	Extension
WMA	32/44.1/48 kHz	48 – 192 kbps	.wma
MP3	32/44.1/48 kHz	32 – 320 kbps	.mp3
MPEG-4 AAC	32/44.1/48 kHz	48 – 320 kbps	.aac/ .m4a

Last function memory

This function stores the settings which were made before going into the standby mode.



About HDMI

This unit supports the following HDMI functions.

- **ARC (Audio Return Channel) function**

Enjoy movies, music, etc., on your TV simply by connecting an ARC function-compatible TV to this unit via HDMI.

- **HDMI control function**

Connect an HDMI control-compatible TV and this unit via HDMI and enable the HDMI control to enable linked control from either device.

- Input source switching

If the TV is turned on, this unit automatically powers on and switches the input source.

- Power off link

The TV power off operation is linked so this unit also turns off.

- Volume adjustment

The volume of this unit can be adjusted using the TV remote control.

- Audio output destination switching

If this unit is turned on, TV audio is output from this unit. If this unit is turned off, TV audio is output from the speakers of the TV.



- Some functions may not operate depending on the connected TV.



Explanation of terms

■ Audio

Apple Lossless Audio Codec

This is a codec for lossless audio compression method developed by Apple Inc. This codec can be played back on iTunes, iPod or iPhone. Data compressed to approximately 60 – 70 % can be decompressed to exactly the same original data.

DSD (Direct-Stream Digital)

One of the audio data recording methods, it is the signal aspect used to store audio signals on a super audio CD, and is Δ - Σ modulated digital audio.

FLAC (Free Lossless Audio Codec)

FLAC stands for Free lossless Audio Codec, and is a lossless free audio file format. Lossless means that the audio is compressed without any loss in quality.

The FLAC license is as shown below.

Copyright (C) 2000,2001,2002,2003,2004,2005,2006,2007,2008,2009
Josh Coalson

Redistribution and use in source and binary forms, with or without modification, are permitted provided that the following conditions are met:

- Redistributions of source code must retain the above copyright notice, this list of conditions and the following disclaimer.
- Redistributions in binary form must reproduce the above copyright notice, this list of conditions and the following disclaimer in the documentation and/or other materials provided with the distribution.
- Neither the name of the Xiph.org Foundation nor the names of its contributors may be used to endorse or promote products derived from this software without specific prior written permission.



THIS SOFTWARE IS PROVIDED BY THE COPYRIGHT HOLDERS AND CONTRIBUTORS "AS IS" AND ANY EXPRESS OR IMPLIED WARRANTIES, INCLUDING, BUT NOT LIMITED TO, THE IMPLIED WARRANTIES OF MERCHANTABILITY AND FITNESS FOR A PARTICULAR PURPOSE ARE DISCLAIMED. IN NO EVENT SHALL THE FOUNDATION OR CONTRIBUTORS BE LIABLE FOR ANY DIRECT, INDIRECT, INCIDENTAL, SPECIAL, EXEMPLARY, OR CONSEQUENTIAL DAMAGES (INCLUDING, BUT NOT LIMITED TO, PROCUREMENT OF SUBSTITUTE GOODS OR SERVICES; LOSS OF USE, DATA, OR PROFITS; OR BUSINESS INTERRUPTION) HOWEVER CAUSED AND ON ANY THEORY OF LIABILITY, WHETHER IN CONTRACT, STRICT LIABILITY, OR TORT (INCLUDING NEGLIGENCE OR OTHERWISE) ARISING IN ANY WAY OUT OF THE USE OF THIS SOFTWARE, EVEN IF ADVISED OF THE POSSIBILITY OF SUCH DAMAGE.

MP3 (MPEG Audio Layer-3)

This is an internationally standardized audio data compression scheme, using the "MPEG-1" video compression standard. It compresses the data volume to about one eleventh its original size while maintaining sound quality equivalent to a music CD.

MPEG (Moving Picture Experts Group), MPEG-2, MPEG-4

These are the names for digital compression format standards used for the encoding of video and audio. Video standards include "MPEG-1 Video", "MPEG-2 Video", "MPEG-4 Visual", "MPEG-4 AVC". Audio standards include "MPEG-1 Audio", "MPEG-2 Audio", "MPEG-4 AAC".

WMA (Windows Media Audio)

This is the audio compression technology developed by Microsoft Corporation.

WMA data can be encoded using Windows Media® Player.

To encode WMA files, only use applications authorized by Microsoft Corporation. If you use an unauthorized application, the file may not work properly.



Sampling frequency

Sampling involves taking a reading of a sound wave (analog signal) at regular intervals and expressing the height of the wave at each reading in digitized format (producing a digital signal).

The number of readings taken in one second is called the “sampling frequency”. The larger the value, the closer the reproduced sound is to the original.

Speaker impedance

This is an AC resistance value, indicated in Ω (ohms).

Greater power can be obtained when this value is smaller.

Bit rate

This expresses the read amount per 1 second of video/audio data recorded in a disc. A larger number means higher sound quality, but also means a larger file size.

■ Network

AirPlay

AirPlay sends (plays) contents recorded in iTunes or on an iPhone / iPod touch / iPad / Mac to a compatible device via the network.

WEP Key (network key)

This is key information used for encrypting data when conducting data transfer. On this unit, the same WEP key is used for data encryption and decryption, so the same WEP key must be set on both devices in order for communications to be established between them.

Wi-Fi®

Wi-Fi Certification assures tested and proven interoperability by the Wi-Fi Alliance, a group certifying interoperability among wireless LAN devices.

WPA (Wi-Fi Protected Access)

This is a security standard established by the Wi-Fi Alliance. In addition to the conventional SSID (network name) and WEP key (network key), it also uses a user identification function and encrypting protocol for stronger security.

WPA2 (Wi-Fi Protected Access 2)

This is a new version of the WPA established by the Wi-Fi Alliance, compatible with more secure AES encryption.



WPA/WPA2-Personal

This is a simple authentication system for mutual authentication when a preset character string matches on the wireless LAN access point and client.

WPA2/WPA3-Personal

WPA2/WPA3-Personal Mode was defined by Wi-Fi Alliance® to minimize user disruption and provide a gradual migration path to WPA3-Personal while maintaining interoperability with WPA2-Personal only devices.

WPA3-Personal

WPA3-Personal replaces the WPA2-Personal Pre-Shared Key (PSK) authentication with Simultaneous authentication of equals (SAE). Unlike PSK, SAE is resistant to offline dictionary attacks.

Network Names (SSID: Service Set Identifier)

When forming wireless LAN networks, groups are formed to prevent interference, data theft, etc. These groups are based on “SSID (network names)”. For enhanced security, a WEP key is set so that communication is unavailable unless both the “SSID” and the WEP key match. This is suitable for constructing a simplified network.

■ Other

Finalizing

This process enables DVD/CD recorded with a recorder to be played by other players.

Pairing

Pairing (registration) is an operation that is required in order to connect a Bluetooth device to this unit using Bluetooth. When paired, the devices authenticate each other and can connect without mistaken connections occurring.

When using Bluetooth connection for the first time, you need to pair this unit and the Bluetooth device to be connected.

Protection circuit

This is a function to prevent damage to devices within the power supply when an abnormality such as an overload, excess voltage occurs or over temperature for any reason.



Trademark information



Apple, AirPlay, iPad, iPad Air, iPad Pro, iPhone and Mac are trademarks of Apple Inc., registered in the U.S. and other countries.

The trademark "iPhone" is used in Japan with a license from Aiphone K.K.

Use of the Works with Apple badge means that an accessory has been designed to work specifically with the technology identified in the badge and has been certified by the developer to meet Apple performance standards.



The Bluetooth® word mark and logos are registered trademarks owned by the Bluetooth SIG, Inc. and any use of such marks by DEI Sales, Inc. is under license. Other trademarks and trade names are those of their respective owners.



The Wi-Fi CERTIFIED logo is a registered trademark of the Wi-Fi Alliance.

Wi-Fi Certification provides assurance that the device has passed the interoperability test conducted by the Wi-Fi Alliance, a group that certifies interoperability among wireless LAN devices.



The terms HDMI, HDMI High-Definition Multimedia Interface, HDMI trade dress and the HDMI Logos are trademarks or registered trademarks of HDMI Licensing Administrator, Inc.



App Store® is registered in the U.S. and other countries.



Google Play and the Google Play logo are trademarks of Google LLC.



Specifications

■ Audio amplifier

- CD player

Playable frequency response:

10 Hz – 20 kHz

Wow & flutter:

Below measurable limits (± 0.001 %)

Sampling frequency:

44.1 kHz

- Audio amplifier

Rated output:

2-channel

65 W + 65 W (4 Ω /ohms, 1 kHz, THD + N 0.7 %)

Dynamic power:

80 W + 80 W (4 Ω /ohms, 1 kHz, THD+N 10 %)

Output terminals:

Speaker: 4-16 Ω /ohms (impedance)

Compatible with headphones/stereo headphones

Tone control:

SDB : +8 dB (100 Hz)

Bass : ± 10 dB (100 Hz)

Treble : ± 10 dB (10 kHz)



- AUX

Input sensitivity/impedance:	200 mV/30 k Ω /kohms
Frequency response:	10 Hz – 40 kHz (\pm 3 dB)
S/N Ratio (10 W, 4 Ω /ohms, IHF-A):	90 dB
Total harmonic distortion (1 kHz, 5 W, 4 Ω /ohms):	0.1 %

- PHONO

Input sensitivity/impedance:	2.5 mV/47 k Ω /kohms
Frequency response:	RIAA deviation (20 Hz - 20 kHz)
S/N Ratio (IHF-A):	74 dB

■ Tuner section

Receiving Range:	[FM] 87.5 MHz – 107.9 MHz	[AM] 520 kHz – 1710 kHz
Effective sensitivity:	1.2 μ V / 75 Ω /ohms	20 μ V
FM Channel separation:	42 dB (1 kHz)	
FM S/N ratio:	Monaural : 70 dB Stereo : 70 dB	
FM THD+N (1 kHz):	Monaural : 0.4 % Stereo : 0.4 %	



■ Wireless LAN section

Network type (wireless LAN standard):	Conforming to IEEE 802.11a/b/g/n/ac (Wi-Fi® compliant) *1
Security:	WEP 64 bit, WEP 128 bit WPA/WPA2-PSK (AES) WPA/WPA2-PSK (TKIP) WPA3-SAE (AES)
Used frequency range:	2.4 GHz, 5 GHz

*1 The Wi-Fi® CERTIFIED Logo and the Wi-Fi CERTIFIED On-Product Logo are registered trademarks of the Wi-Fi Alliance.



■ Bluetooth section

Communications system:	Bluetooth Specification Version 5.0
Transmission power:	Bluetooth Specification Power Class 1
Maximum communication range:	Approx. 98.4 ft/30 m in line of sight *2
Used frequency range:	2.4 GHz
Modulation scheme:	FHSS (Frequency-Hopping Spread Spectrum)
Supported profiles:	Receiver function A2DP (Advanced Audio Distribution Profile) 1.2 AVRCP (Audio Video Remote Control Profile) 1.3 Transmitter function A2DP (Advanced Audio Distribution Profile) 1.2
Corresponding codec:	SBC
Transmission range (A2DP):	20 Hz – 20,000 Hz

*2 The actual communication range varies depending on the influence of such factors as obstructions between devices, electromagnetic waves from microwave ovens, static electricity, cordless phones, reception sensitivity, antenna performance, operating system, application software etc.



■ Clock/Alarm/Sleep

Clock type:	Power line frequency synchronized method (Within ± 60 seconds per month)
Alarm:	Once alarm/Everyday alarm: One system each
Sleep:	Sleep timer: Max. 90 minutes

■ General

Operating temperature:	41 °F - 95 °F (5 °C - 35 °C)
Power supply:	AC 120 V, 60 Hz
Power consumption:	55 W
Power consumption in standby mode :	0.2 W
Power consumption in “Network Control” – “On” mode:	2 W

- For purposes of improvement, specifications and design are subject to change without notice.



■ Dimensions (Unit : in. (mm))

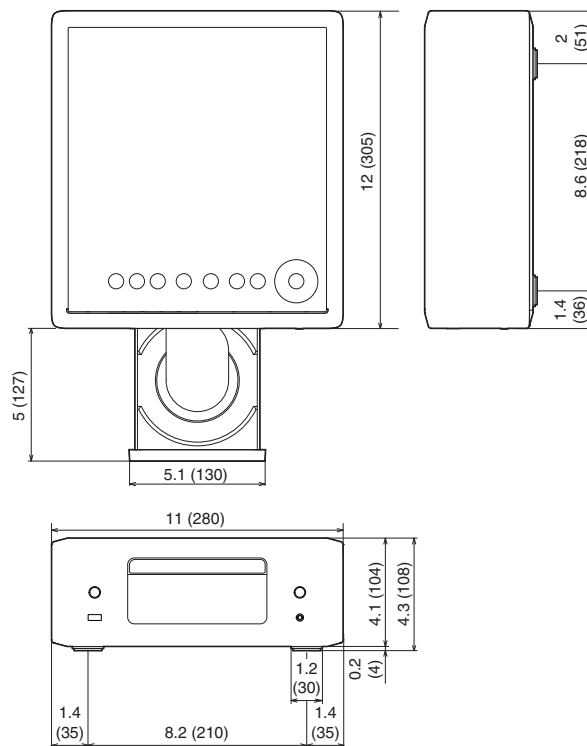

■ Weight : 7 lbs 8 oz (3.4 kg)

Index

A		F		M	
AirPlay	72	Front panel	9	Menu map	81
Auto Standby	94	H		N	
B		HEOS Account	51	NAS	35, 132
Bluetooth device	41	HEOS Favorites	77	Network settings	96
C		I		P	
CD	59	Input source	32	Pairing	41
D		Inputting characters	84	PC	27, 35, 132
DATA CD	62	Internet Radio	33	Program playback	61
Display's brightness	78			Q	
				Queue	36, 39, 54



**R**

Rear panel	12
Remote control unit	14
Resetting network settings	122

**S**

Sleep timer	79
Spotify	75

**T**

Tips	101
Troubleshooting	103

**U**

USB flash drive	24, 38
-----------------------	--------

**W**

Wired LAN	27
Wireless LAN	28



DENON®

www.denon.com

3520 10940 00AS

© 2023 DEI Sales, Inc. All Rights Reserved.