

DENON

AV SURROUND RECEIVER

AVR-5805

OPERATING INSTRUCTIONS

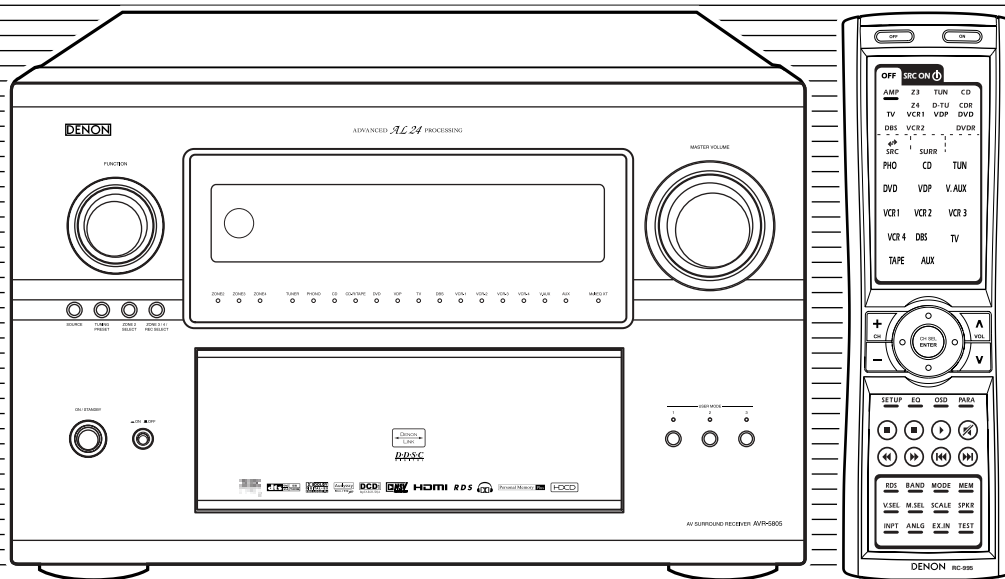

- We greatly appreciate your purchase of the AVR-5805.
- To be sure you take maximum advantage of all the features the AVR-5805 has to offer, read these instructions carefully and use the set properly. Be sure to keep this manual for future reference should any questions or problems arise.

“SERIAL NO. _____

PLEASE RECORD UNIT SERIAL NUMBER ATTACHED TO THE REAR OF THE CABINET FOR FUTURE REFERENCE”

SAFETY PRECAUTIONS



CAUTION
RISK OF ELECTRIC SHOCK
DO NOT OPEN



CAUTION: TO REDUCE THE RISK OF ELECTRIC SHOCK, DO NOT REMOVE COVER (OR BACK). NO USER-SERVICEABLE PARTS INSIDE. REFER SERVICING TO QUALIFIED SERVICE PERSONNEL.

The lightning flash with arrowhead symbol, within an equilateral triangle, is intended to alert the user to the presence of uninsulated "dangerous voltage" within the product's enclosure that may be of sufficient magnitude to constitute a risk of electric shock to persons.

The exclamation point within an equilateral triangle is intended to alert the user to the presence of important operating and maintenance (servicing) instructions in the literature accompanying the appliance.

WARNING: TO REDUCE THE RISK OF FIRE OR ELECTRIC SHOCK, DO NOT EXPOSE THIS APPLIANCE TO RAIN OR MOISTURE.

CAUTION

TO PREVENT ELECTRIC SHOCK, MATCH WIDE BLADE OF PLUG TO WIDE SLOT, FULLY INSERT.

FCC INFORMATION (For US customers)

1. PRODUCT
 This product complies with Part 15 of the FCC Rules. Operation is subject to the following two conditions: (1) this product may not cause harmful interference, and (2) this product must accept any interference received, including interference that may cause undesired operation.

2. IMPORTANT NOTICE: DO NOT MODIFY THIS PRODUCT
 This product, when installed as indicated in the instructions contained in this manual, meets FCC requirements. Modification not expressly approved by DENON may void your authority, granted by the FCC, to use the product.

3. NOTE
 This product has been tested and found to comply with the limits for a Class B digital device, pursuant to Part 15 of the FCC Rules. These limits are designed to provide reasonable protection against harmful interference in a residential installation.
 This product generates, uses and can radiate radio frequency energy and, if not installed and used in accordance with the instructions, may cause harmful interference to radio communications. However, there is no guarantee that interference will not occur in a particular installation. If this product does cause harmful interference to radio or television reception, which can be determined by turning the product OFF and ON, the user is encouraged to try to correct the interference by one or more of the following measures:

- Reorient or relocate the receiving antenna.
- Increase the separation between the equipment and receiver.
- Connect the product into an outlet on a circuit different from that to which the receiver is connected.
- Consult the local retailer authorized to distribute this type of product or an experienced radio/TV technician for help.

ATTENTION

POUR ÉVITER LES CHOCS ÉLECTRIQUES, INTRODUIRE LA LAME LA PLUS LARGE DE LA FICHE DANS LA BORNE CORRESPONDANTE DE LA PRISE ET POUSSER JUSQU' AU FOND.

NOTE ON USE / OBSERVATIONS RELATIVES A L'UTILISATION

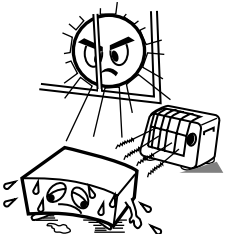
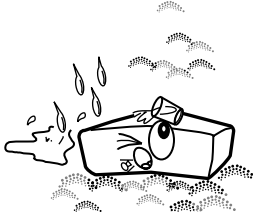
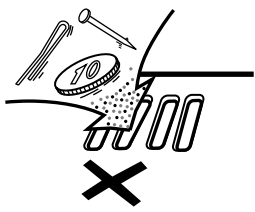
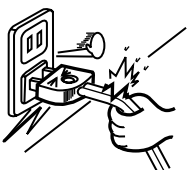
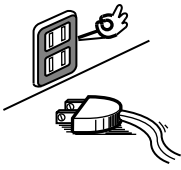
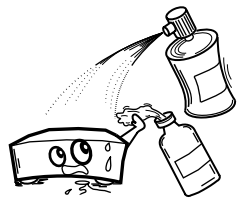
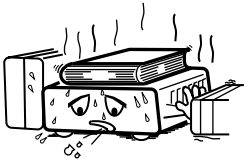
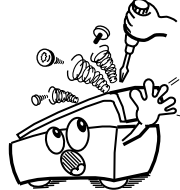
 <ul style="list-style-type: none"> • Avoid high temperatures. Allow for sufficient heat dispersion when installed on a rack. • Éviter des températures élevées. Tenir compte d'une dispersion de chaleur suffisante lors de l'installation sur une étagère. 	 <ul style="list-style-type: none"> • Keep the set free from moisture, water, and dust. • Protéger l'appareil contre l'humidité, l'eau et la poussière. 	 <ul style="list-style-type: none"> • Do not let foreign objects in the set. • Ne pas laisser des objets étrangers dans l'appareil.
 <ul style="list-style-type: none"> • Handle the power cord carefully. Hold the plug when unplugging the cord. • Manipuler le cordon d'alimentation avec précaution. Tenir la prise lors du débranchement du cordon. 	 <ul style="list-style-type: none"> • Unplug the power cord when not using the set for long periods of time. • Débrancher le cordon d'alimentation lorsque l'appareil n'est pas utilisé pendant de longues périodes. 	 <ul style="list-style-type: none"> • Do not let insecticides, benzene, and thinner come in contact with the set. • Ne pas mettre en contact des insecticides, du benzène et un diluant avec l'appareil.
<ul style="list-style-type: none"> • Handle the power cord carefully. Hold the plug when unplugging the cord. • Manipuler le cordon d'alimentation avec précaution. Tenir la prise lors du débranchement du cordon. 	 <p>* (For sets with ventilation holes)</p> <ul style="list-style-type: none"> • Do not obstruct the ventilation holes. • Ne pas obstruer les trous d'aération. 	 <ul style="list-style-type: none"> • Never disassemble or modify the set in any way. • Ne jamais démonter ou modifier l'appareil d'une manière ou d'une autre.

SAFETY INSTRUCTIONS

1. Read Instructions – All the safety and operating instructions should be read before the product is operated.
2. Retain Instructions – The safety and operating instructions should be retained for future reference.
3. Heed Warnings – All warnings on the product and in the operating instructions should be adhered to.
4. Follow Instructions – All operating and use instructions should be followed.
5. Cleaning – Unplug this product from the wall outlet before cleaning. Do not use liquid cleaners or aerosol cleaners.
6. Attachments – Do not use attachments not recommended by the product manufacturer as they may cause hazards.
7. Water and Moisture – Do not use this product near water – for example, near a bath tub, wash bowl, kitchen sink, or laundry tub; in a wet basement; or near a swimming pool; and the like.
8. Accessories – Do not place this product on an unstable cart, stand, tripod, bracket, or table. The product may fall, causing serious injury to a child or adult, and serious damage to the product. Use only with a cart, stand, tripod, bracket, or table recommended by the manufacturer, or sold with the product. Any mounting of the product should follow the manufacturer's instructions, and should use a mounting accessory recommended by the manufacturer.
9. A product and cart combination should be moved with care. Quick stops, excessive force, and uneven surfaces may cause the product and cart combination to overturn.
10. Ventilation – Slots and openings in the cabinet are provided for ventilation and to ensure reliable operation of the product and to protect it from overheating, and these openings must not be blocked or covered. The openings should never be blocked by placing the product on a bed, sofa, rug, or other similar surface. This product should not be placed in a built-in installation such as a bookcase or rack unless proper ventilation is provided or the manufacturer's instructions have been adhered to.
11. Power Sources – This product should be operated only from the type of power source indicated on the marking label. If you are not sure of the type of power supply to your home, consult your product dealer or local power company. For products intended to operate from battery power, or other sources, refer to the operating instructions.
12. Grounding or Polarization – This product may be equipped with a polarized alternating-current line plug (a plug having one blade wider than the other). This plug will fit into the power outlet only one way. This is a safety feature. If you are unable to insert the plug fully into the outlet, try reversing the plug. If the plug should still fail to fit, contact your electrician to replace your obsolete outlet. Do not defeat the safety purpose of the polarized plug.



13. Power-Cord Protection – Power-supply cords should be routed so that they are not likely to be walked on or pinched by items placed upon or against them, paying particular attention to cords at plugs, convenience receptacles, and the point where they exit from the product.
15. Outdoor Antenna Grounding – If an outside antenna or cable system is connected to the product, be sure the antenna or cable system is grounded so as to provide some protection against voltage surges and built-up static charges. Article 810 of the National Electrical Code, ANSI/NFPA 70, provides information with regard to proper grounding of the mast and supporting structure, grounding of the lead-in wire to an antenna discharge unit, size of grounding conductors, location of antenna-discharge unit, connection to grounding electrodes, and requirements for the grounding electrode. See Figure A.
16. Lightning – For added protection for this product during a lightning storm, or when it is left unattended and unused for long periods of time, unplug it from the wall outlet and disconnect the antenna or cable system. This will prevent damage to the product due to lightning and power-line surges.
17. Power Lines – An outside antenna system should not be located in the vicinity of overhead power lines or other electric light or power circuits, or where it can fall into such power lines or circuits. When installing an outside antenna system, extreme care should be taken to keep from touching such power lines or circuits as contact with them might be fatal.
18. Overloading – Do not overload wall outlets, extension cords, or integral convenience receptacles as this can result in a risk of fire or electric shock.
19. Object and Liquid Entry – Never push objects of any kind into this product through openings as they may touch dangerous voltage points or short-out parts that could result in a fire or electric shock. Never spill liquid of any kind on the product.
20. Servicing – Do not attempt to service this product yourself as opening or removing covers may expose you to dangerous voltage or other hazards. Refer all servicing to qualified service personnel.
21. Damage Requiring Service – Unplug this product from the wall outlet and refer servicing to qualified service personnel under the following conditions:
 - a) When the power-supply cord or plug is damaged,
 - b) If liquid has been spilled, or objects have fallen into the product,
 - c) If the product has been exposed to rain or water,
 - d) If the product does not operate normally by following the operating instructions. Adjust only those controls that are covered by the operating instructions as an improper adjustment of other controls may result in damage and will often require extensive work by a qualified technician to restore the product to its normal operation,
 - e) If the product has been dropped or damaged in any way, and
 - f) When the product exhibits a distinct change in performance – this indicates a need for service.
22. Replacement Parts – When replacement parts are required, be sure the service technician has used replacement parts specified by the manufacturer or have the same characteristics as the original part. Unauthorized substitutions may result in fire, electric shock, or other hazards.
23. Safety Check – Upon completion of any service or repairs to this product, ask the service technician to perform safety checks to determine that the product is in proper operating condition.
24. Wall or Ceiling Mounting – The product should be mounted to a wall or ceiling only as recommended by the manufacturer.
25. Heat – The product should be situated away from heat sources such as radiators, heat registers, stoves, or other products (including amplifiers) that produce heat.

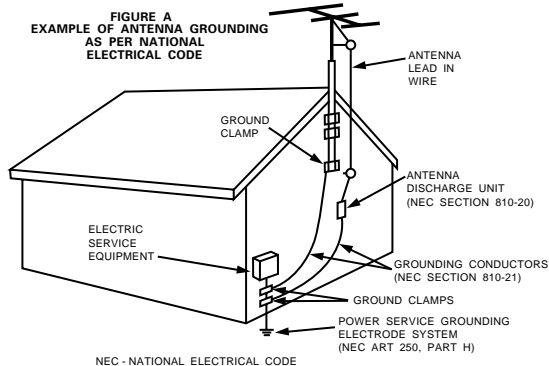

■ INTRODUCTION

Thank you for choosing the DENON AVR-5805 Digital Surround A / V receiver. This remarkable component has been engineered to provide superb surround sound listening with home theater sources such as DVD, as well as providing outstanding high fidelity reproduction of your favorite music sources.

As this product is provided with an immense array of features, we recommend that before you begin hookup and operation that you review the contents of this manual before proceeding.

TABLE OF CONTENTS

1	Before Using	6	2-7. Setting the THX Audio Setup	
2	Cautions on Installation	6	[1] Setting for using a THX Ultra2 compatible	
3	Cautions on Handling	7	subwoofer	56
4	Features	7~9	[2] Surround Back Speaker Position Settings.....	57
5	Connections	9	[3] Audio Input Setup	58
	Connecting Audio Components.....	10	3-1. Setting the Digital In Assignment	58, 59
	Connecting Video Components.....	11	3-2. Setting the EXT.IN Setup.....	60, 61
	Connecting video components equipped with S-Video		3-3. Setting the Input Function Level	62
	jacks.....	12	3-4. Setting the Function Rename	63, 64
	Connecting video components equipped with Component		3-5. Setting the IEEE1394 Assign	65
	Video video jacks	13	3-6. Selecting the IEEE1394 Auto Function	66
	Video Conversion Function.....	13, 14	3-7. Tuner Presets	
	Connecting equipment with HDMI terminals.....	14	[1] Auto Preset Memory.....	67
	Connecting equipment with DVI terminals	15	[2] Preset Skip	68
	Connecting the antenna terminals.....	16	[3] Preset Name	69, 70
	Connecting the external input (EXT.IN) jacks	16	[4] Video Setup	71
	Connecting the ZONE2 jacks.....	17	4-1. Setting the Component In Assign	71, 72
	Connecting a component with video and audio jacks to		4-2. Setting the Video Convert Mode.....	72, 73
	the V.AUX input jacks	17	4-3. Setting the Video Scaler	73, 74
	DENON LINK connections.....	18	4-4. Setting the 3D Y/C Separation.....	74
	Connecting IEEE1394 devices.....	19	4-5. Setting the HDMI/DVI In Assign	75, 76
	Speaker system connections.....	20, 21	4-6. Setting the Audio Delay.....	76, 77
6	Part Names and Functions		4-7. Setting the On Screen Display (OSD)	77, 78
	Front panel.....	22, 23	[5] Advanced Playback	78
	Display	24	5-1. Setting the 2ch Direct/Stereo.....	79
	Remote control unit.....	25	Setting the front B speakers when the surround	
7	System Setup	26	mode is set to the 2-channel Direct or Stereo.....	79
	System setup items and default values.....	26~28	5-2. Setting the Dolby Digital Setup	80
	Speaker system layout	29	5-3. Setting Auto Surround Mode	81
	Before setting up the system.....	30	5-4. Setting the Manual EQ Setup	82, 83
	Auto Setup / Room EQ.....	30	Procedure for copying the "Flat" correction curve.....	84
	Measurement flow	31	[6] Zone Setup (Zone2 = 5.1/7.1ch)	85
	Before performing the Auto Setup procedure	32	6-1. Setting the type of speakers for Zone2.....	86
	(I) Connecting the microphone for Auto Setup	32	6-2. Setting the low frequency distribution for Zone2.....	87
[1] Auto Setup / Room EQ		33	6-3. Setting the Delay Time for Zone2	88, 89
1-1. Setting the Auto Setup.....		33	6-4. Setting the Channel Level for Zone2	90, 91
(II) Extra Setup.....		34	6-5. Setting the Crossover Frequency for Zone2	92
(III) Preliminary measurements.....		35	6-6. Setting the Video Setup for Zone2	
(IV) Speaker System measurement.....		36, 37	[1] Video Convert Mode	93, 94
(V) Check of the measurement result		38, 39	[2] Audio Delay	94
About the error message		39	6-7. Zone3 and Zone4 tone control and channel level	
1-2. Setting the Room EQ Setup.....		40, 41	setting.....	95, 96
1-3. Setting the Direct Mode.....		41	Zone Setup setting when Zone2 is set to STEREO or	
1-4. Setting the MIC Input Select.....		42	MONO	96
Specifications and setup procedure			[7] Option Setup	97
for Non-DENON microphone		42, 43	7-1. Setting the Channel Setup	97
1-5. Check the Parameter		43~46	Channel setup flow	97, 98
[2] Speaker Setup		46	The number of channels that can be selected	99
2-1. Setting the type of speakers		46, 47	The subwoofer output composition.....	99
2-2. Setting the low frequency distribution		48	Connecting the preouts.....	100
2-3. Setting the Delay Time		49, 50	7-2. Setting the Power Amplifier Assignment.....	101
2-4. Setting the Channel Level.....		51, 52	Power amplifier assignment flow	101, 102
2-5. Setting the Crossover Frequency.....		53	Amp Assign mode.....	103
Setting the crossover frequency individually			Bi-Amp connection.....	103
for the different channels.....		54	Table of power amplifier assignment modes	103~105
2-6. Selecting the Surround Speakers for the			Table of channels to which power amplifiers can	
different surround modes.....		55	be assigned	105

7-3. Setting the Volume Control	106, 107
7-4. Setting the Trigger Out.....	107, 108
7-5. Setting the AC Outlet Assign	109, 110
7-6. Protecting the setting and memory backup	
[1] User Memory.....	110, 111
[2] Setup Lock.....	111, 112
After Completing system setup	112
8 Remote Control Unit	
Inserting the Batteries	113
Using the Remote Control Unit	113
Operating DENON audio components	114, 115
Preset memory	116
Operating a component stored in the preset memory ..	117, 118
Learning function.....	119
System call	120, 121
Punch Through	121
Setting the back light's lighting time	122
Setting the brightness	122
Resetting	123, 124
9 Operation	
Operating the Remote control unit.....	125
Before operating.....	125
Playing the input source	126, 127
Playback using external input (EXT.IN) jacks	128
Playing audio sources (CDs and DVDs).....	129
After stating playback	
[1] Setting the Room EQ.....	130
[2] Listening over headphone.....	130
[3] Turning the sound off temporarily (MUTING).....	130
[4] Combining the currently playing sound with the desired image (VIDEO SELECT)	130
[5] Checking the currently playing program source, etc.	131
[6] Switching the surround speakers	131
[7] Switching between HDMI and DVI monitor output.....	131
[8] Selection of resolution setting (SCALE)	132
Multi-source recording/playback	
[1] Playing one source while recording another (REC OUT mode).....	132
[2] Recording Dolby Digital and DTS multichannel sources.....	133
[3] Dolby Headphone recording.....	133
10 Surround	
Adjustment steps that need to be performed prior to surround sound playback	
[1] Test Tone.....	134
[2] Channel Level.....	134, 135
Fader function.....	135
Playing modes for different sources	136
THX Surround EX / Home THX Cinema mode	
[1] Playing sources recorded in Dolby Surround in the Home THX Cinema surround mode.....	137, 138
[2] To play in the THX Surround EX/Home THX Cinema Surround mode for sources recorded in Dolby Digital or DTS	139
Dolby Digital mode and DTS Surround.....	140, 141
Dolby Pro Logic IIx (Dolby Pro Logic II) mode.....	142, 143
DTS NEO:6 mode	144, 145
The Dolby Headphone	145, 146
Memory and call-out functions (USER MODE function)	146
11 DENON Original Surround Modes	
Surround modes and their features.....	147
DSP surround simulation	148, 149
Tone control setting	
[1] Adjusting the tone using the Remote control unit	149, 150
[2] Adjusting the tone from the Main unit.....	150
12 Multi Zone	
Multi-zone playback with multi-source	151
[1] ZONE2 playback	152~154
[2] ZONE3 playback.....	155
[3] ZONE4 playback.....	156
[4] Outputting a program source to amplifier, etc., in a Zone2 room (ZONE2 SELECT mode).....	157
[5] Outputting a program source to amplifier, etc., in a Zone3 or Zone4 room (ZONE3, ZONE4 SELECT mode).....	157
Remote control unit operations during multi-source playback	158
System Setup for multi-zone.....	159
Adjustment steps that need to be performed prior to surround sound playback in Zone2	
[1] Test Tone.....	159
[2] Channel Level.....	160
Fader function.....	161
Zone2 Surround	162
Memory and call-out functions of Zone2 (USER MODE function)	163
Zone2 tone control setting	164, 165
13 Listening to the Radio	
Auto tuning	165
Manual tuning.....	166
Preset memory.....	167
Checking the preset stations.....	168
Recalling preset stations	168
RDS (Radio Data System).....	169
RDS search.....	170
PTY search.....	171
TP search.....	172
RT (Radio Text).....	173
14 Last Function Memory	173
15 Initialization of the Microprocessor	173
16 Troubleshooting	174
17 Additional Information	
Optimum surround sound for different sources.....	175
Surround back speakers	176
Speaker setting examples	
[1] For THX Surround EX systems (using surround back speakers)	177, 178
[2] When not using surround back speakers	178
Surround	
[1] Dolby Surround	179, 180
[2] DTS Digital Surround.....	180, 181
[3] DTS-ES Extended Surround™.....	181
[4] DTS 96/24	182
[5] Home THX Cinema Surround.....	182, 183
[6] THX Surround EX	183
Audyssey MultEQ XT	184
HDCD.....	184
DENON LINK	185
About IEEE1394	185
About HDMI.....	185
Advanced AL24 Processing.....	185
Surround modes and parameters.....	186, 187
Relationship between the video input signal and monitor output (MAIN ZONE).....	188
Relationship between the video input signal and monitor output (ZONE2)	189
18 Specifications	190, 191

■ ACCESSORIES

Check that the following parts are included in addition to the main unit:

① Operating instructions	1	⑥ R03/AAA alkaline batteries	4
② Warranty (for North America model only).....	1	⑦ AM loop antenna	1
③ Service station list.....	1	⑧ FM indoor antenna.....	1
④ AC cord.....	1	⑨ List of preset codes.....	1
⑤ Remote control unit (RC-995).....	1		

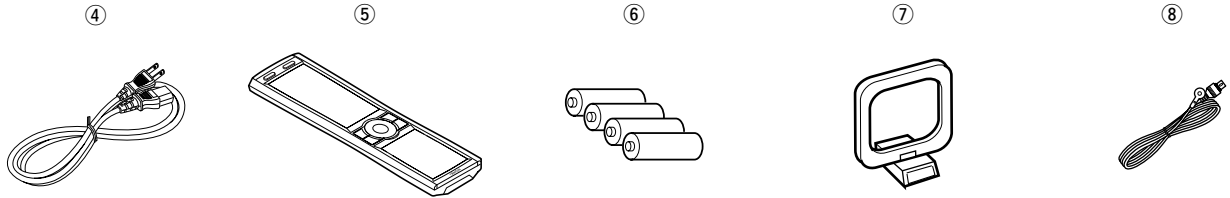

1 BEFORE USING

Pay attention to the following before using this unit:

• Moving the set

To prevent short circuits or damaged wires in the connection cords, always unplug the power cord and disconnect the connection cords between all other audio components when moving the set.

• Before turning the power switch on

Check once again that all connections are proper and that there are not problems with the connection cords. Always set the power switch to the standby position before connecting and disconnecting connection cords.

• Store these instructions in a safe place.

After reading, store these instructions along with the warranty in a safe place.

• Note that the illustrations in these instructions may differ from the actual set for explanation purposes.

2 CAUTIONS ON INSTALLATION

Noise or disturbance of the picture may be generated if this unit or any other electronic equipment using microprocessors is used near a tuner or TV.

If this happens, take the following steps:

- Install this unit as far as possible from the tuner or TV.
- Set the antenna wires from the tuner or TV away from this unit's power cord and input/output connection cords.
- Noise or disturbance tends to occur particularly when using indoor antennas or 300 Ω /ohms feeder wires. **We recommend using outdoor antennas and 75 Ω /ohms coaxial cables.**

For heat dispersal, leave at least 10 cm of space between the top, back and sides of this unit and the wall or other components.

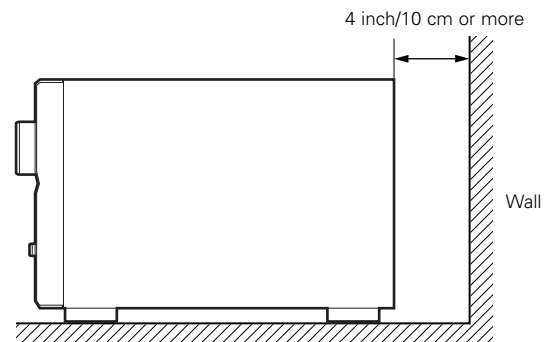
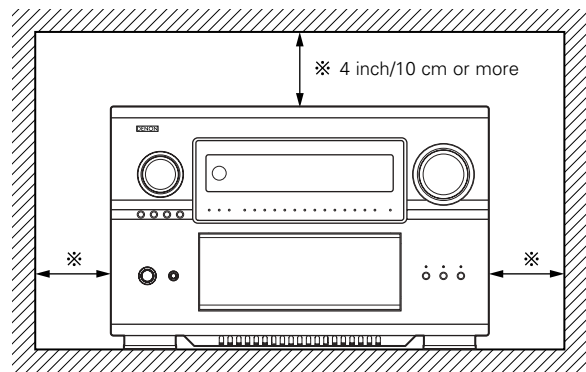

3 CAUTIONS ON HANDLING

- **Switching the input function when input jacks are not connected**

A clicking noise may be produced if the input function is switched when nothing is connected to the input jacks. If this happens, either turn down the MASTER VOLUME control or connect components to the input jacks.

- **Muting of PRE OUT jacks and SPEAKER terminals**

The PRE OUT jacks and SPEAKER terminals include a muting circuit. Because of this, the output signals are greatly reduced for several seconds after the power switch is turned on or input function, surround mode or any other-set-up is changed. If the volume is turned up during this time, the output will be very high after the muting circuit stops functioning. Always wait until the muting circuit turns off before adjusting the volume.

- **Whenever the power switch is in the STANDBY state, the apparatus is still connected on AC line voltage. Please be sure to turn off the power switch or unplug the cord when you leave home for, say, a vacation.**

4 FEATURES

1. DENON Proprietary Digital Technology

- 1) NEW D.D.S.C.-Digital (Dynamic Discrete Surround Circuit)
Powered by four high performance, high speed 32 bit floating point DSP processors, the AVR-5805 represents the pinnacle of precision DSP processing technology. Unlike competitive units, DENON's discrete surround technology consists of selected individual processors and ancillary elements, working in harmony via proprietary DENON inter-IC digital communication technology.
- 2) DENON Link
With select DENON DVD players that feature DENON Link digital outputs, encrypted digital multi-channel audio transfers to the AVR-5805 directly, eliminating unnecessary digital-to-analog and subsequent analog-to-digital conversions for the highest possible signal transfer integrity. The DENON Link function supports up to ultra high resolution 192 kHz DVD-A digital datastreams, for maximum reproduced fidelity.
- 3) Latest AL24 DSP Processing
DENON's acclaimed Advanced AL24 DSP processing improves the fidelity of high resolution stereo PCM sources such as CD and DVD (up to 192 kHz sampling frequencies), by sophisticated DSP processing algorithms that improve low level detail and enhance fidelity by upsampling and adaptive filtering techniques. Advanced AL24 provides increased dynamic range and spatial information; bring out all the nuances with optimum clarity and natural fidelity.
- 4) AL24 DSP Processing For All Channels
For the AVR-5805, DENON's AL24 processing supports multi-channel DVD-Audio for all channels, including the Zone2 multi-channel theater channels, for optimum fidelity and low level detail reproduction in both the main zone as well as the second multi-channel Zone2 system.

2. Latest Surround Decoding Technology

- 1) Dolby Digital
Using advanced digital audio compression and decoding technologies, Dolby Digital provides up to 5.1 channels of wide bandwidth, wide dynamic range multi-channel high fidelity surround sound. Dolby Digital is the default digital multi-channel audio delivery system for DVD and USA/Canada high definition television systems.
- 2) Dolby Pro Logic IIx
Dolby Pro Logic IIx adds the ability to provide up to 7.1 channel reproduction from conventional stereo (2 channel) sources, including surround back reproduction with a 6.1 or 7.1 surround sound system. Pro Logic IIx has three modes: one for movie-based soundtracks; one for stereo music sources, and a game mode for game consoles with stereo (2 channel) audio outputs.

- 3) Dolby Headphone

Developed jointly by Dolby Laboratories and Lake Technology Ltd. of Australia, Dolby Headphone decoding provides thrilling surround sound effects of your favorite movie and music sources when using conventional stereo headphones.

- 4) DTS (Digital Theater Systems)

DTS provides up to 5.1 channels of wide-range, high fidelity surround sound from sources such as DTS-encoded CDs, DVDs with DTS soundtracks, and DVD-Audio discs that provide DTS soundtracks.

- 5) DTS-ES Extended Surround and DTS Neo:6

The AVR-5805 also supports the DTS-ES 6.1 matrix and discrete encoded surround formats, and also features DTS Neo:6 stereo-to-surround decoding with both Music and Movie modes for superb surround sound from conventional stereo sources.

- 6) DTS 96/24 Decoding

Digital Theater Systems 96/24 provides ultra high resolution 24 bit, 96 kHz sampling for optimum wide bandwidth fidelity and superb dynamic range. The AVR-5805 is equipped to faithfully decode DTS 96/24 discs.

- 7) HDCD High Definition Compatible Digital

Using sophisticated encoding and decoding technologies, the HDCD format provides improved fidelity and dynamic range from encoded Compact Discs (which number in the thousands of titles). The AVR-5805, via a standard digital audio connection from a CD player or DVD player, internally recognizes and decodes HDCD discs for optimum fidelity and widest dynamic range.

- 8) Home THX Ultra2 Certified

Home THX is the unique collaboration between THX Ltd. and audio/video equipment manufacturers. THX Ultra2 certification is the highest performance level, and provides a rigorous set of performance standards along with proprietary surround sound post-processing technologies, all designed to maximize the surround soundtrack playback experience in the home theater. In addition, the AVR-5805 is fully compatible with THX Surround EX, which provides extended surround sound via additional surround back channel reproduction, first employed on Lucasfilms' Star Wars Episode 1 – The Phantom Menace, and featured on many major motion pictures since. As well, the AVR-5805's power amplifier section fully complies with the latest THX Ultra2 standards, and two new addition surround modes are also provided – THX Ultra2 Cinema mode and THX Music mode. In addition, the AVR-5805 also incorporates THX's new THX Games mode, for thrilling surround sound effects from two channel game box audio sources.

3. Movie & Music Surround For The Whole House

The AVR-5805's versatile Multi Source functions let you select different audio and video sources for each room in your home. Different audio and video multi-channel sources can be enjoyed in the home theater (Main room), as well as a multi-channel audio and video source directed to a second room. Additional zones (3 and 4) can also receive video and stereo audio as well. The AVR-5805 features Freely Assignable Ten Power Amp Channels, so that you can decide which power amp channels can be dedicated to the main zone, the secondary zone (Zone2) as well as to two additional zones (Zone3 and Zone4), as well as providing line level outputs to external power amplifiers.

1) Zone2 Theater Capability

With up to 9.1 system in the main home theater room, the AVR-5805 provides for a second, fully 5.1 capable system in Zone2, with component video and five amplifier channels as well, with video up-conversion if desired.

2) Zone3 Independent Audio & Video

The AVR-5805 provides the ability for a third independent zone, with selectable audio and video sources.

3) Zone4 Independent Audio

Zone4 is ideal for a room where you can enjoy a different stereo source, for background music listening.

4. Ten High Power Assignable Power Amplifiers

1) Featuring high current, THX-certified high power amplifier channels, the AVR-5805 is equipped to drive high performance loudspeakers with unprecedented dynamic range and low impedance drive capability, with each of the ten amplifier channels rated at 170 W into 8 Ω /ohms. Each channel can be freely assigned to the main home theater room, as well as assigned to additional zones for multi-channel or stereo or even monophonic distributed audio/video and audio-only functions. For example, you might choose to have seven amplifier channels dedicated to a full THX Surround EX & DTS Surround EX 7.1 channel system in the main room, while still allowing a powered stereo function in the second zone, and a third monophonic background music function in another room. Or, you could have a principal 5.1 channel setup in the main home theater room, while having a secondary powered 5.1 system in the second zone. You could even have (with compatible bi-amplified-capable speakers) a true 5.1 bi-amped system in the main room, along with additional line-level-powered systems in up to three additional rooms.

5. Audiophile Audio Quality Throughout

1) Separated Pure Audio & Video Chassis Construction

For optimum audio and video quality, the AVR-5805 features dedicated and physically separated low and high level audio and video circuits to prevent degrading mutual interference.

2) Optimum Chassis Stability

As the AVR-5805 is equipped with a massive toroidal main power supply and additional secondary power supplies, centrally located within the chassis, a fifth chassis foot helps reduce the physical vibration that can cause mechanically-induced vibration-related distortions.

3) Multiple Separate Power Supply Topologies

No less than six individual power transformers (one very large toroidal unit, and five additional lower voltage power transformer units) are provided, ensuring that each critical subsection draws power from its own dedicated supply, eliminating minute fluctuations that occur with single transformer-equipped competitive units.

4) Multiple Toroidal Sub-Windings

The massive main toroidal power transformer (which powers the ten amplifier channels block) features dedicated sub-windings and high current, ultra stable DC rectifiers and high rated smoothing/storage capacitors, with a tremendous 132,000 μ F total storage capacity.

5) Pure Direct Mode

According to the selected input source, the Pure Direct Mode provides the optimum decoding by switching off any and all unnecessary processing (video disable, tone bypass, and other unnecessary circuits).

6) Dual Surround Speaker Mode

DENON was the first to introduce Dual Surround Mode Speaker Switching, where two different types (and positions) of surround speakers could be chosen according to the source material – diffuse surround speakers located at the sides of the listening position for movie surround sound, and directional surround speakers located at the room's rear corners for music surround sound. The AVR-5805 also adds the ability to have both powered (AVR-5805 amplified) music and surround sound speaker systems, according to each individual home theater's setup circumstances.

7) Highest Quality Input & Output Terminals

The AVR-5805 audio and video input terminals are gold-plated, as are the ten speaker terminal pairs, which accept bare wire as well as banana plugs.

6. High Resolution Video Section

1) Component Video Switching

In addition to composite and S-video switching, the AVR-5805 provides no less than five sets of component video inputs via RCA-type coaxial connectors, as well as an additional sixth set of component video inputs via BNC connectors, as well as two sets of component video outputs (one for RCA-type coaxial, one for BNC connectors), with additional capability for component video output to Zone2. These component video circuits are fully HD-compatible, with a flat response to 100 MHz, far above the 38 MHz requirement for true HD reproduction, ensuring crisp and clear HDTV picture quality.

2) Video Up And Down Conversion Function

To eliminate video signal incompatibility, the AVR-5805 is equipped with video up-conversion and down-conversion. Composite and S-video signals are internally up-converted to component video for the main zone, and down-converted for 480i component video signals. Zone2 features down-conversion from S-video to composite video.

3) Progressive Scanning & Scaling Function

Via high quality Faroudja DCDi™ (*1) processing, the AVR-5805 converts standard definition interlaced video to higher resolution progressive scanning format – 480i interlace to 480p progressive. For non-copy-protected video signals, further up-conversion to HD 1080i video is also provided, for highest visual quality with compatible HD video displays.

4) High Resolution 12 bit/216 MHz Video D/A Conversion

Featuring Analog Devices ADV-7310 Noise Shaped Video (*2) digital-to-analog converters, the AVR-5805 provides superior high resolution video output free from video noise and conversion artifacts.

5) Superior S-video Processing

A 3-dimensional Y-C separation circuit provides artifact-free composite video to S-video up-conversion, and Time Base Correction for optimum color sharpness with composite video inputs (main zone).

7. Latest Digital A/V Input/Output Capability With Future Upgrade Ability

1) HDMI/DVI Switching

High Definition Multi-media Interface provides digital audio and video signal transfer between source components, the AVR-5805, and compatible video displays with HDMI digital interface. Digital Visual Interface provides similar digital input/output capability for digital video signals. The AVR-5805 is equipped with three HDMI inputs and one DVI input, and one each HDMI and DVI outputs to compatible video displays. Each HDMI/DVI input feeds both HDMI and DVI outputs, for optimum compatibility with today's HDMI- and DVI-equipped video displays.

- 2) IEEE 1394 Compatibility
Two IEEE 1394 digital interface inputs are provided, allowing SACD DSD and DVD-Audio digital audio signal input capability with select DENON DVD players that feature IEEE 1394 digital output function, and feature DENON's D.A.S.S. (DENON Audio Synchronized System) function, which reduces data jitter for superior high resolution DSD and PCM reproduction.
- 3) Ethernet Function
For full compatibility with external control systems, such as AMX and Crestron, the AVR-5805 features Ethernet connectivity.
- 4) RS-232C Serial Input/Output Function
For full compatibility with external control systems, such as AMX and Crestron, the AVR-5805 features a RS-232C serial I/O port. A second RS-232C serial I/O port is provided on the front panel, for future software and system upgrade capability.
- 5) Future Surround Format Inputs & Outputs
For possible future surround sound formats, the AVR-5805 features up to ten channel audio inputs (nine main channels plus an additional low frequency effects channel), with high resolution A/D conversion on each input. A second set of 5.1 analog inputs is also provided, for connection to surround sources such as SACD and/or DVD-Audio players.
- 7) Assignable High Current Trigger Outputs
Four different 12 Volt trigger outputs allow the automatic activation of externally controlled devices, such as motorized drop-down screens, motorized drapery, motorized screen masking systems and other trigger-activated systems. Each port supports 12V/250mA trigger-activated functions, assignable by zone (Main Zone, Zone2, Zone3, or Zone4).
- 8) Assignable AC Outlets
Three assignable AC convenience outlets are provided, and each can be activated by choice of input source or surround sound mode by each zone, to activate specific external components as necessary.
- 9) Front Panel Convenience Inputs
A set of front panel A/V inputs allows quick connection of A/V sources, such as a video camcorder or a game console.
- 10) Electro-Luminescent Membrane Touch-Panel Remote Control
Featuring back-lit EL technology, the AVR-5805 remote control displays a specific function key set for each selected component, and is pre-programmed with hundreds of remote control code sets and features learning capability as well.
- 11) Large Fluorescent Display
For easy setup and system monitoring, the AVR-5805 features a clearly readable FL display that provides extensive system status and setup monitoring.

8. Easy-To-Use Functions

- 1) Automatic Setup With Room Equalization
Featuring the newest Audyssey MultEQ XT technology, the AVR-5805 provides automatic room equalization with multiple measurement points for optimum response throughout the listening room.
- 2) Three User-Definable Easy Modes
Three User Modes are provided, allowing you to store and recall your favorite surround modes with individual level memories at the touch of a button.
- 3) Digital Audio Delay Function
For optimum picture and sound synchronization, the AVR-5805 features an adjustable digital audio delay function, variable from 0 ~ 200 milli-seconds.
- 4) Adjustable Crossover Frequencies
For the widest compatibility with various main speaker and subwoofer combinations, the AVR-5805 is equipped with a choice of ten different crossover frequencies (40, 60, 80, 90, 100, 110, 120, 150, 200 and 250 Hz crossover points), individually adjustable for each of the main speaker systems.
- 5) The AVR-5805 provides dual subwoofer outputs, along with an additional subwoofer output dedicated for the Low Frequency Effects channel (main zone).
- 6) Auto Surround Mode
For each input source, a separate memory stores your preferred surround sound mode and other settings, eliminating the need to re-configure the surround mode parameters whenever you switch between input sources.
- 12) Preset Memory Tuning
Up to 56 AM and FM stations can be stored in the tuner memory, in any combination and in any order of AM and FM stations.
- 13) AC Input
Detachable AC Cord.
- 14) Other Useful Functions
Digital Audio Input to Analog Recording Output conversion
Input Source Re-naming Function
Audio Level Memories for each input
Personal Memory Plus function stores surround mode, level memories, analog or digital input selection for each input
Volume Level Limiter provides a user-definable pre-set volume level for multi-zone audio operation
Power On Volume Level Memory provides a user-definable volume level that is activated every time the AVR-5805 is powered up
Setup Lock Function prevents mis-operation at start-up
Personal Default Memory function
RDS tuner capability

*1: "DCDi™" is trademark of Faroodja, a division of Genesis Microchip Inc.

*2: "NSV" is a trademark of Analog Devices, Inc.

5 CONNECTIONS

- Do not plug in the AC cord until all connections have been completed.
- Be sure to connect the left and right channels properly (left with left, right with right).
- Insert the plugs securely. Incomplete connections will result in the generation of noise.
- **Use the AC OUTLETS for audio equipment only. Do not use them for hair driers, etc.**
- Note that binding pin plug cords together with AC cords or placing them near a power transformer will result in generating hum or other noise.
- Noise or humming may be generated if a connected audio equipment is used independently without turning the power of this unit on. If this happens, turn on the power of the this unit.

Connecting Audio Components

- When making connections, also refer to the operating instructions of the other components.

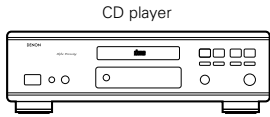

Connecting a CD player

Connect the CD player's analog output jacks (ANALOG OUTPUT) to this unit's CD jacks using pin plug cords.

Connecting a turntable

Connect the turntable's output cord to the AVR-5805's PHONO jacks, the L (left) plug to the L jack, the R (right) plug to the right jack.

NOTE:

This unit cannot be used with MC cartridges directly. Use a separate head amplifier or step-up transformer.



Turntable (MM cartridge)

If humming or other noise is generated when the ground wire is connected, disconnect the ground wire.

Ground wire

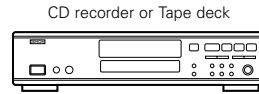

Connecting a tape deck

Connections for recording:

Connect the tape deck's recording input jacks (LINE IN or REC) to this unit's tape recording (OUT) jacks using pin plug cords.

Connections for playback:

Connect the tape deck's playback output jacks (LINE OUT or PB) to this unit's tape playback (IN) jacks using pin plug cords.

Connecting the pre-out jacks

Use these jacks if you wish to connect external power amplifier(s) to increase the power of the front, center, surround and surround back sound channels, or for connection to powered loudspeakers.

When using only one surround back speaker, connect it to left channel.

AC outlets (wall)

AC 120V, 60Hz

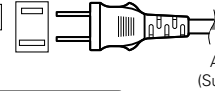

AC cord (Supplied)

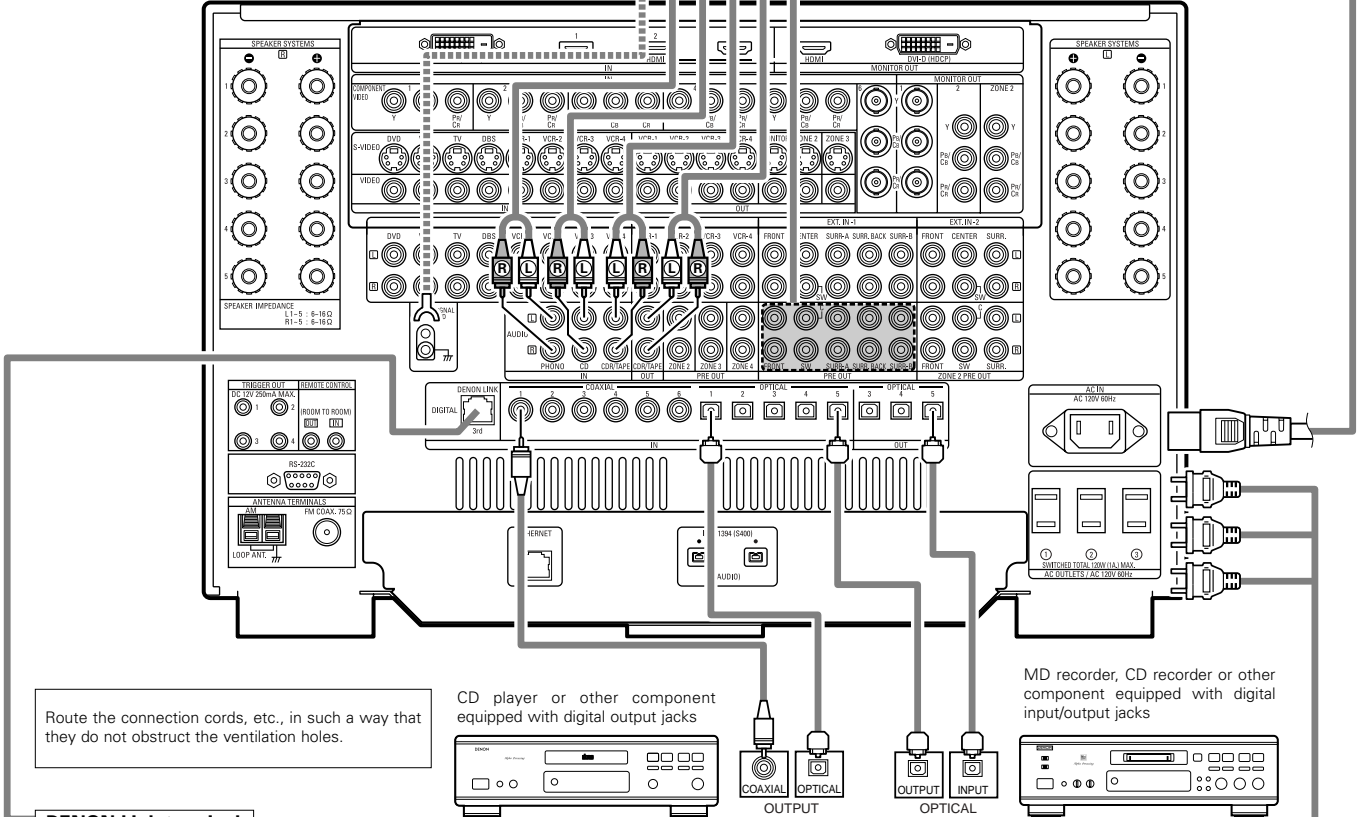

Route the connection cords, etc., in such a way that they do not obstruct the ventilation holes.

DENON Link terminal

Use this terminal to connect a DENON DVD player with high quality digital multichannel sound. (See page 18)

CD player or other component equipped with digital output jacks

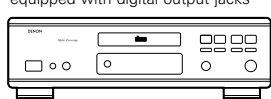

Connecting the DIGITAL jacks

Use these for connections to audio equipment with digital output. Only one type of connector needs to be used, you can decide which based on availability of coaxial and optical inputs. Refer to pages 58, 59 for instructions on setting this terminal.

MD recorder, CD recorder or other component equipped with digital input/output jacks

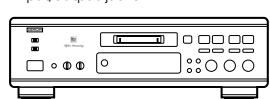

NOTES:

- Use 75 Ω/ohms cable pin cords for coaxial connections.
- Use optical cables for optical connections, removing the cap before connecting.

Connecting the AC OUTLETS

AC OUTLETS

- SWITCHED (total capacity – 120 W (1 A.))

The power to these outlets is turned on and off in conjunction with the POWER switch on the main unit, and when the power is switched between on and standby from the remote control unit.

No power is supplied from these outlets when this unit's power is at standby. Never connect equipment whose total capacity is above 120 W (1 A.)

NOTES:

- Only use the AC OUTLETS for audio equipment. Never use them for hair driers, TVs or other electrical appliances.
- The AC outlets can be set to turn on and off for the different functions. For details, see "Setting the AC Outlet Assign". (See pages 109, 110)

Connecting Video Components

- To connect the video signal, connect using a 75 Ω/ohms video signal cable cord. Using an improper cable can result in a drop in picture quality.
- When making connections, also refer to the operating instructions of the other components.
- The AVR-5805 is equipped with a function for up and down converting video signals. (See page 13)
The signal connected to the video signal terminal is output to the S-Video and component video monitor out terminals. But the REC OUT terminals have no conversion function, so when recording connect the appropriate video terminals.

DVD player or video disc player (VDP), etc.

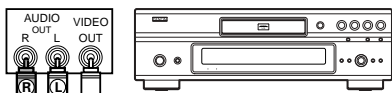

Connecting a DVD player or a video disc player (VDP)

DVD

- Connect the video disc player's video output jack (VIDEO OUTPUT) to the VIDEO (yellow) DVD IN jack using a 75 Ω/ohms video coaxial pin plug cord.
- Connect the video disc player's analog audio output jacks (ANALOG AUDIO OUTPUT) to the AUDIO DVD IN jacks using pin plug cords.
- VDP can be connected to the VDP jacks in the same way.

TV

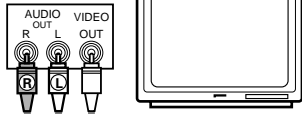

Connecting a TV tuner

TV

- Connect the TV's tuner's video output jack (VIDEO OUTPUT) to the VIDEO (yellow) TV IN jack using a 75 Ω/ohms video coaxial pin plug cord.
- Connect the TV's tuner's audio output jacks (AUDIO OUTPUT) to the AUDIO TV IN jacks using pin plug cords.

DBS tuner

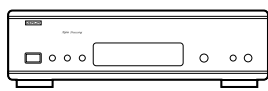

Connecting a DBS tuner

DBS

- Connect the DBS tuner's video output jack (VIDEO OUTPUT) to the VIDEO (yellow) DBS IN jack using a 75 Ω/ohms video coaxial pin plug cord.
- Connect the DBS tuner's audio output jacks (AUDIO OUTPUT) to the AUDIO DBS IN jacks using pin plug cords.

Monitor TV



Connecting a monitor TV

MONITOR OUT

- Connect the TV's video input jack (VIDEO INPUT) to the VIDEO MONITOR OUT jack using a 75 Ω/ohms video coaxial pin plug cord.

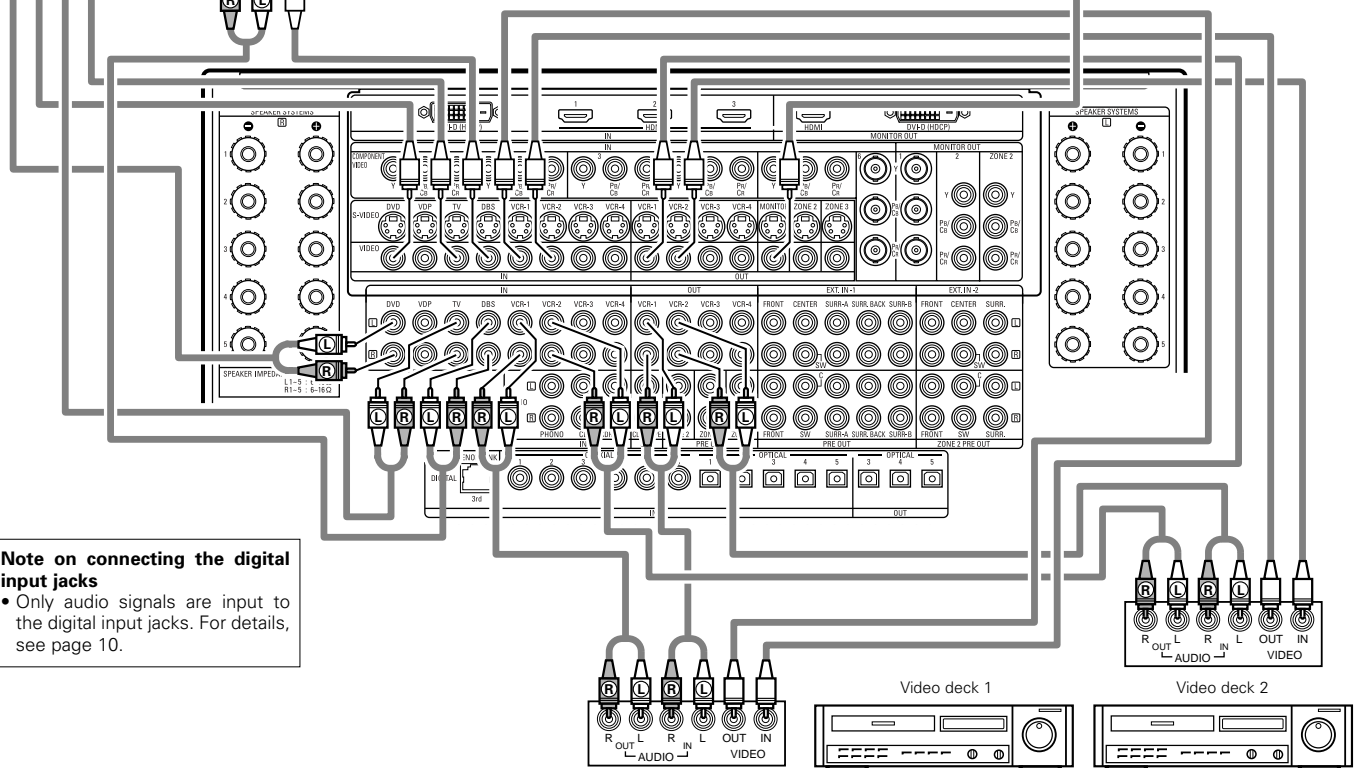

Note on connecting the digital input jacks

- Only audio signals are input to the digital input jacks. For details, see page 10.

NOTE:

Connecting a LD (laser disc) player with a Dolby Digital RF Output.

The AVR-5805 does not have a DD RF demodulator function. Therefore, you need to use a commercially available outboard DD RF demodulator and connect its digital output to one of the AVR-5805 available digital inputs. Refer to the demodulator's owner's manual for further information.

Connecting the video recorders

- There are four sets of video deck (VCR) jacks, so four video decks can be connected for simultaneous recording or video copying.

Video input/output connections:

- Connect the video deck's video output jack (VIDEO OUT) to the VIDEO (yellow) VCR-1 IN jack, and the video deck's video input jack (VIDEO IN) to the VIDEO (yellow) VCR-1 OUT jack using 75 Ω/ohms video coaxial pin plug cords.

Connecting the audio output jacks

- Connect the video deck's audio output jacks (AUDIO OUT) to the AUDIO VCR-1 IN jacks, and the video deck's audio input jacks (AUDIO IN) to the AUDIO VCR-1 OUT jacks using pin plug cords.

※ Connect other video decks to the VCR-2, VCR-3 or VCR-4 jacks in the same way.

Connecting video components equipped with S-Video jacks

- When making connections, also refer to the operating instructions of the other components.
- **A note on the S-Video input jacks**
The input selectors for the S-Video inputs and Video inputs work in conjunction with each other.
- The AVR-5805 is equipped with a function for converting video signals. (See page 13)
The signal connected to the S-Video signal terminal is output to the composite video and component video monitor out terminals. But the REC OUT terminals have no conversion function, so when recording connect the S-Video terminals.

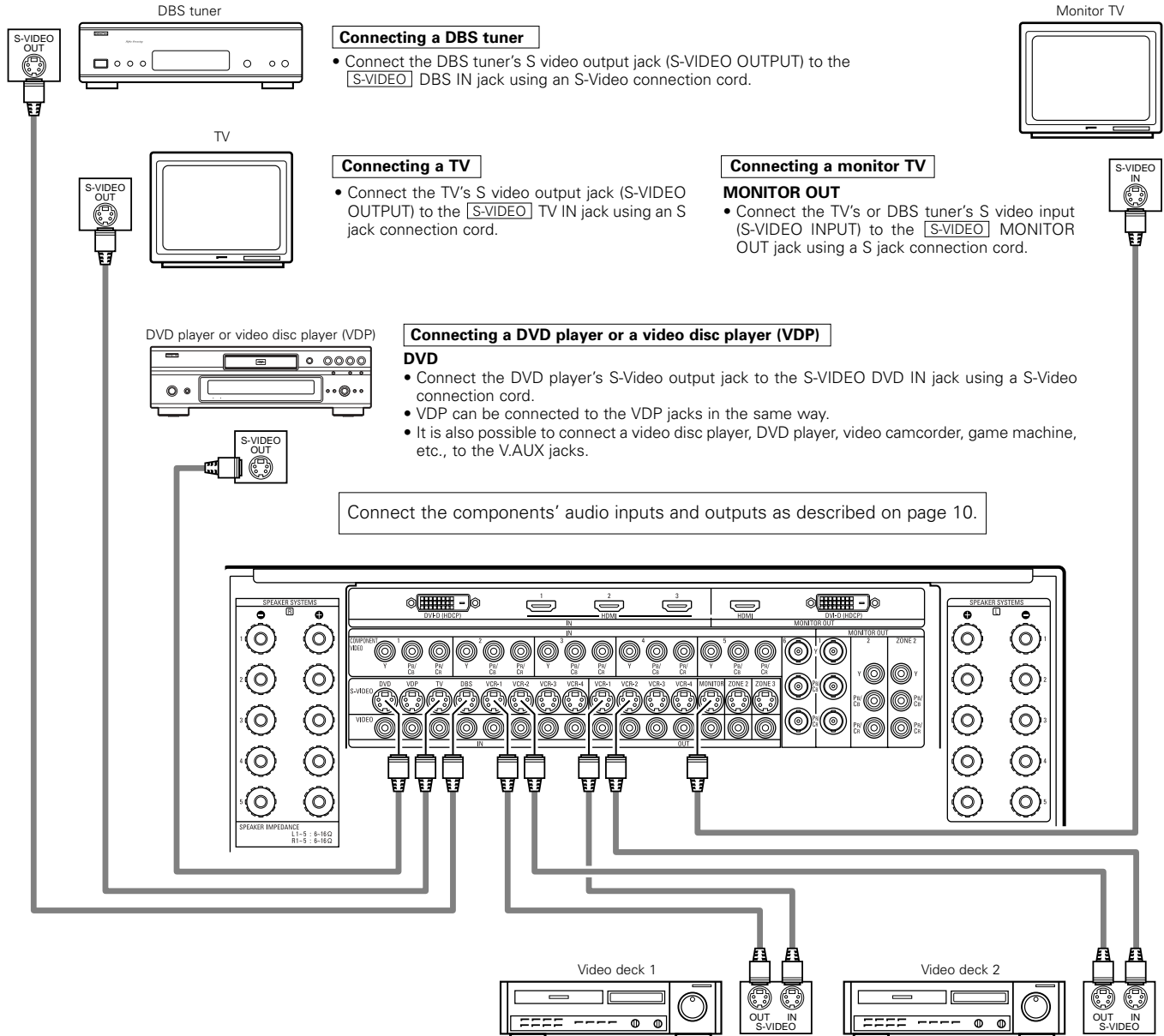

NOTES:

- The video signal ZONE2 MONITOR OUT (yellow), S-Video signal ZONE2 MONITOR OUT jack or component signal ZONE2 MONITOR OUT output switches together with the input function selected with the ZONE2 SELECT (See page 157). To use as the monitor output, set "SOURCE" as the ZONE2 input function. The on-screen display signals are output from the ZONE2 MONITOR OUT (See pages 152~154).
- The video signal ZONE3 MONITOR OUT (yellow) or S-Video signal ZONE3 MONITOR OUT output switches together with the input function selected with the ZONE3/REC SELECT (See page 157). To use as the monitor output, set "SOURCE" as the ZONE3/REC SELECT input function. At this time, the on-screen display signals are not output from the ZONE3 MONITOR OUT (See page 155).

Connecting the video decks

- Connect the video deck's S output jack (S-OUT) to the **S-VIDEO** VCR-1 IN jack and the video deck's S input jack (S-IN) to the **S-VIDEO** VCR-1 OUT jack using S jack connection cords.
 - Connect the video deck's S output jack (S-OUT) to the **S-VIDEO** VCR-2 IN jack and the video deck's S input jack (S-IN) to the **S-VIDEO** VCR-2 OUT jack using S jack connection cords.
- ※ Connect the third and fourth video deck to the VCR-3 and VCR-4 jacks in the same way.

Connecting video components equipped with Component Video (color difference) video jacks (Component - Y, Pb, Pr ; Y, Cb, Cr)

- When making connections, also refer to the operating instructions of the other components.
- The signals input to the component (color difference) video jacks are not output from the VIDEO output jack (yellow) or the S-Video output jack.
- Some video sources with component video outputs are labeled Y, Pb, PR, or Y, Cb, CR, or Y, B-Y, R-Y. These terms all refer to component video color difference output.
- The function assigned to the component video input can be changed at the system setup. For details, see "Setting the Component In Assign". (See pages 71, 72)

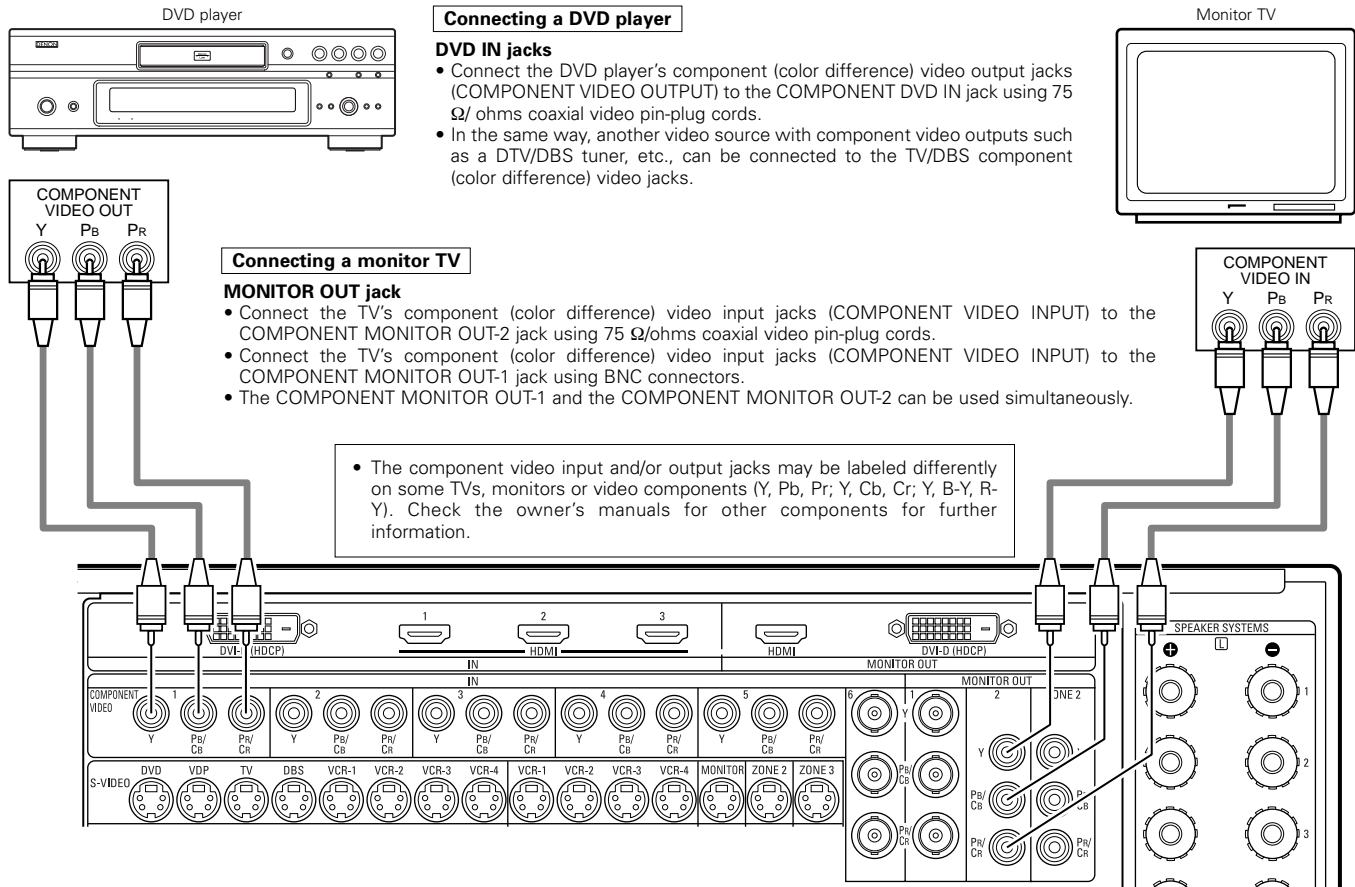

The Video Conversion Function

The AVR-5805 is equipped with a function for up and down converting video signals. Because of this, the AVR-5805's MONITOR OUT jack can be connected to the monitor (TV) with a set of cables offering a higher quality connection, regardless of how the player and the AVR-5805's video input jacks are connected. Generally speaking, connections using the component video jacks offer the highest quality playback, followed by connections using the S-Video jacks, then connections using the regular video jacks (yellow).

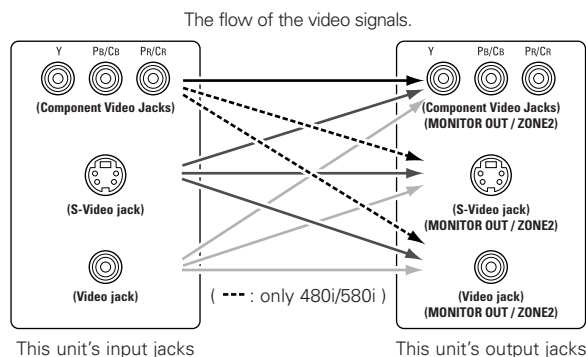

Cautions on the Zone2 video conversion function:

There is no TBC (Time Base Collector) for Zone2. When the component video terminals are used to connect the AVR-5805 with a TV (or monitor, projector, etc.) and the video (yellow) or S video terminals are used to connect the AVR-5805 with a VCR, depending on the combination of the TV and VCR the picture may flicker in the horizontal direction, be distorted, be out of sync or not display at all when playing video tapes. If this happens, connect a commercially available video stabilizer, etc., with a TBC (time base corrector) function between the AVR-5805 and the VCR, or if your VCR has a TBC function, turn it on.

NOTES:

- Video down conversion to the Main Zone's monitor output is only possible when the component video input resolution is 480i (interlaced standard definition video – NTSC format, for North America) or 576i (interlaced standard definition video – PAL format, for Europe and other countries).
- This video conversion function cannot be used with HDMI or DVI video signals.
- When not using the S-Video monitor output connector for the Main zone or Zone2, the composite video input signal is given priority and up-converted to a component video signal. To convert with priority to the S-Video input signal, set the video convert mode to "S-Video". To change the setting of the video conversion mode for the Main zone, see pages 72, 73. To change the setting of the video conversion mode for the Zone2, see pages 93, 94.
- It is not possible to down-convert from the Zone2's component video signal to a S-Video or composite signal, so when not using the Zone2's component monitor output connector, use an S-Video connection cord or composite connection cord to connect the AVR-5805 with the player.

Connecting equipment with HDMI (High-Definition Multimedia Interface) terminals

- A simple 1-cable connection (using a commercially available cable) with a device having an HDMI (High-Definition Multimedia Interface) connector allows digital transfer of the digital images of DVD video and other sources, and the multi-channel sound of DVD audio and DVD video.
- The HDMI and DVI-D monitor output connectors on the AVR-5805 can only be used one at a time, not simultaneously.
- To provide audio output from AVR-5805's audio output connector, select "Amp" at the System Setup.
- To provide audio output from the TV, select "TV" at the System Setup. For details, see "Setting the HDMI/DVI In Assign". (See pages 75, 76)

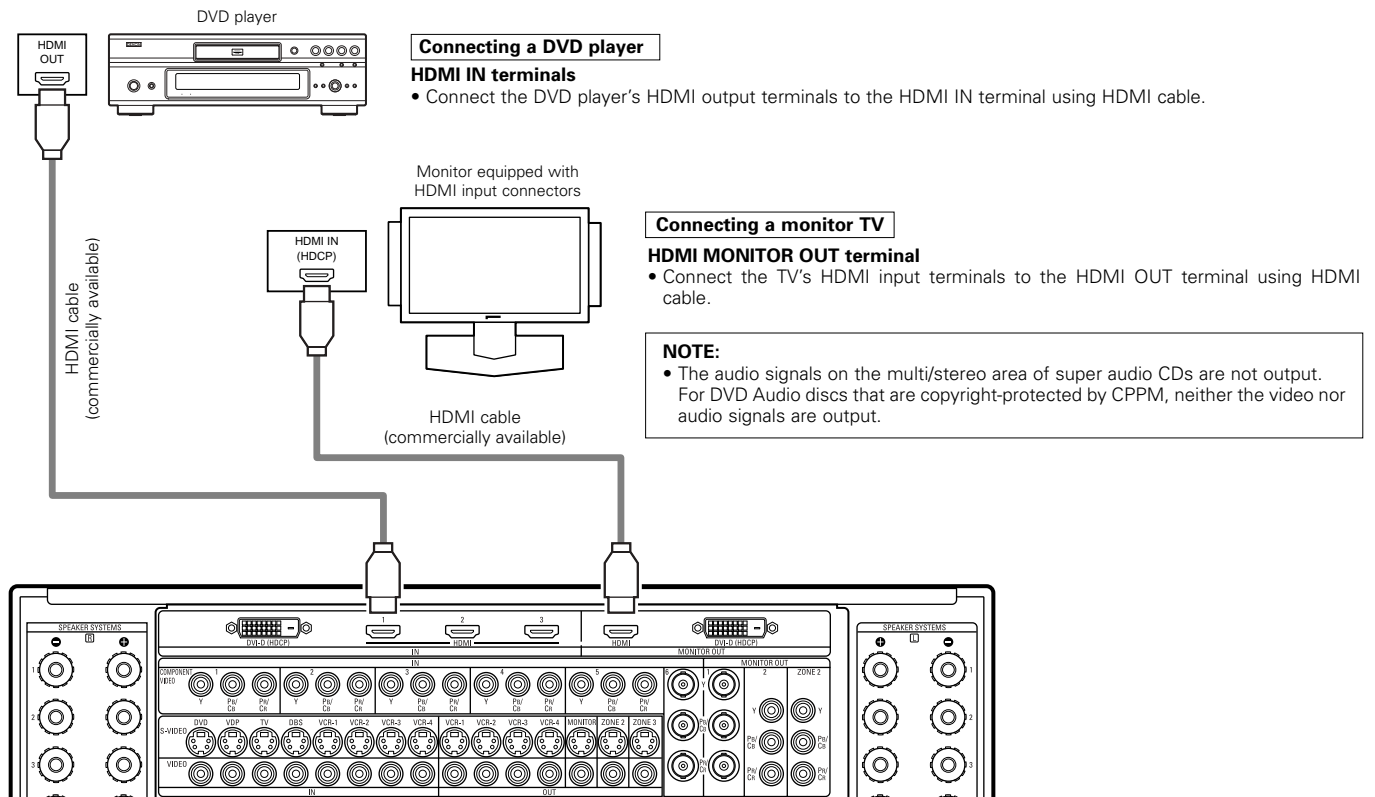

- Among the devices that support HDMI, some devices can control other devices via the HDMI connector; however, the AVR-5805 cannot be controlled by another device via the HDMI connector.
- The audio signals from the HDMI connector (including the sampling frequency and bit length) may be limited by the equipment that is connected.
- The on-screen display signals are not outputted from the HDMI MONITOR OUT.

Copyright Protection System

To play back the digital video and audio of DVD video and DVD audio through an HDMI/DVI-D connection, both the connected player and monitor are required to support a copyright protection system called HDCP (High-bandwidth Digital Content Protection System). HDCP is copy protection technology that comprises data encryption and authentication of the partner equipment. The AVR-5805 supports HDCP. Please see the user's manual of your video display for more information about this.

Connecting equipment with DVI (Digital Visual Interface) terminals

- Connection with equipment that has a DVI (Digital Visual Interface)-D connector permits the transfer of digital images. Make an audio connection also.
- Commercially-available DVI cables are available in 24-pin and 29-pin types. The AVR-5805 supports the 24-pin DVI-D cable.
- The HDMI and DVI-D monitor output connectors on the AVR-5805 can only be used one at a time, not simultaneously.
- The on-screen display signals are not outputted from the DVI-D MONITOR OUT.

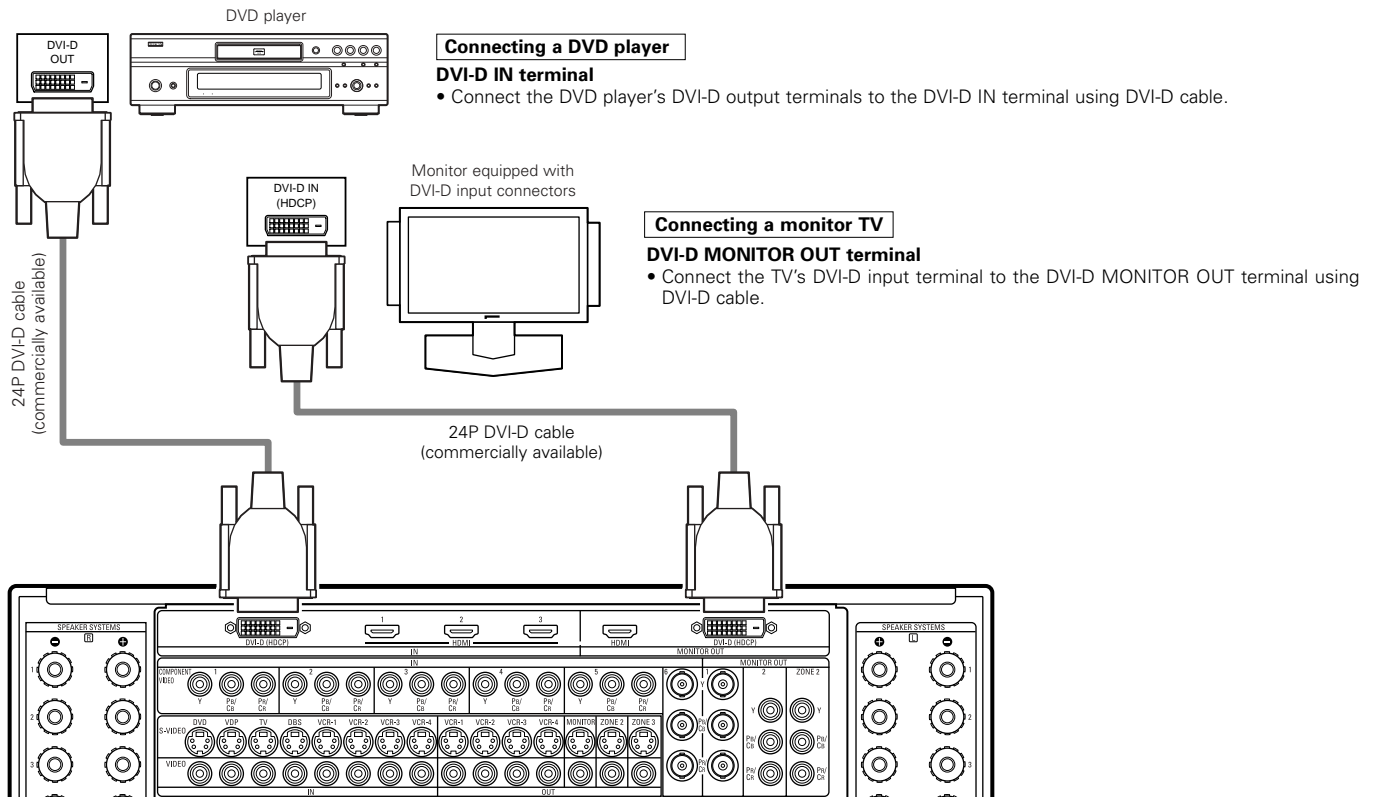

Note on connecting a HDMI/DVI

- The table below indicates the compatibility of connections between the HDMI/DVI-D output connector of the AVR-5805 and monitors that support HDMI/DVI-D.

	Monitor with HDMI	Monitor with DVI-D (HDCP compatible)	Monitor with DVI-D (HDCP incompatible)
HDMI output terminal	○ (Video / Audio)	○ (Only Video)	×
DVI-D output terminal	○ (Only Video)	○ (Only Video)	×

Copyright Protection System

To play back the digital video and audio of DVD video and DVD audio through an HDMI/DVI-D connection, both the connected player and monitor are required to support a copyright protection system called HDCP (High-bandwidth Digital Content Protection System). HDCP is copy protection technology that comprises data encryption and authentication of the partner equipment. The AVR-5805 supports HDCP. Please see the user's manual of your video display for more information about this.

Connecting the antenna terminals

- An F-type FM antenna cable plug can be connected directly.

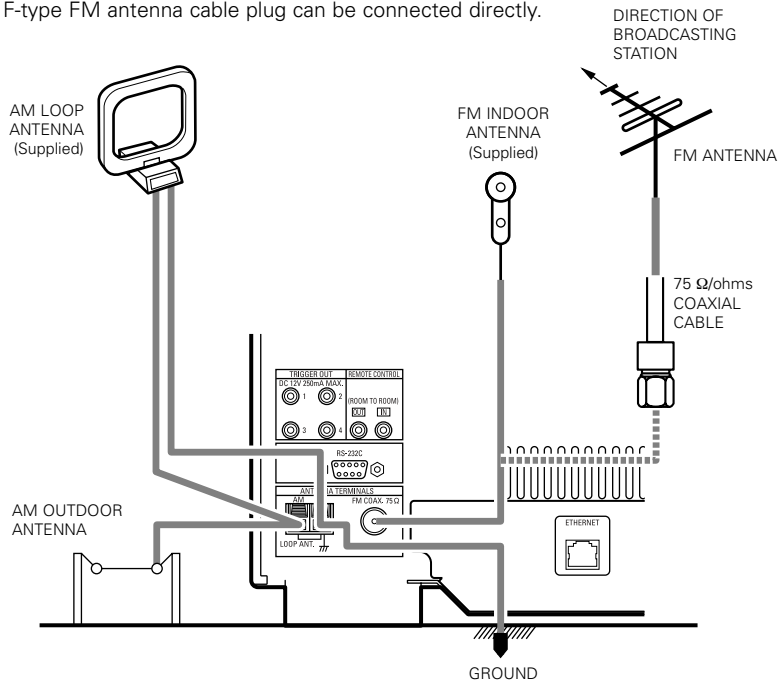

AM loop antenna assembly

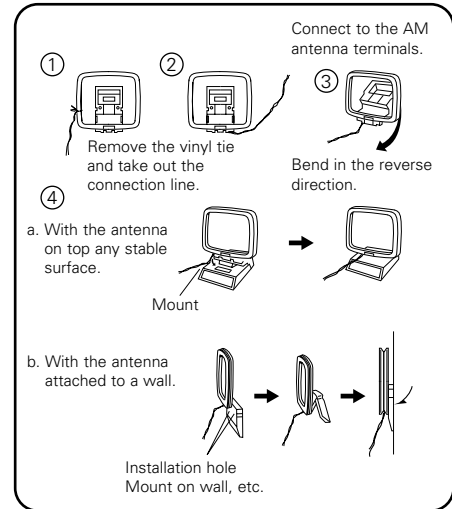

Connection of AM antennas

1. Push the lever.
2. Insert the conductor.
3. Return the lever.

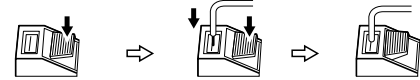

Notes:

- Do not connect two FM antennas simultaneously.
- Even if an external AM antenna is used, do not disconnect the AM loop antenna.
- Make sure AM loop antenna lead terminals do not touch metal parts of the panel.

Note to CATV system installer:

This reminder is provided to call the CATV system installer's attention to Article 820-40 of the NEC which provides guidelines for proper grounding and, in particular, specifies that the cable ground shall be connected to the grounding system of the building, as close to the point of cable entry as practical.

Connecting the external input (EXT. IN) jacks

- AVR-5805 is equipped with two analog external input terminals for 9.1 channels and 5.1 channels.
- These jacks are for inputting multi-channel audio signals from an outboard decoder, or a component with a different type of multi-channel decoder, such as a DVD Audio player, or a multi-channel SACD player, or other future multi-channel sound format decoder.
- When making connections, also refer to the operating instructions of the other components.

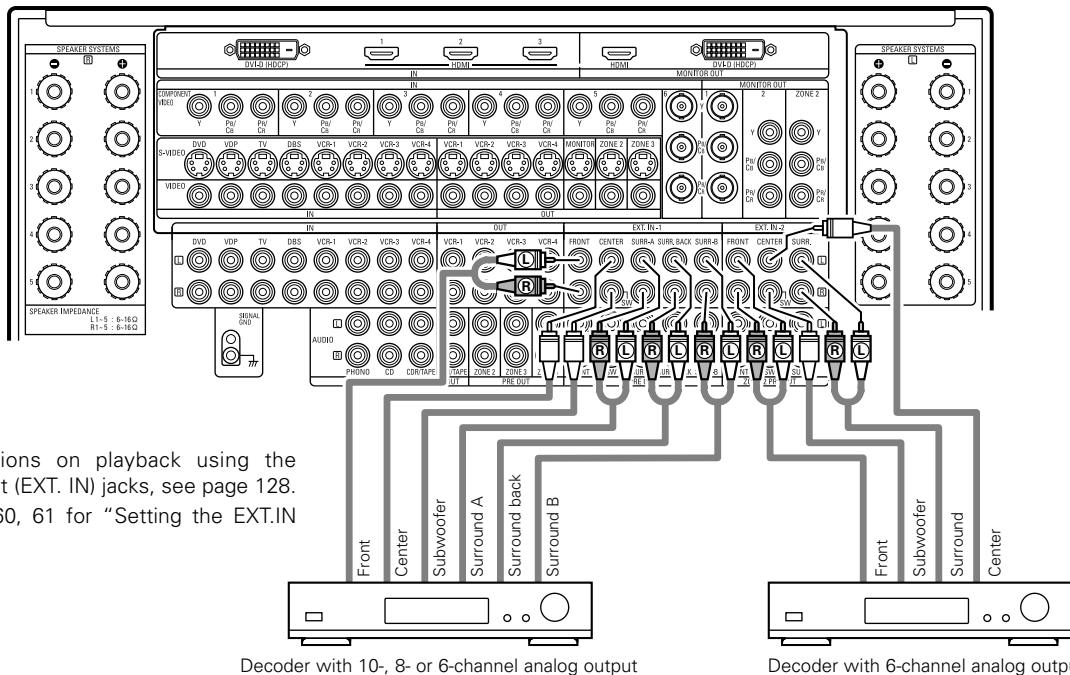

- ※ For instructions on playback using the external input (EXT. IN) jacks, see page 128.
- ※ See pages 60, 61 for "Setting the EXT.IN Setup".

Connecting the ZONE2 jacks

■ ZONE2 preout CONNECTIONS

- If another power amplifier or pre-main (integrated) amplifier is connected, the Zone2 preout (variable level) jacks can be used to play a different program source in Zone2 the same time. (See page 152)
- The Zone2 video out is only use for the Zone2.
- The connection diagram below is an example of multi-channel playback in Zone2. Please see page 154 when you would like to have 2-channel playback in Zone2.

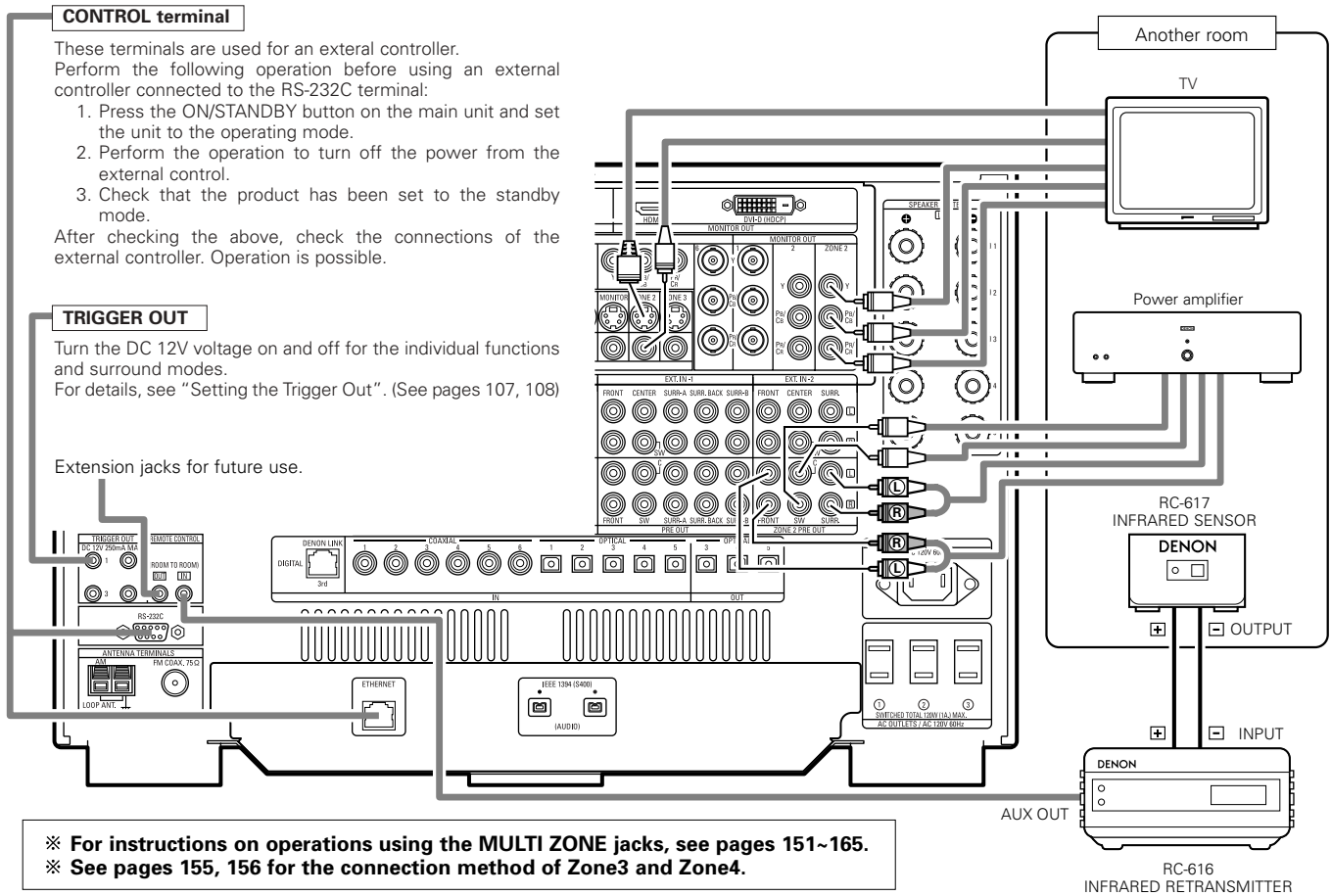

Connecting a component with video and audio jacks to the V.AUX input jacks

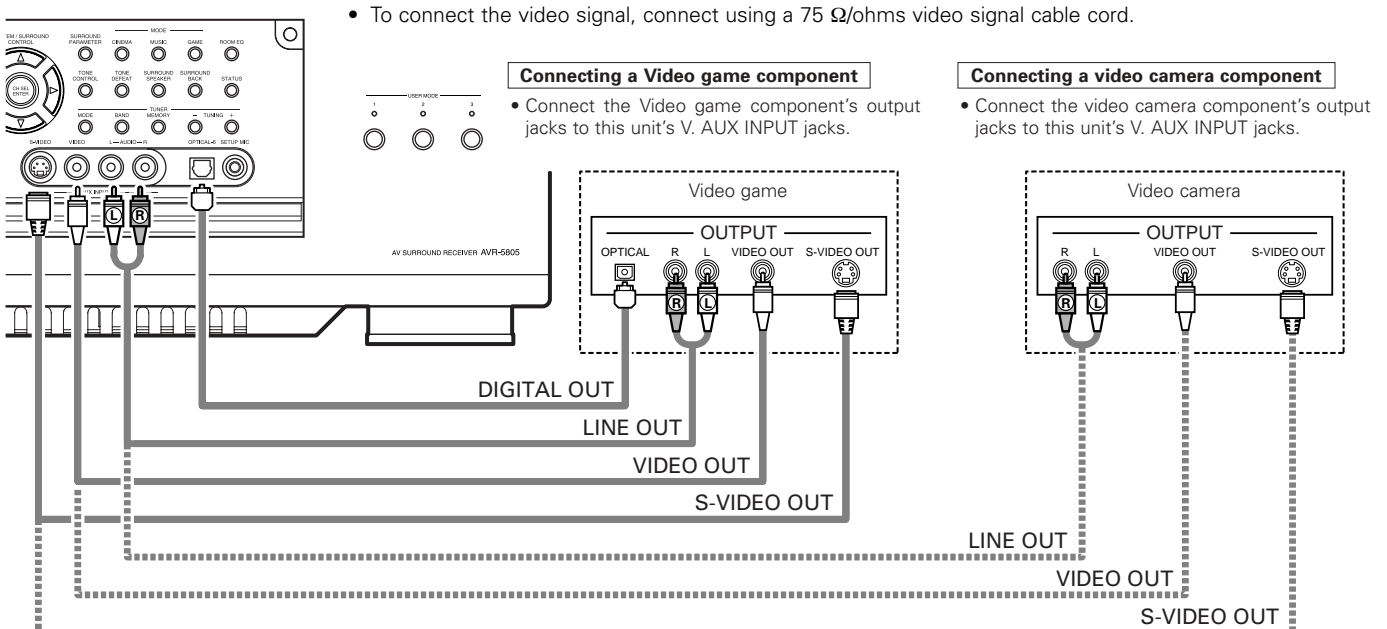

DENON LINK connections

- High quality digital sound with reduced digital signal transfer loss can be enjoyed by connecting a separately sold DENON LINK compatible DVD Player.

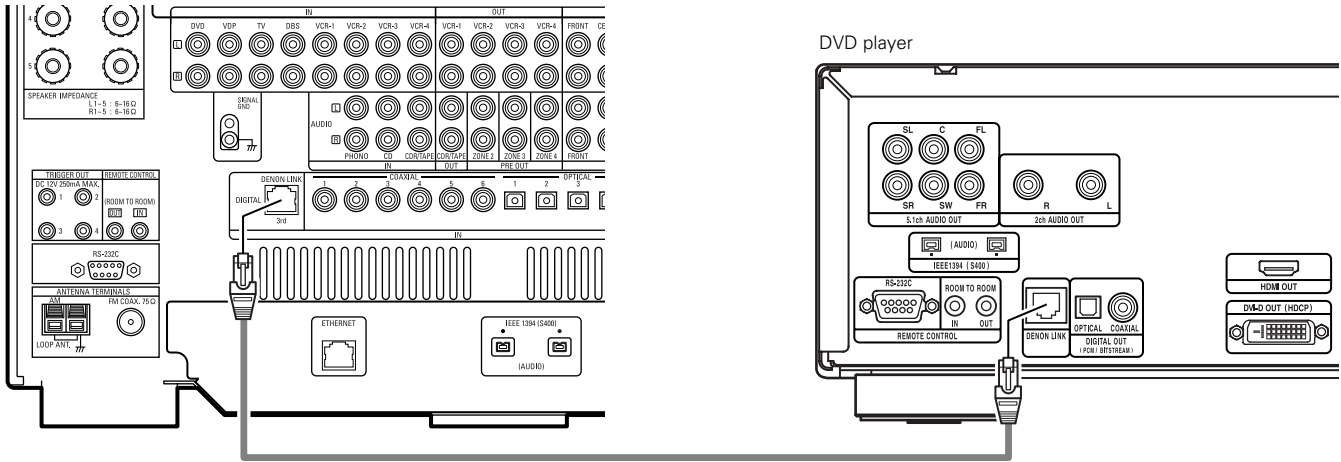

■ Playback using the DENON LINK connector

Digital transfer and multi-channel playback of DVD audio discs and other multi-channel sources is possible by connecting the AVR-5805 to a DENON DVD player equipped with a DENON LINK connector using the connection cable included with the DVD player.

■ DENON LINK Setting

When a DENON DVD player and the DENON LINK have been connected, be sure to make a setting to "DENON LINK" with the System Setup Digital In Assignment. (See pages 58, 59)

- When the input mode is AUTO and the signals are not be able to transferred by DENON LINK, the unit automatically changes over the input to the selected signals (ANALOG, EXT. IN or IEEE1394).

1

Assign DENON LINK to the input source.

① Select the input source.

② Select "DLINK".

3-1. Digital In Assign	
CD :	COAX1 Tape: OPT5
DVD :	DLINK V.Aux: OPT6
VDP :	COAX3
TV :	COAX4
DBS :	COAX5 DLINK
VCR-1 :	OPT1 No Signal
VCR-2 :	OPT2 ◀EXT-1▶
VCR-3 :	OPT3
VCR-4 :	OPT4 Default Yes

*Digital In 3.1
DVD : ◀DLINK▶

2

Select the input for the playback of signals that cannot be transferred by DENON LINK.

① Select "DLINK" setting.

② Select input signal (ANALOG, EXT.IN or IEEE1394).

3-1. Digital In Assign	
CD :	COAX1 Tape: OPT5
DVD :	DLINK V.Aux: OPT6
VDP :	COAX3
TV :	COAX4
DBS :	COAX5 DLINK
VCR-1 :	OPT1 No Signal
VCR-2 :	OPT2 ◀I1▶
VCR-3 :	OPT3 DVD-3910
VCR-4 :	OPT4 Default Yes

*Digital In 3.1
NoSig.: ◀I1▶

Connecting IEEE1394 devices

- Use an S400-compatible 4-pin IEEE1394 cable to connect.
- Video signals are not transferred with the AVR-5805's IEEE1394 interface, so when connecting a video device connect the video signals as well.
- Assign the IEEE1394 input the input source. (See page 65)

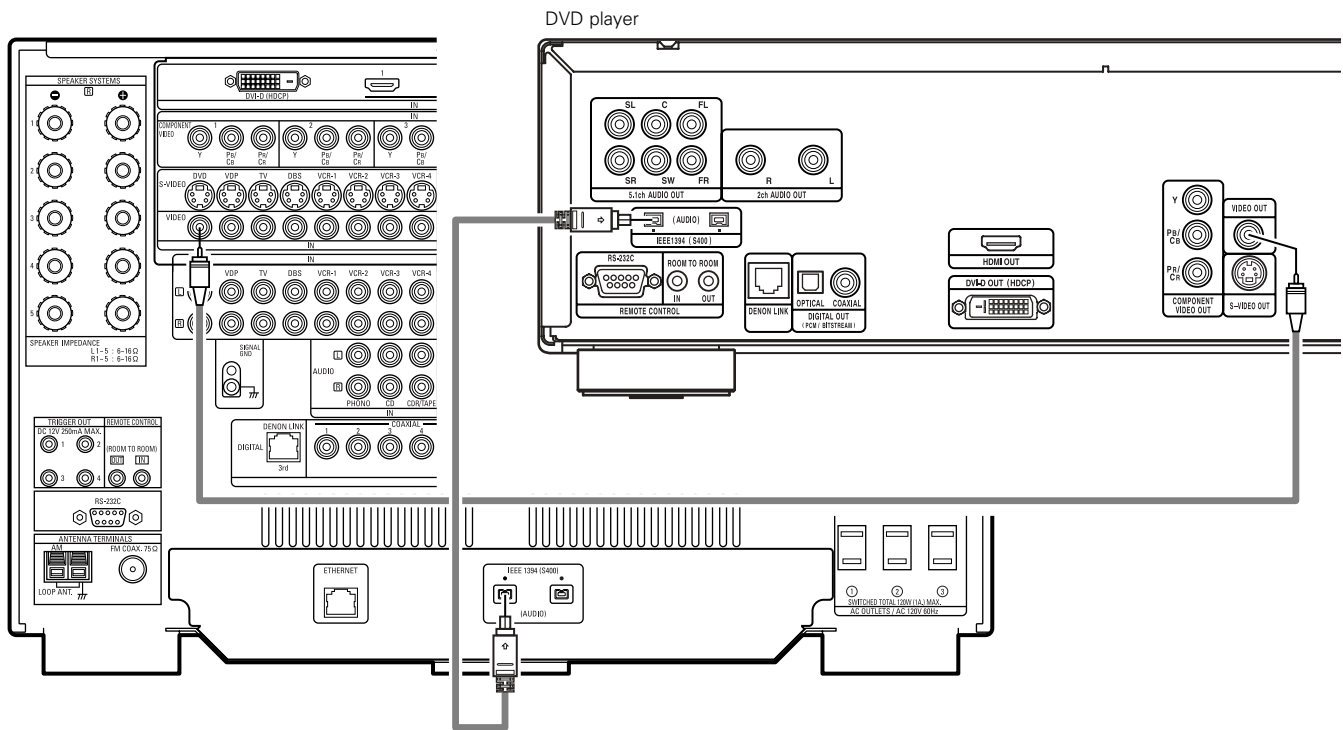

■ IEEE1394 network

- ① Up to 17 devices can be connected using daisy chain type connections.
- ② Up to 63 devices can be connected using tree type connections.
Do not loop the connections.
- ③ Select IEEE 1394 input. "LINK CHECK" will be displayed while the IEEE 1394 connection is being checked.
- ④ If the connection is looped, "LOOP CONNECT" is displayed. Check the connections and undo the loop.

Speaker system connections

- Connect the speaker terminals with the speakers making sure that like polarities are matched (\oplus with \oplus , \ominus with \ominus). Mismatching of polarities will result in weak central sound, unclear orientation of the various instruments, and the sense of direction of the stereo being impaired.
- When making connections, take care that none of the individual conductors of the speaker cord come in contact with adjacent terminals, with other speaker cord conductors, or with the rear panel.

NOTE:

NEVER touch the speaker terminals when the power is on. Doing so could result in electric shocks.

Speaker Impedance

- Speakers with an impedance from 6 to 16 Ω /ohms can be connected.
- The protector circuit may be activated if the set is played for long periods of time at high volumes when speakers with an impedance lower than the specified impedance are connected.

Connecting the speaker cords

1. Loosen by turning counterclockwise.

2. Insert the cord.

3. Tighten by turning clockwise.

Either tightly twist or terminate the core wires.

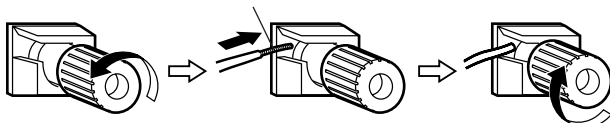

Connecting banana plugs

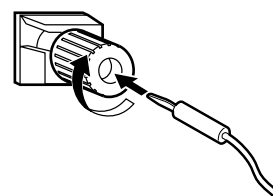

Turn clockwise to tighten, then insert the banana plug.

Protector circuit

- This unit is equipped with a high-speed protection circuit. The purpose of this circuit is to protect the speakers under circumstances such as when the output of the power amplifier is inadvertently short-circuited and a large current flows, when the temperature surrounding the unit becomes unusually high, or when the unit is used at high output over a long period which results in an extreme temperature rise.

When the protection circuit is activated, the speaker output is cut off and the power supply indicator LED flashes. Should this occur, please follow these steps: be sure to switch off the power of this unit, check whether there are any faults with the wiring of the speaker cables or input cables, and wait for the unit to cool down if it is very hot. Improve the ventilation condition around the unit and switch the power back on.

If the protection circuit is activated again even though there are no problems with the wiring or the ventilation around the unit, switch off the power and contact a DENON service center.

Note on speaker impedance

- The protector circuit may be activated if the set is played for long periods of time at high volumes when speakers with an impedance lower than the specified impedance (for example speakers with an impedance of lower than 4 Ω /ohms) are connected. If the protector circuit is activated, the speaker output is cut off. Turn off the set's power, wait for the set to cool down, improve the ventilation around the set, then turn the power back on.

Cooling fan

- The AVR-5805 is equipped with a cooling fan to prevent the temperature inside the set from rising. The fan is activated under certain usage conditions. It is temperature sensitive, to minimize or prevent audible fan noise.

Connections

- By default, the speaker system setting is set to 9.1 channels.
- The output of each power amplifier can be assigned to any desired channel to best suit the application.
For details, refer to “Setting the Channel Setup” and “Setting the Power Amplifier Assignment”. (See pages 97~105)
- When making connections, also refer to the operating instructions of the other components.

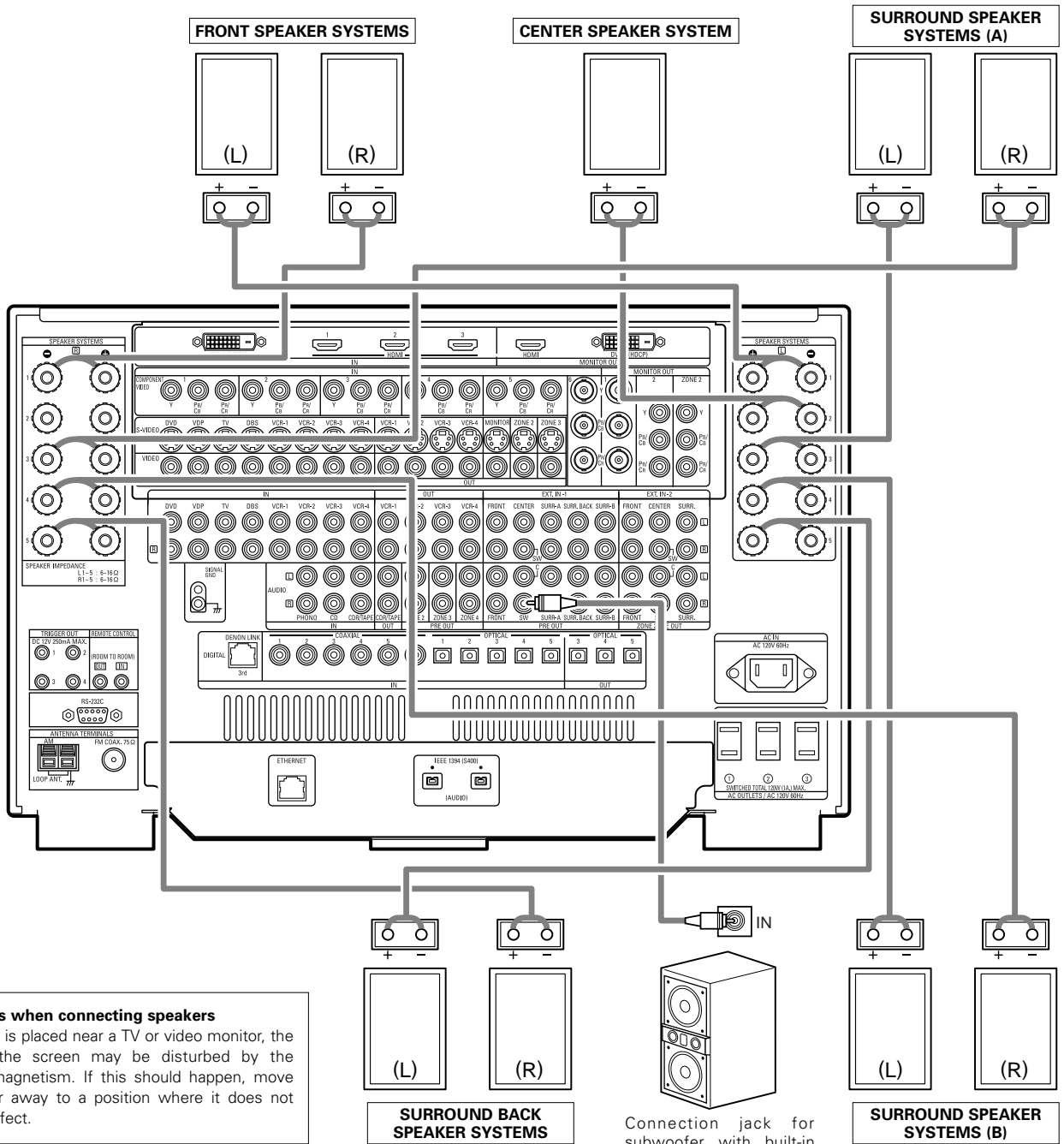

• Precautions when connecting speakers

If a speaker is placed near a TV or video monitor, the colors on the screen may be disturbed by the speaker's magnetism. If this should happen, move the speaker away to a position where it does not have this effect.

NOTE:

- When using only one surround back speaker, connect it to left channel (L5).

6 PART NAMES AND FUNCTIONS

Front Panel

• For details on the functions of these parts, refer to the pages given in parentheses ().

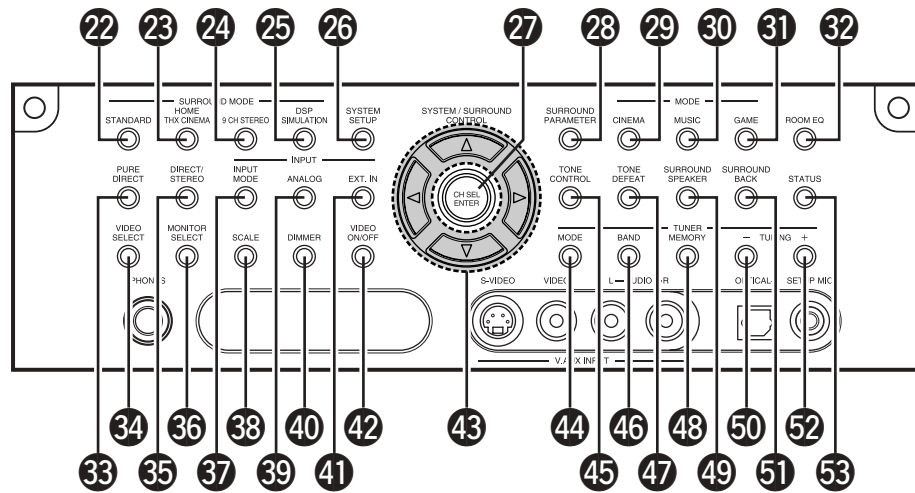
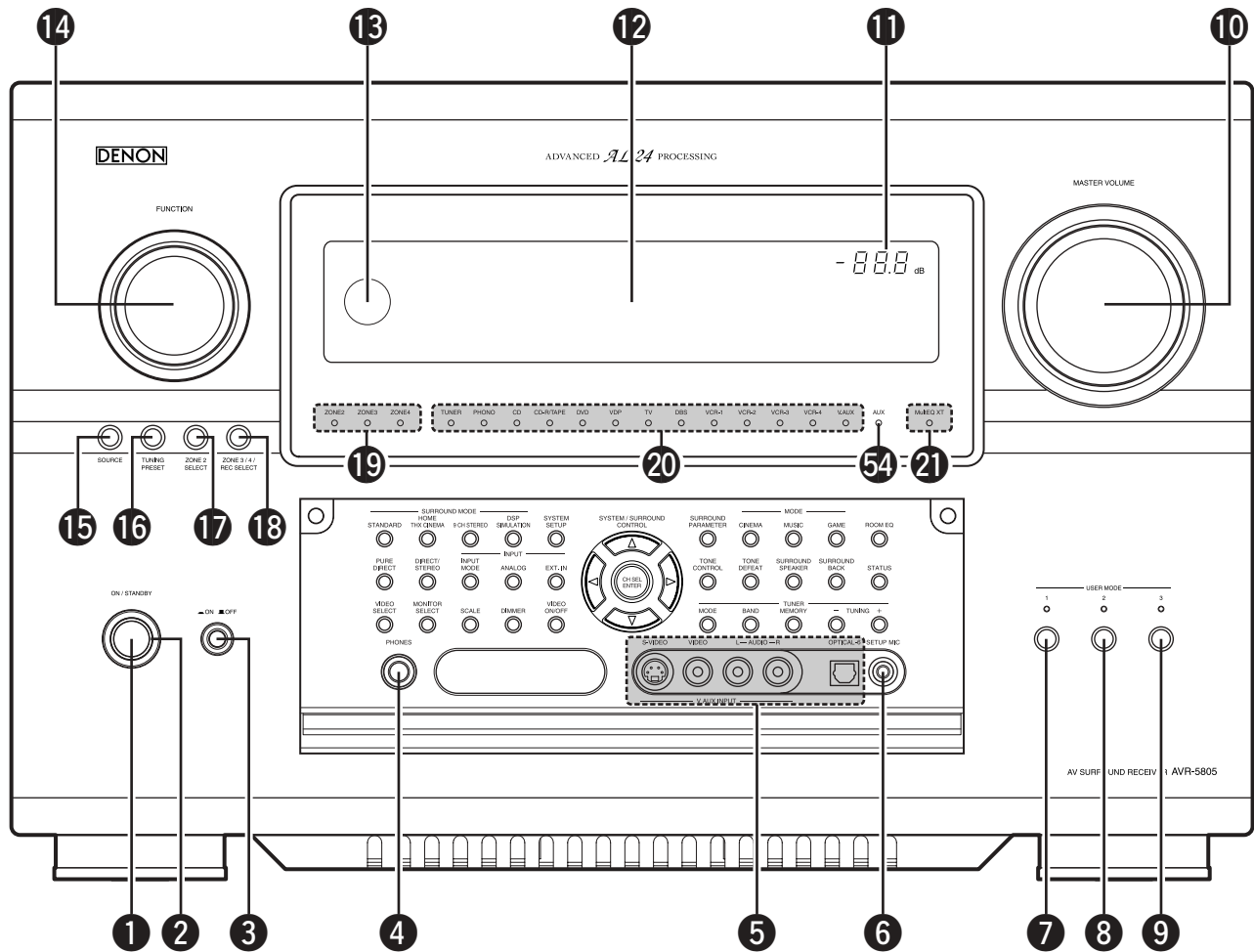

1	Power ON/STANDBY switch	(125)	28	SURROUND PARAMETER button	(137)
2	Power indicator	(125)	29	CINEMA button	(142, 144)
3	Power switch	(125, 173)	30	MUSIC button	(142, 144)
4	Headphones jack (PHONES)	(130)	31	GAME button	(142)
5	V.AUX INPUT jacks	(17)	32	ROOM EQ button	(130)
6	SETUP MIC jack	(32)	33	PURE DIRECT button	(129)
7	USER MODE 1 button	(146)	34	VIDEO SELECT button	(130)
8	USER MODE 2 button	(146)	35	DIRECT/STEREO button	(129)
9	USER MODE 3 button	(146)	36	MONITOR SELECT button	(131)
10	MASTER VOLUME control	(127)	37	INPUT MODE button	(126)
11	Master volume indicator	(127)	38	SCALE button	(132)
12	Display		39	ANALOG button	(126)
13	Remote control sensor	(113)	40	DIMMER button	(131)
14	FUNCTION knob	(126, 132, 133, 157, 168)	41	EXT.IN button	(126, 128)
15	SOURCE button	(126)	42	VIDEO ON/OFF button	(129)
16	TUNING PRESET button	(168)	43	CURSOR button	(26)
17	ZONE2 SELECT button	(157)	44	MODE button	(165, 166)
18	ZONE3/4/REC SELECT button	(132, 133, 157)	45	TONE CONTROL button	(150)
19	Multi Zone power indicators	(158)	46	BAND button	(165, 166)
20	Input source indicators	(126)	47	TONE DEFEAT button	(150)
21	MultEQ XT indicator	(130)	48	MEMORY button	(167)
22	STANDARD button	(140~144)	49	SURROUND SPEAKER button	(131)
23	HOME THX CINEMA button	(137, 139)	50	TUNING down (-) button	(165, 166)
24	9CH STEREO button	(148)	51	SURROUND BACK button	(139, 140)
25	DSP SIMULATION button	(148)	52	TUNING up (+) button	(165, 166)
26	SYSTEM SETUP button	(26)	53	STATUS button	(131)
27	CH SELECT/ENTER button	(26, 134, 135)	54	Extension indicator for future use	

Display

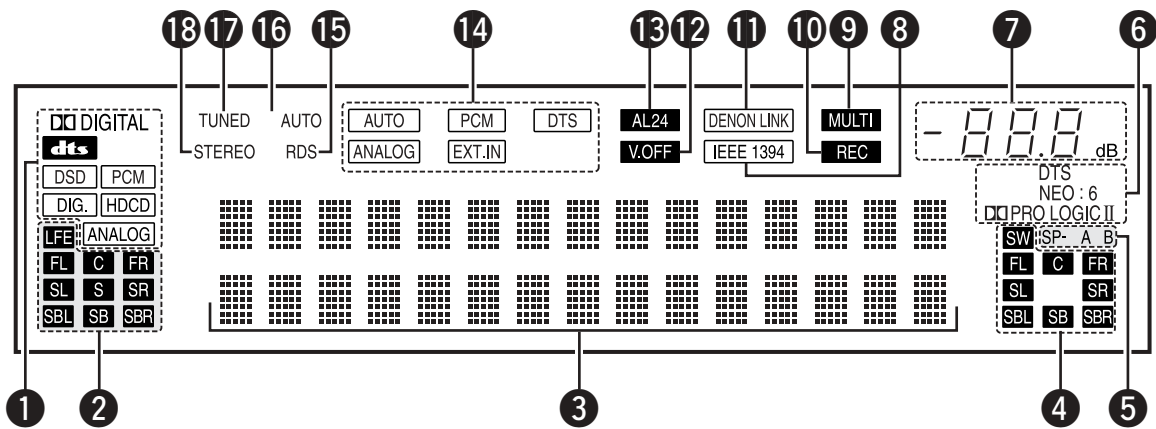

- 1** INPUT SIGNAL indicator
The respective indicator will light corresponding to the input signal.
- 2** INPUT SIGNAL CHANNEL indicator
The channels included in the input source will light.
This lights when the digital signal is inputted.
- 3** Information display
This displays the surround mode, function name or setting value, etc.
- 4** OUTPUT SIGNAL CHANNEL indicator
The audio channels output from this unit will light.
- 5** SPEAKER indicator
This lights corresponding to the settings of the surround speakers of the various surround modes.
- 6** Decoder indicator
This lights when each decoder is operating.
- 7** MASTER VOLUME indicator
This displays the volume level.
The Setup item number is displayed in System Setup.
- 8** IEEE1394 indicator
This lights during playback in a IEEE1394 connection.
- 9** MULTI (ZONE) indicator
ZONE3 mode is selected in ZONE3/REC SELECT.
- 10** REC OUT SOURCE indicator.
REC OUT mode is selected in ZONE3/REC SELECT.
- 11** DENON LINK indicator
This lights during playback in a DENON LINK connection.
- 12** V.OFF indicator
This lights when the operation of the video circuit has been turned off.
- 13** AL24 indicator
The AL24 indicator lights when the PURE DIRECT, DIRECT, STEREO, MULTI CH PURE DIRECT , MULTI CH DIRECT, MULTI CH IN mode is selected in the PCM input signal.
- 14** INPUT MODE indicator
This lights corresponding to the setting of the INPUT mode.
- 15** RDS indicator
This lights when RDS broadcast has been received.
- 16** AUTO indicator
This lights when the broadcast station is selected in the AUTO tuning mode.
- 17** TUNED indicator
This lights when an FM/AM broadcast has been received.
- 18** STEREO indicator
This lights when an FM stereo broadcast has been received.

Remote control unit

- For details on the functions of these parts, refer to the pages given in parentheses ().

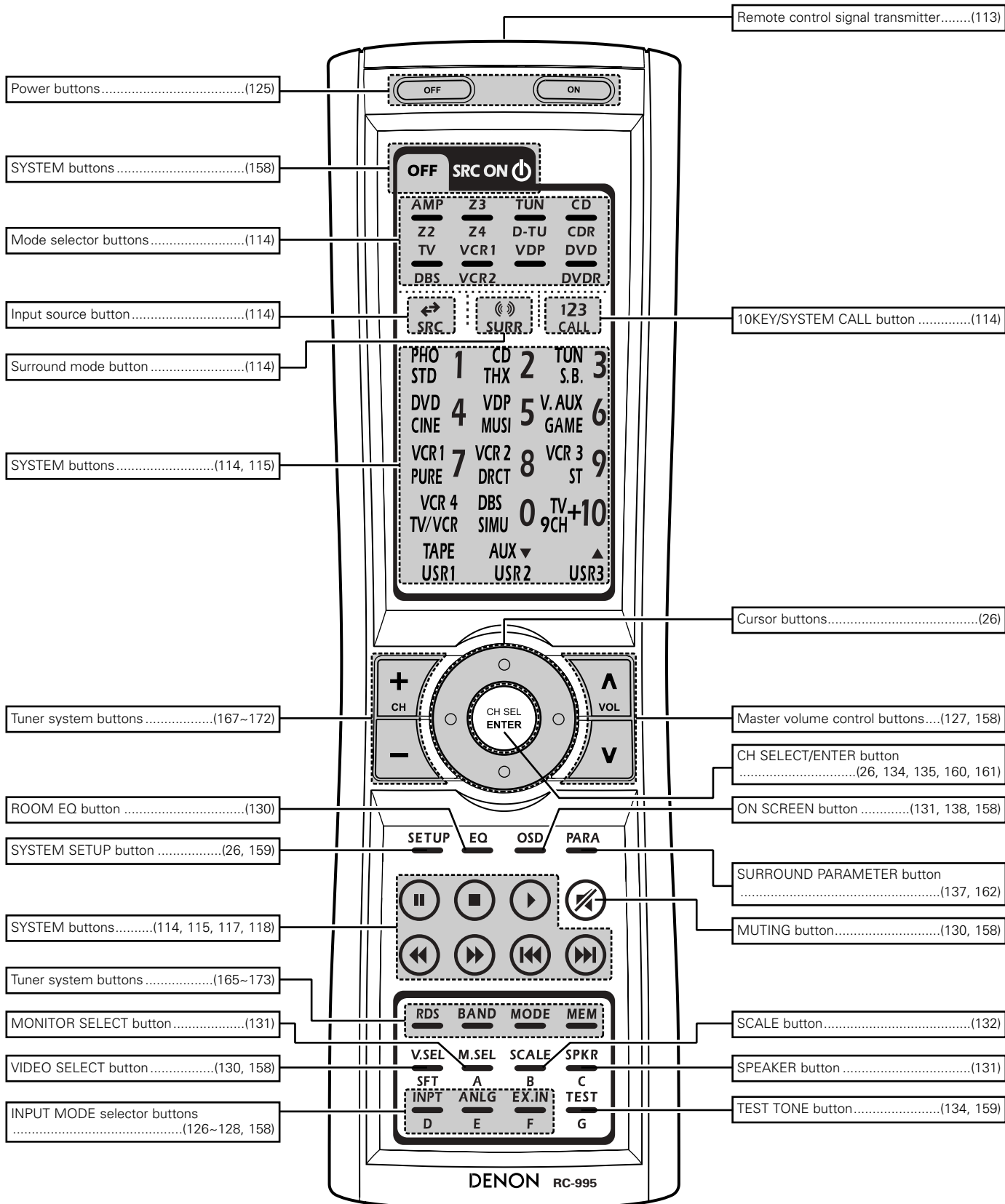

7 SYSTEM SETUP

- Once all connections with other AV components have been completed as described in "CONNECTIONS" (see pages 9~21), make the various settings described below on the monitor screen using the AVR-5805's on-screen display function. These settings are required to set up the listening room's AV system centered around the AVR-5805.

■ Use the following buttons to set up the system

- 1 Check that the remote control unit set to AMP mode.

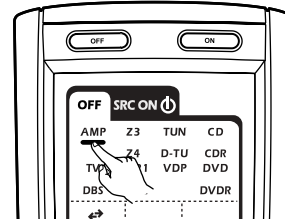

2

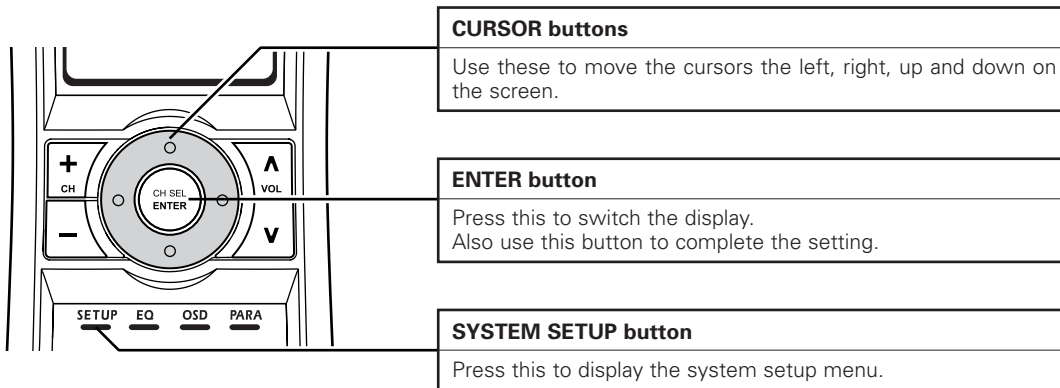

NOTES:

- The AVR-5805's on-screen display function is designed for use with high resolution monitor TVs, so it may be difficult to read small characters on TVs with small screens or low resolutions.
- The setup menu is not displayed when headphones are being used.

■ System setup items and default values (set upon shipment from the factory)

1. Auto Setup/Room EQ

Auto Setup / Room EQ			Default settings	Page
1	Auto Setup	This unit performs an analysis of the speaker system and measures the acoustic characteristics of your room to permit an appropriate automatic setting.	-	33~39
2	Room EQ Setup	Set the Room EQ setting with All or Assign for each surround mode.	All, Room EQ = OFF	40, 41
3	Direct Mode Setup	Set the ON/OFF setting of Room EQ, in the case of the surround mode is in Direct or Pure Direct.	OFF	41
4	Mic Input Select	Set this to switch the Mic Input jack for use for Mic or V.AUX L-channel input jack.	Mic	42, 43

2. Speaker Setup

Speaker Setup				Default settings							Page			
1	Speaker Configuration	Input the combination of speakers in your system and their corresponding sizes (SMALL for regular speakers, LARGE for full-size, full-range) to automatically set the composition of the signals output from the speakers and the frequency response.		Front Sp.	Center Sp.	Subwoofer	Surround Sp. A / B	Surround Back Sp.			46, 47			
				Small	Small	Yes	Small	Small / 2spkrs						
2	Subwoofer Setup	This selects the subwoofer for playing deep bass signals.		LFE —THX—							48			
3	Delay Time	This parameter is for optimizing the timing with which the audio signals are produced from the speakers and subwoofer according to the listening position.		Front L & R	Center	Subwoofer	Surround L & R (A)	Surround L & R (B)	Surround Back			49, 50		
				12 ft (3.6 m)	12 ft (3.6 m)	12 ft (3.6 m)	10 ft (3.0 m)	10 ft (3.0 m)	10 ft (3.0 m)					
4	Channel Level	This adjusts the volume of the signals output from the speakers and subwoofer for the different channels in order to obtain optimum effects.		Front L	Front R	Center	Surround L (A)	Surround R (A)	Surround L (B)	Surround R (B)	Surround Back L	Surround Back R	Subwoofer	51, 52
				0 dB	0 dB	0 dB	0 dB	0 dB	0 dB	0 dB	0 dB	0 dB	0 dB	
5	Crossover Frequency	Set the frequency (Hz) below which the bass sound of the various speakers is to be output from the subwoofer.		FIXED —THX—							53, 54			
6	Surround Speaker Setup	Use this function when using multiple surround speaker combinations for more ideal surround sound. Once the combinations of surround speakers to be used for the different surround modes are preset, the surround speakers are selected automatically according to the surround mode.		Surround mode	THX/DOLBY/DTS CINEMA	THX/DOLBY/DTS MUSIC	THX/DOLBY GAME	WIDE SCREEN	9 CH STEREO	DSP SIMULATION	MULTI CH MODE			55
				Surround speaker	A	A	A	A+B	A+B	A+B	A			
7	THX Audio Setup	Boundary Gain compensation	When using a THX Ultra2 compatible subwoofer, set the subwoofer's frequency response.		THX Ultra2 Subwoofer = NO							56		
		Surround Back Speaker Position	When using two surround back speakers, set the distance of the two speakers.		The Distance Between SBL/SBR = 0 ft to 1 ft (0 m to 0.3 m)							57		

3. Audio Input Setup

Audio Input Setup				Default settings											Page		
1	Digital In Assign	This assigns the digital input jacks for the different input sources.		Input source	CD	DVD	VDP	TV	DBS	VCR-1	VCR-2	VCR-3	VCR-4	CDR/TAPE	V.AUX	58, 59	
				Digital Inputs	COAX 1	COAX 2	COAX 3	COAX 4	COAX 5	OPT 1	OPT 2	OPT 3	OPT 4	OPT 5	OPT 6		
2	EXT.IN Setup	Set the Ext.In terminal playback method.		EXT.IN-1 Setup	Mode = DSP, Surr.B = NOT USED, S.Back = NOT USED, SW Level = +15 dB, Input ATT. = OFF											60, 61	
				EXT.IN-2 Setup	Mode = DSP, SW Level = +15 dB, Input ATT. = OFF												
3	Input Function Lev.	The playback level is corrected individually for the different input sources.		TUNER	PHONO	CD	CDR/TAPE	DVD	VDP	TV	DBS	VCR-1	VCR-2	VCR-3	VCR-4	V.AUX	62
				0 dB	0 dB	0 dB	0 dB	0 dB	0 dB	0 dB	0 dB	0 dB	0 dB	0 dB	0 dB	0 dB	
4	Function Rename	The names of the different input source can be changed as desired and displayed on the display.		TUNER	PHONO	CD	CDR/TAPE	DVD	VDP	TV	DBS	VCR-1	VCR-2	VCR-3	VCR-4	V.AUX	63, 64
5	IEEE1394 Assign	The connected IEEE1394 device can be automatically identified to assign the input source.		-											65		
6	IEEE1394 Auto Func.	Set the function for associating playback of the connected IEEE1394 device on or off.		Auto Function = OFF											66		
7	Tuner Presets	Auto Preset Memory	FM stations are received automatically and stored in the memory.		A1 ~ A8	87.5/89.1/93.1/107.9/90.1/90.1/90.1 MHz											67
					B1 ~ B8	520/600/1000/1400/1500/1710 kHz, 90.1/90.1 MHz											
					C1 ~ C8	90.1 MHz											
					D1 ~ D8	90.1 MHz											
					E1 ~ E8	90.1 MHz											
					F1 ~ F8	90.1 MHz											
		G1 ~ G8	90.1 MHz														
Presets Skip	Preset channels that are not used often can be skipped.		All preset channels = OFF											68			
Presets Name	The preset channels can be given the names you want.		-											69, 70			

4. Video Setup

Video Setup			Default settings								Page		
1	Component In Assign	This assigns the color difference (component) video input jacks for the different input sources.		DVD	VDP	TV	DBS	VCR-1	VCR-2	VCR-3	VCR-4	V.AUX	71, 72
				1-RCA	2-RCA	3-RCA	4-RCA	5-RCA	6-BNC	NONE	NONE	NONE	
2	Video Convert Mode	Set the input signal to be output from the monitor output terminal.		AUTO								72, 73	
3	Video Scaler	Make the settings related to video output (resolution and aspect rate conversion).		Aspect = FULL, Resolution = 480i / 576i								73, 74	
4	3D Y/C Separation	This setting sets the action detection sensitivity of the 3-dimensional Y/C separation at the time of the video signal up-conversion to S-Video.		Motion Detection = MID								74	
5	HDMI/DVI In Assign	The HDMI or DVI input terminals are assigned for the different input sources. Select HDMI or DVI for the monitor output terminal. Select the HDMI audio signal playback method.		DVD	VDP	TV	DBS	VCR-1	VCR-2	VCR-3	VCR-4	V.AUX	75, 76
				NONE	NONE	NONE	NONE	NONE	NONE	NONE	NONE	NONE	
6	Audio Delay	Set the audio delay timing to synchronize the sound and video.		0 ms								76, 77	
7	On Screen Display	This sets whether or not to display the on-screen display that appears on the monitor screen when the controls on the remote control unit or main unit are operated.		Function/Mode = ON, Master Volume = ON, Mode = Mode 1								77, 78	

5. Advanced Playback

Advanced Playback			Default settings				Page
1	2ch Direct/Stereo	The speaker settings can be changed specifically for playing in the 2-channel direct or stereo mode.	Basic				79
2	Dolby Digital Setup	Turn the audio compression on or off when down-mixing Dolby Digital signals.	OFF				80
3	Auto Surround Mode	Set the Auto surround mode function.	Auto Surround Mode = ON				81
4	Manual EQ Setup	This parameter is for optimizing the Room EQ with which the audio signals are produced from the speakers.	All Channels and Frequency=0dB				82~84

6. Zone Setup

Zone Setup			Default settings						Page	
1	Speaker Configuration	The components of the signals output from the various speakers and the frequency response can be set automatically inside the set by inputting the existence/absence of combinations of speakers and their size (corresponding to their low frequency playback capability) for the speakers used in Zone2 during surround playback in Zone2.	Front Sp.	Center Sp.	Subwoofer	Surround Sp.			86	
			Small	Small	Yes	Small				
2	Subwoofer Mode	This selects the subwoofer used in Zone2 for playing the low base sound.	LFE						87	
3	Delay Time	This parameter is for optimizing the timing of the sound produced from the various speakers and subwoofer according to the listening position in Zone2.	Front L & R	Center	Subwoofer	Surround L & R			88, 89	
			12 ft (3.6 m)	12 ft (3.6 m)	12 ft (3.6 m)	10 ft (3.0 m)				
4	Channel Level	This adjusts the volume of the signal output from the various speakers and subwoofer used in Zone2.	Front L	Front R	Center	Surround L	Surround R	Subwoofer	90, 91	
			0.0 dB	0.0 dB	0.0 dB	0.0 dB	0.0 dB	0.0 dB		
5	Crossover Frequency	Set the frequency (in Hz) below which deep bass appearing in the main channels will be routed to the Zone2 subwoofer.	80 Hz						92	
6	Video Setup	Video Convert Mode	Set the input signal to be output from the Zone2 monitor out terminal.						93, 94	
		Audio Delay	Set the delay time the sound is synchronized with the picture which are outputted in Zone2.							
7	Zone3/4 Tone/Ch.Lev.	Adjust the tone and channel level of the sound output from Zone3 and Zone4.	Zone3	Bass = 0 dB, Treble = 0 dB, HPF = OFF, L/R = 0 dB						95, 96
			Zone4	Bass = 0 dB, Treble = 0 dB, HPF = OFF, L/R = 0 dB						

7. Option Setup

Option Setup			Default settings												Page	
1	Channel Setup	The number of channels that you wish to play back in each zone are assigned to each zone accordingly.	Main Zone	Zone2	Zone3	Zone4						97~100				
			9.1 CH	5.1 CH	Stereo			Stereo								
2	Power Amp Assign	Power Amplifiers can be assigned to the various channels according to your system's requirements.	Normal											101~105		
			L1	L2	L3	L4	L5	R1	R2	R3	R4	R5				
3	Volume Control	This sets the volume level of each zone output. Volume Limit: This sets the upper limit for the master volume. Power On Level: This sets the volume level upon switching on the power of each zone. Mute Level: This sets the amount of attenuation of the audio output when each zone is muted. Volume Level: This sets whether the output level of Zone2 to 4 is fixed or variable.	MAIN	Vol.Limit = OFF, P. On Lev. = LAST, Mute Lev. = FULL											106, 107	
			ZONE2	Vol.Lev. = VAR, Vol.Limit = OFF, P. On Lev. = LAST, Mute Lev. = FULL												
			ZONE3	Vol.Lev. = VAR, Vol.Limit = OFF, P. On Lev. = LAST, Mute Lev. = FULL												
			ZONE4	Vol.Lev. = VAR, Vol.Limit = OFF, P. On Lev. = LAST, Mute Lev. = FULL												
4	Trigger Out Setup	This sets the Trigger Out output for the different input sources. If "Zone=Main" is selected, settings can be made for the individual surround modes.	Trigger Out 1	ZONE = MAIN, All Surround Modes = ON												107, 108
				TUNER	PHONO	CD	CDR/TAPE	DVD	VDP	TV	DBS	VCR-1	VCR-2	VCR-3	VCR-4	
			OFF	OFF	OFF	OFF	ON	ON	ON	ON	ON	ON	ON	ON	ON	
			Trigger Out 2	ZONE = 2												
				TUNER	PHONO	CD	CDR/TAPE	DVD	VDP	TV	DBS	VCR-1	VCR-2	VCR-3	VCR-4	
			ON	ON	ON	ON	ON	ON	ON	ON	ON	ON	ON	ON	ON	
			Trigger Out 3	ZONE = 3												
				TUNER	PHONO	CD	CDR/TAPE	DVD	VDP	TV	DBS	VCR-1	VCR-2	VCR-3	VCR-4	
ON	ON	ON	ON	ON	ON	ON	ON	ON	ON	ON	ON	ON				
Trigger Out 4	ZONE = 4															
	TUNER	PHONO	CD	CDR/TAPE	DVD	VDP	TV	DBS	VCR-1	VCR-2	VCR-3	VCR-4	V.AUX			
ON	ON	ON	ON	ON	ON	ON	ON	ON	ON	ON	ON	ON				
5	AC Outlet Assign	This sets the AC outlets to on or off for the different input sources.	AC Outlet 1~3	ZONE = MAIN												109, 110
				TUNER	PHONO	CD	CDR/TAPE	DVD	VDP	TV	DBS	VCR-1	VCR-2	VCR-3	VCR-4	
ON	ON	ON	ON	ON	ON	ON	ON	ON	ON	ON	ON	ON				
6	Setup Memory/Lock	User Memory	This stores the current user settings in the memory.											110, 111		
		Setup Lock	This sets whether or not to lock the system setup settings so that they cannot be changed.													
			-													
			Setup Lock = OFF												111, 112	

■ **Speaker system layout**

Basic system layout (For a THX Ultra2 system)

- The following is an example of the basic layout for a system consisting of eight speaker systems and a television monitor:

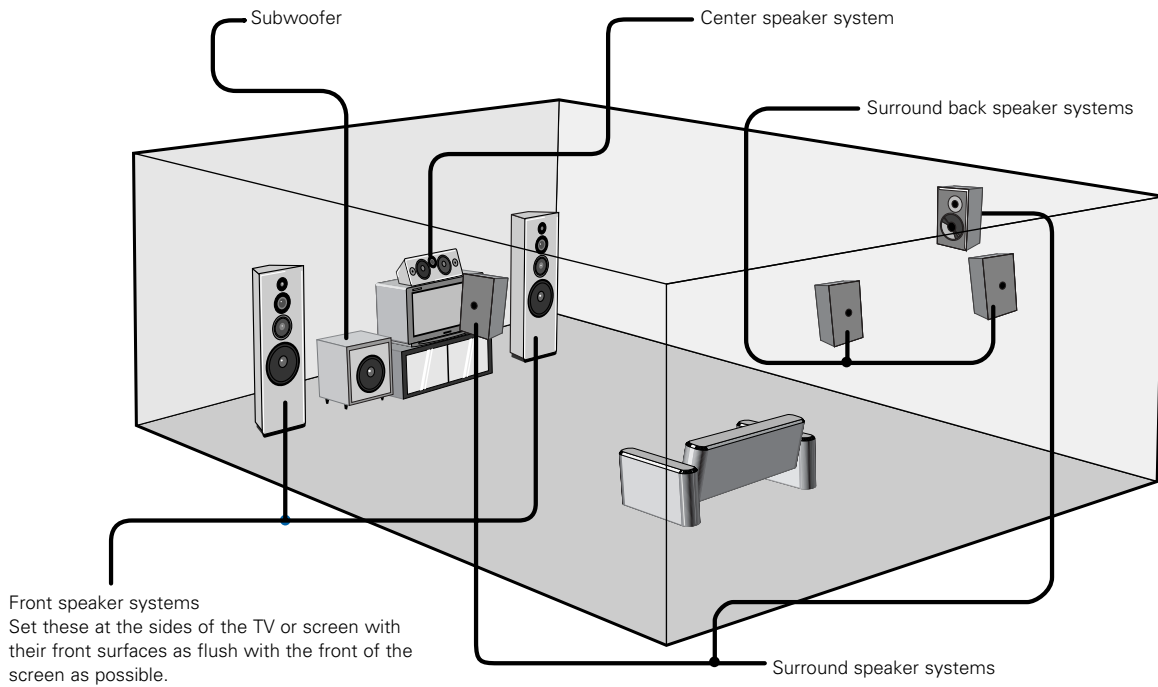

Two surround back speakers are required to use the THX Ultra2 Cinema, THX Music mode and THX Games mode. Set the surround back speakers so that the distance to the listening position is the same for both the left and right speakers. It is also recommended that the deviations of the distance from the listening position to L and R channel speakers (front left (FL) and front right (FR), surround left (SL) and surround right (SR), surround back left (SBL) and surround back right (SBR)) is less than 2 ft (60 cm).

With the AVR-5805 it is also possible to use the surround speaker selector function to choose the best layout for a variety of sources and surround modes.

• **Surround speaker selector function**

This function makes it possible to achieve the optimum sound fields for different sources by switching between two systems of surround speakers (A and B). The settings of the different speakers (A only, B only or A+B) are stored in the memory for the different surround modes, so they are set automatically when the surround mode is selected.

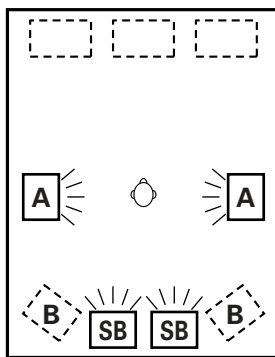

Using A only
(Multi surround speaker system)

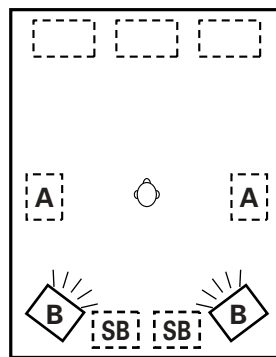

Using B only
(Single surround speaker system)

(SB: Surround Back Speakers)

Before setting up the system

- 1** Check that all the connections are correct, then turn on the main unit's power. Setup will not be possible when the unit is set to Pure Direct ON, the Video Off mode, or when the headphones are plugged in. Therefore, please cancel the mode or reverse the condition.

- 2** Display the System Setup Menu.

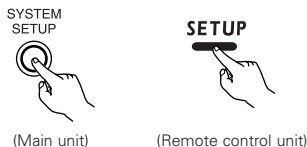

```
*System Setup
Auto Set/RoomEQ
```

System Setup Menu

1. Auto Setup/Room EQ
2. Speaker Setup
3. Audio Input Setup
4. Video Setup
5. Advanced Playback
6. Zone Setup
7. Option Setup
- Exit

NOTES:

- The System Setup menu composition is of a layered design that includes the related items below the large table title as contained in the tables of pages 26~28.
- Wherever your position in System Setup, one more press of the System Setup button permits a move to one level higher.

Auto Setup / Room EQ

The Auto Setup and Room EQ function of this unit performs an analysis of the speaker system and measures the acoustic characteristics of your room to permit an appropriate automatic setting.

The AVR-5805's Audyssey MultEQ XT function has the feature that it provides the optimum listening environment at all listening positions in the home theater, where there are often multiple listeners viewing programs together. To achieve this, it is first necessary to use a microphone to measure test tones generated from the different speakers at the various listening positions. All this measured data is analyzed with a unique method to comprehensively improve acoustic characteristics in the listening area. For optimum effectiveness, measurements should be performed **at six or more points**. Move the microphone successively within the listening area surrounded by the speakers as shown on the diagram below to measure the test tones. When listening to music or viewing movies with the whole family, move the microphone successively to the different positions in which the members of the family sit ("■" on the diagram indicates the points of installation) and measure repeatedly (Example ①). Even if the number of people using the home theater is small, taking multiple measurements at or near the listening positions makes it possible to correct the sound more effectively (Example ②).

The AVR-5805's Room EQ function offers three correction curves: "Audyssey", "Front" and "Flat". These can be selected after performing the auto setup procedure. Details of the different correction curves are described below.

Audyssey : This adjusts the frequency response of all speakers to correct the effects of room acoustics.

Front : This adjusts the characteristics of each speaker to the characteristics of the front speakers.

Flat : This the frequency response of all speakers flat.

This is suitable for multi-channel music reproduction, from discrete music sources such as Dolby Digital 5.1, DTS, DVD-Audio and SACD.

About the main listening position (*M)

The main listening position is the point where a listener sits most often or the listening position when only one person is listening. Measurements on the AVR-5805 start from this point. Correction for the speaker distance ("Delay Time") is set based on this point.

※ When performing Auto Setup, an optional microphone is required for setup.

Example ①:

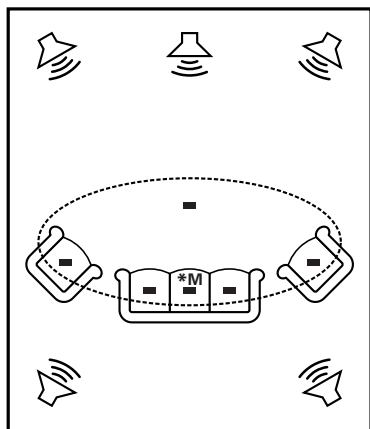

Example ②:

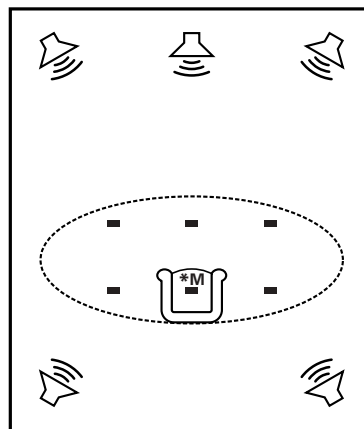

■ Measurement flow

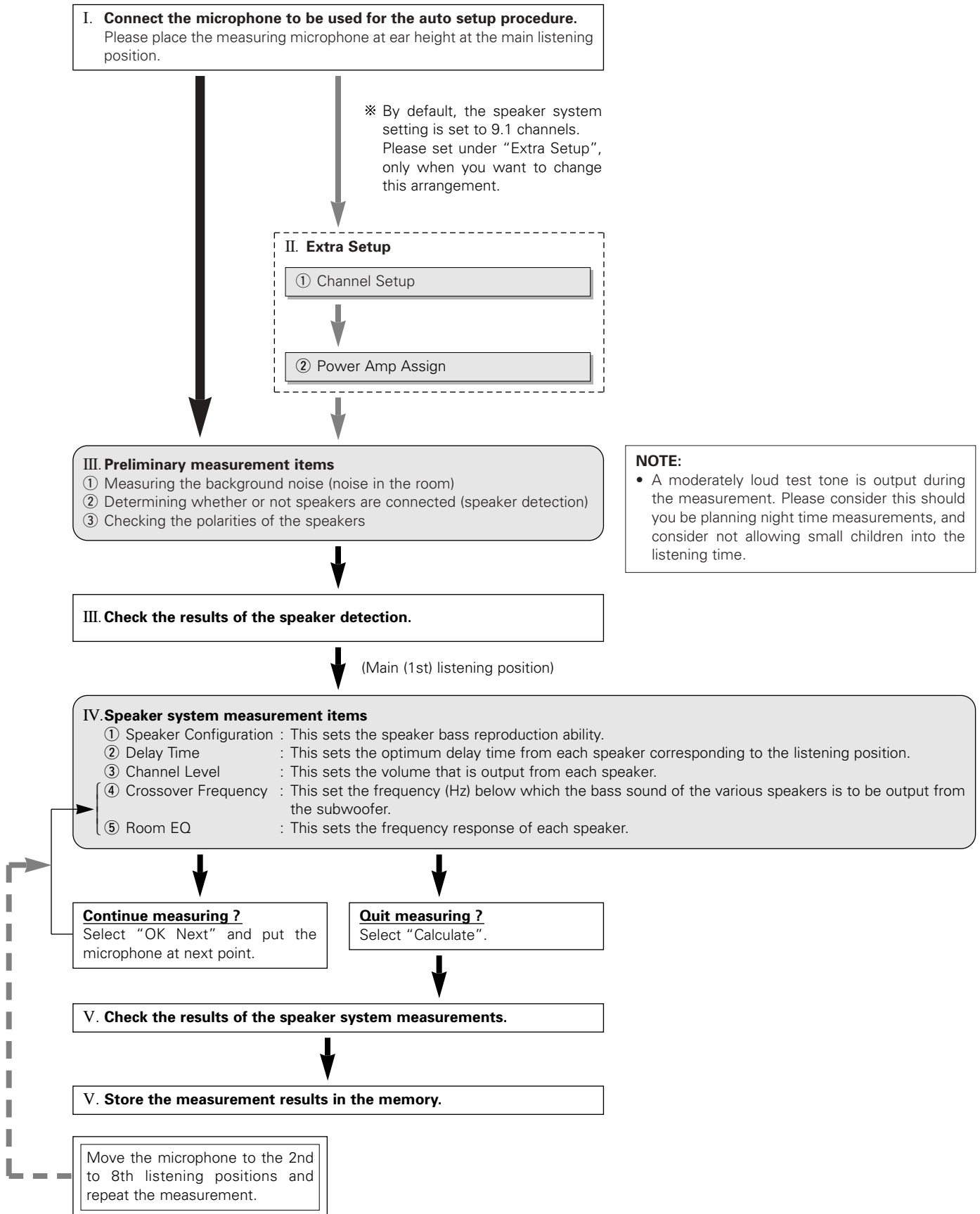

Before performing the Auto Setup procedure

- 1 Check again that the speakers are securely connected to the AVR-5805.
- 2 Set the volume to halfway and set the crossover frequency to the maximum or Low pass filter off if your subwoofer can adjust the output volume and the crossover frequency. Some subwoofers have a standby mode. Be sure to turn this function off before performing the Auto Setup procedure.
- 3 The auto setup procedure uses the OSD (on-screen display) function, so connect the AVR-5805 to a TV, projector, or other monitor.

I. Connecting the microphone for Auto Setup

- 1 Connect the optional microphone for Auto Setup to the Setup Mic connector on the front panel of the unit.

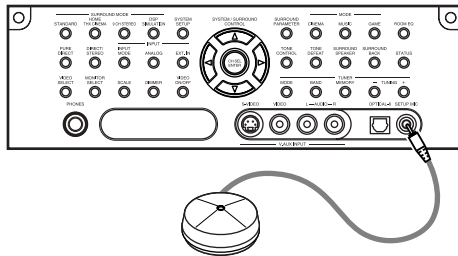

NOTES:

- The optional standard microphone is DENON DM-S305 sold separately.
- When using other microphone, see pages 42, 43.

- 2 Mount the auto setup microphone onto a camera tripod, etc., and place it at ear height at the main listening position (*) in the listening room with the sound receptor facing the ceiling. When placing the microphone, adjust the height so that the microphone's sound receptor is at the height of the ears of the listener. Be sure that at the beginning, the measurement is started with the microphone set up at the main listening position.

NOTE:

- Do not disconnect the microphone until the settings are completed.

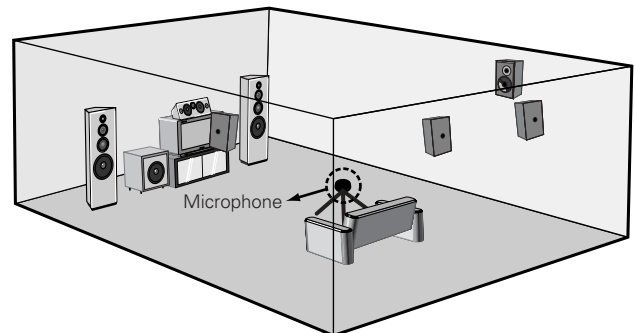

1

Setting the Auto Setup / Room EQ

1

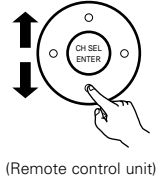
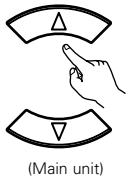

Select "Auto Setup / Room EQ" at the System Setup Menu.

```
*System Setup
Auto Set/RoomEQ
```

System Setup Menu

- 1. Auto Setup/Room EQ
- 2. Speaker Setup
- 3. Audio Input Setup
- 4. Video Setup
- 5. Advanced Playback
- 6. Zone Setup
- 7. Option Setup
- Exit

2

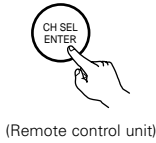

Display the Auto Setup / Room EQ Menu screen.

```
*AutoSet/RoomEQ
Auto Setup
```

1. Auto Setup/Room EQ

- 1. Auto Setup
- 2. Room EQ Setup
- 3. Direct Mode Setup
- 4. Mic Input Select
- 5. Parameter Check

Exit

1-1. Setting the Auto Setup

1

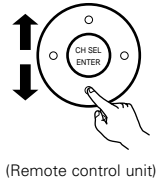
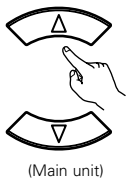

Select "Auto Setup" at the Auto Setup / Room EQ Menu.

```
*AutoSet/RoomEQ
Auto Setup
```

1. Auto Setup/Room EQ

- 1. Auto Setup
- 2. Room EQ Setup
- 3. Direct Mode Setup
- 4. Mic Input Select
- 5. Parameter Check

Exit

2

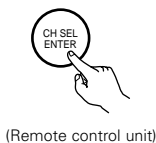

Display the Auto Setup screen.

```
*Auto Setup
Start
```

1-1. Auto Setup

Please place microphone at ear height at main listening position.

```
Extra Setup
Channel:9.1CH
Start
Cancel
```

※ The message "Connect Microphone" is displayed if no microphone is connected. If so, connect the auto setup microphone.

II. Extra Setup

- By default, the speaker system setting is set to 9.1 channels.

Perform this setting if you want to change the channel setup to match the speaker system you are using or to conduct the power amplifier assignment procedure. If you do not want to perform this "Extra Setup" procedure, proceed to the "Preliminary measurements" on page 35.

1

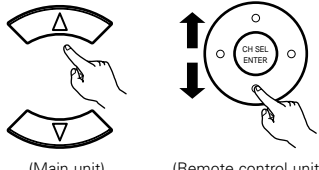

(Main unit) (Remote control unit)

Select "Extra Setup".

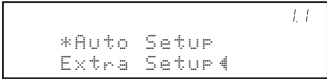
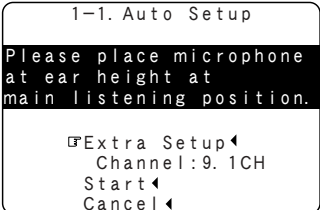

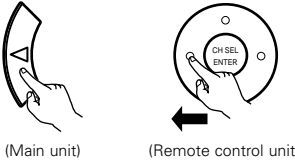

2

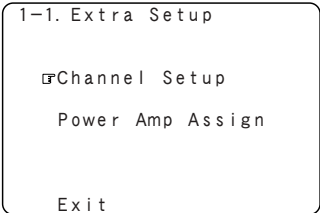

(Main unit) (Remote control unit)

Press the Cursor left button.
Switch to the Extra Setup screen.

3

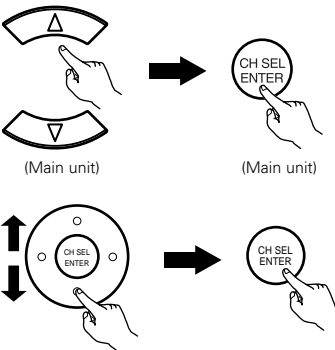

(Main unit) (Main unit)

(Remote control unit) (Remote control unit)

Choose the setting you want to change then press the ENTER button to switch to the setting screen.

- For instructions on making the "Channel Setup" settings, see pages 97~100.
- For instructions on making the "Power Amp Assign" settings, see pages 101~105.

※ The speakers measured with this Auto Setup procedure are based on the setting of these "Channel Setup" and "Power Amp Assign" functions.

4

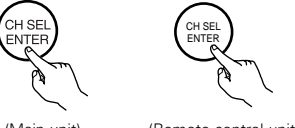

(Main unit) (Remote control unit)

Once the settings are completed, press the ENTER button at the each setting screen.
The Extra Setup Menu re-appears.

5 Select "Exit" and press the ENTER button to return to the Auto Setup screen.

III. Preliminary measurements

- This procedure is used to automatically determine the background noise, whether or not speakers are connected, and the polarities of the connected speakers.

1

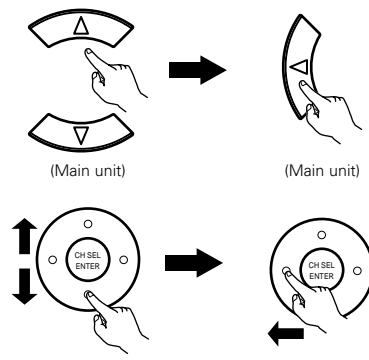

(Main unit) (Main unit)

(Remote control unit) (Remote control unit)

Select the "Start" and press the Cursor left button.
Start the preliminary measurements.

```
*Auto Setup 11
Start
```

1-1. Auto Setup

Please place microphone at ear height at main listening position.

Extra Setup ◀
Channel: 9. 1CH
Start ◀
Cancel ◀

1-1. Auto Setup

Measuring

Speaker Detect

Cancel ◀

Cautions when making the measurements:

- It is not possible to measure properly if there are any obstacles between the speakers and microphone. Check that there are no obstacles.
- Please do not stand between or near the speakers and the microphone during the measurements.
- To avoid affecting the measurements, turn off the air-conditioner or any other device that makes noise and take the measurements with the room as quiet as possible.
- Measurement is canceled when MASTER VOLUME is operated while the Auto Setup is performed.

2



(Main unit) (Remote control unit)

The screen shown at the right appears once the preliminary measurements are completed. Press the ENTER button to switch the Speaker Detect Check screen.

```
Sp Detect Check 11
```

1-1. Auto Setup

Please place microphone at ear height at main listening position.

Speaker Detect Check

OK Start ◀
Retry ◀
Cancel ◀

3



(Main unit) (Remote control unit)

Check the results of the speaker detection. Press the ENTER button to switch to the second screen. If the check ends, press the ENTER button again.

Speaker Detect Check

Front Sp. Yes No
Center Sp. Yes No
Subwoofer Yes No

[First screen]

Speaker Detect Check

Surround Sp. A Yes No
Sp. B Yes No
Sp. Back Yes No
2spkrs 1spkr

[Second screen]

NOTE:

- Subsequent measurements will be made based on this data, so be sure to check the results of these measurements. If the results are not as expected or if an error message is displayed, select "Retry" and perform the measurements again. (For details on the error messages, see page 39.) If the results of remeasurement are still not as expected or if an error message is displayed, turn off the power switch and check the speaker connections. Then start the measurements again from the beginning.

IV. Speaker system measurement

- With these measurements, the "Speaker Configuration", "Delay Time", "Channel Level", "Crossover Frequency" and "Room EQ" are analyzed automatically. The main listening position is measured first, so leave the microphone where it is.

1

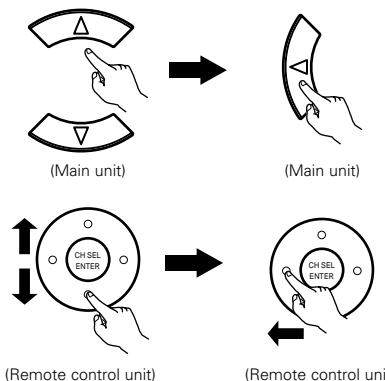

(Main unit) (Main unit)

(Remote control unit) (Remote control unit)

Select the "OK Start" and press the Cursor left button.
Measurements for the first point start.

```

Main Position  ||
OK Start<
    
```

NOTE:

- With these measurements, test tones are not output from channels to which speakers have been judged not to be connected in the preliminary measurements. Do not change the connection of speakers or the subwoofer's volume after performing the preparation measurements and before performing these measurements.

1-1. Auto Setup

Please place microphone at ear height at main listening position.

Speaker Detect Check

OK Start<

Retry <

Cancel <

1-1. Auto Setup

Measuring

Main Position

Cancel <

2

① The screen shown at the right appears once the measurements for the main listening position are completed. Next the measurements for the second point will be taken. Place the microphone at the second listening position. For instructions on the position in which the microphone should be placed, see page 30. (When making the measurements, be sure to position the microphone at the approximate ear height of the seated listener(s).)

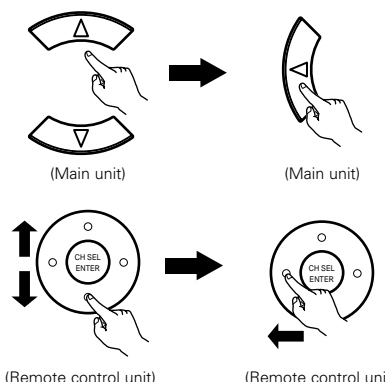

(Main unit) (Main unit)

(Remote control unit) (Remote control unit)

② Select the "OK Next" and press the Cursor left button.
Measurements for the second point start.

```

2nd Position  ||
OK Next<
    
```

1-1. Auto Setup

Please place microphone at ear height at 2nd listening position.

Calculate <

OK Next <

Retry <

Cancel <

1-1. Auto Setup

Measuring

2nd Position

Cancel <

- 3** Perform step 2 repeatedly. The more measurement points, the better the resulting room correction effect. We recommend a minimum of 6 measurement points – 8 measurement points provides the best room correction effect.

4

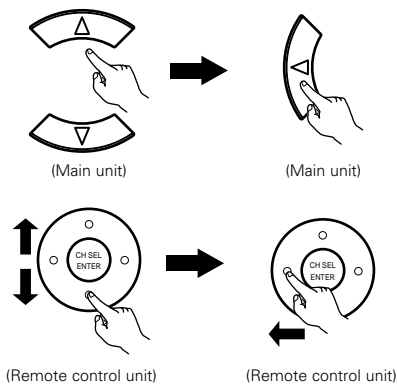

After measuring at the number of points according to your listening environment, select "Calculate" and press the Cursor left button. The speaker system is analyzed.



- ※ The amount of time required for the analysis depends on the number of speakers and the number of measuring points. The greater the number of speakers and measuring points, the longer the time required. For example, for 9.1-channel systems and 6 measuring points, the calculations require approximately 5 minutes.
- ※ Measurements can be ended when there are 5 or more measurement locations; however, to obtain better results, measurements at **6 or more locations** is recommended.

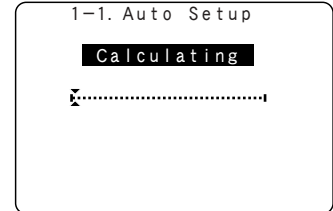

5

Once the calculations are completed, a screen for confirming the results of the measurements appears.

V. Check of the measurement result

- The results of the measured items can be checked.
For instructions on checking the equalizer parameters, see pages 43~45.

1

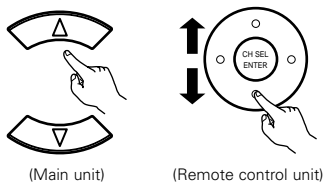

(Main unit) (Remote control unit)

Select the items.
The measurement results of each item can be checked here.

```
*Auto Setup
SP Config.Check
!!
```

```
1-1. Auto Setup
Speaker Config. Check
Delay Time Check
Channel Level Check
Crossover Freq. Check

Store ◀
Cancel ◀
```

2

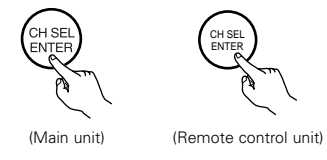

(Main unit) (Remote control unit)

Press the ENTER button and display the verification screen.
Press the ENTER button to switch to the second screen.

NOTE:

- When measurements have been made using the measurement microphone, speakers with a built-in filter such as subwoofers might be set with a value that differs from the physical distance because of the internal electrical delay.

[Speaker Config. Check]	[Delay Time Check]	[Channel Level Check]	[Crossover Freq. Check]
<p>Speaker Config. Check</p> <p><input checked="" type="checkbox"/> Front Sp. Large Small</p> <p>Center Sp. Small None</p> <p>Subwoofer Yes No</p>	<p>Delay Time Check</p> <p>FL 12.0ft FR 12.0ft C 12.0ft SW 12.0ft</p>	<p>Channel Level Check</p> <p>FL 0.0dB FR 0.0dB Center 0.0dB Subwoofer 0.0dB</p>	<p>Crossover Freq. Check</p> <p>Front Small: 80Hz Center Small: 80Hz Surround A Small: 80Hz Surround B Small: 80Hz S. Back Small: 80Hz</p>
<p>Speaker Config. Check</p> <p><input checked="" type="checkbox"/> Surround Sp. A Small None</p> <p>Sp. B Small None</p> <p>Sp. Back Small None</p> <p>2spkr 1spkr</p>	<p>Delay Time Check</p> <p>SL A 10.0ft SR A 10.0ft SL B 10.0ft SR B 10.0ft SBL 10.0ft SBR 10.0ft</p>	<p>Channel Level Check</p> <p>SL A 0.0dB SR A 0.0dB SL B 0.0dB SR B 0.0dB SBL 0.0dB SBR 0.0dB</p>	

3

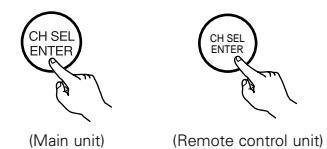

(Main unit) (Remote control unit)

If the check ends, press the ENTER button again.

4

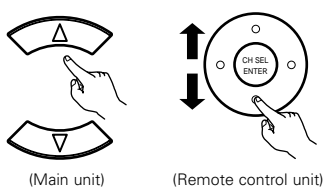

(Main unit) (Remote control unit)

Select whether or not to save the data you have checked.
Select the following items based on the measurement results.

Store : Set with the checked measurement value.
Cancel : If you do not want to set the contents you have checked, cancel the auto setup settings.

```
*Auto Setup
Store ◀
!!
```

```
1-1. Auto Setup
Speaker Config. Check
Delay Time Check
Channel Level Check
Crossover Freq. Check

Store ◀
Cancel ◀
```

5



(Main unit)

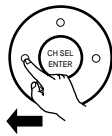

(Remote control unit)

When “Store” is selected, all parameters are stored up.
After the data is stored, the “Auto Setup / Room EQ Menu” screen appears automatically.

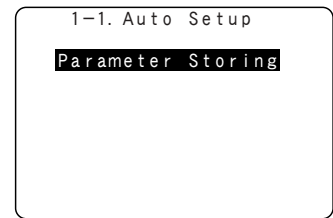

NOTE:

- Do not turn off the power while the data is being stored. If the power is turned off while the data is being stored, the Room EQ parameters stored in the memory will be cleared, and it will not be possible to select the “Audyssey”, “Front” or “Flat” equalizer settings.

About the error message

- These error messages will be displayed when performing the measurements of Auto Setup and the automatic measurements can not be completed because of the speaker arrangement, measurement environment, or other factors. Please check the following matters, reset the pertinent items, and measure again. Be sure to turn off the AVR-5805’s power before checking the speaker connections.

Screen example	Cause	Measures
	<ul style="list-style-type: none"> • The speakers required for producing suitable reproduction have not been detected. <ol style="list-style-type: none"> ① The front L and front R speakers were not properly detected. ② Only one channel of the surround (A) and surround (B) speakers was detected. ③ Sound was output from the R channel when only one surround back speaker was connected. ④ The surround back or the surround (B) speaker was detected, but the surround (A) speaker was not detected. ※ If multiple errors occur, use the cursor left and right buttons to check the contents. 	<ul style="list-style-type: none"> • Check that the pertinent speakers are properly connected.
	<ul style="list-style-type: none"> • The speaker polarity is connected in reverse. ※ If multiple errors occur, use the cursor left and right buttons to check the contents. 	<ul style="list-style-type: none"> • Check the polarity of the pertinent speakers. • For some speakers, the screen below may be displayed even though the speakers are properly connected. If so, select “Skip◀”.
	<ul style="list-style-type: none"> • There is too much ambient noise in the room and the measurements cannot be made accurately. 	<ul style="list-style-type: none"> • Either turn off the power of the device that generated the noise during the measurements or move the device away. • Try again at a time when it is quieter.
	<ul style="list-style-type: none"> • The measurement microphone is not connected, or all of speakers have not been detected. 	<ul style="list-style-type: none"> • Connect the measurement microphone to the microphone connector. • Check the speaker connection.

1-2. Setting the Room EQ Setup

- Select the setting of an Equalizer that has been set with Auto Setup or Manual EQ.

1

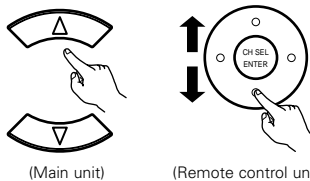

(Main unit) (Remote control unit)

Select "Room EQ Setup" at the Auto Setup / Room EQ Menu.

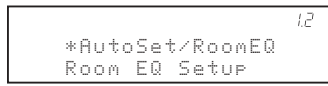

1. Auto Setup/Room EQ

1. Auto Setup
 2. Room EQ Setup
 3. Direct Mode Setup
 4. Mic Input Select
 5. Parameter Check

Exit

2

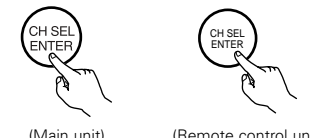

(Main unit) (Remote control unit)

Display the Room EQ Setup screen.

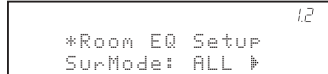

1-2. Room EQ Setup

Relation To
The Surround Mode

ALL ◀ ▶ Assign

3

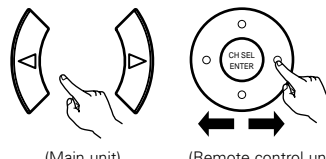

(Main unit) (Remote control unit)

Select All or Assign.

All : Sets the Equalizer for all surround modes.
Assign : Sets the Equalizer individually for each surround mode.

4

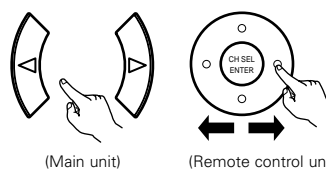

(Main unit) (Remote control unit)

① When the "All" is selected and press the ENTER button, display the Select the EQ Curve screen. Select the Equalizer setting.

1-2. Room EQ Setup

Select The EQ Curve

Room EQ ◀ Audyssey ▶

OFF : The Equalizer is not used.
Audyssey : Adjusts the frequency response of all speakers to correct the effects of room acoustics.
Front : Adjusts the frequency response of the surround speakers to match the characteristics of the front channel speakers.
Flat : Adjusts the frequency response of all speakers to the flattest response. This mode is suitable for multi-channel music surround sound sources.
Manual : Selects the setting value that was set in the Manual EQ setup.
 ※ For details of the "5-4. Manual EQ Setup", see pages 82~84.

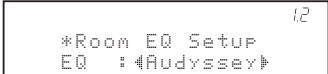

② If "Assign" is selected, select the desired equalizer setting using the ROOM EQ buttons on the Main unit or Remote control unit. Equalizer settings for the individual surround modes can be stored in the memory.

※ Whenever the ROOM EQ button on Main unit or Remote control unit is pressed, the display switches as shown below.

→ OFF → Audyssey → Front

← Manual ← Flat ←

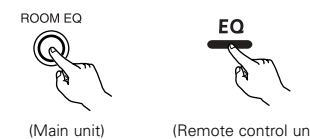

(Main unit) (Remote control unit)

NOTES:

- The Equalizer setting of "Audyssey", "Flat" and "Front" can be selected after performing the Auto Setup.
- When the speaker set as "None" with the Auto Setup is changed to on manually, the equalizer of "Audyssey", "Front" and "Flat" cannot be used.
- The Equalizer setting can be selected directly by ROOM EQ button on the Main unit or Remote control unit.
- When headphones are connected, the Room EQ cannot be used.

5



(Main unit)



(Remote control unit)

Enter the setting.
The Auto Setup / Room EQ Menu reappears.

1-3. Setting the Direct Mode

- Perform the ON/OFF setting of Room EQ when the surround mode is Direct or Pure Direct.

1

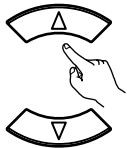

(Main unit)

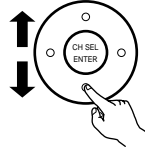

(Remote control unit)

Select "Direct Mode Setup" at the Auto Setup / Room EQ Menu.

```

13
*AutoSet/RoomEQ
Direct Mode

```

1. Auto Setup/Room EQ

1. Auto Setup
2. Room EQ Setup
3. Direct Mode Setup
4. Mic Input Select
5. Parameter Check

Exit

2



(Main unit)



(Remote control unit)

Display the Direct Mode Setup screen.

```

13
*Direct Mode
Room EQ: 4 OFF

```

1-3. Direct Mode Setup

DIRECT/PURE DIRECT

Room EQ ON OFF

3

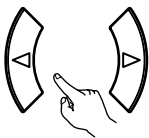

(Main unit)

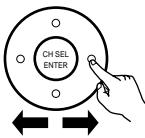

(Remote control unit)

Select ON or OFF.

4



(Main unit)



(Remote control unit)

Enter the setting .
The Auto Setup / Room EQ Menu reappears.

1-4. Setting the MIC Input Select

- Sets whether the setup microphone is connected to the PIN JACK (V.AUX L channel) connector or the MINI JACK (SETUP MIC) connector.

1

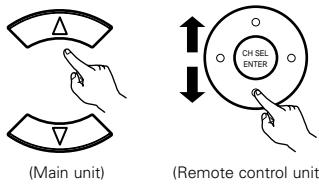

(Main unit) (Remote control unit)

Select "Mic Input Select" at the Auto Setup / Room EQ Menu.

```
*AutoSet/RoomEQ 1,4
Mic In Select
```

```
1. Auto Setup/Room EQ
1. Auto Setup
2. Room EQ Setup
3. Direct Mode Setup
4. Mic Input Select
5. Parameter Check

Exit
```

2

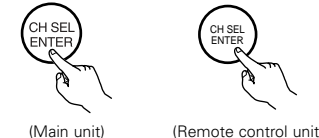

(Main unit) (Remote control unit)

Display the Mic Input Select screen.

```
*Mic In Select 1,4
Mic ▶
```

```
1-4. Mic Input Select

Mic ◀ : ▶ V.Aux L
```

3

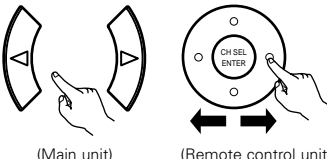

(Main unit) (Remote control unit)

Select the Mic input jack or V.AUX L jack.

4

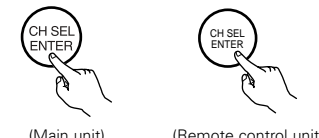

(Main unit) (Remote control unit)

Enter the setting.
The Auto Setup / Room EQ Menu reappears.

■ Specifications and Setup Procedure for Non-DENON Microphone Use for AVR-5805 Auto Setup and Room EQ Function

Required Microphone for DENON Auto-Setup Room EQ : Product name Countryman B3.

Required Microphone Amplifier Specification for DENON Auto-Setup Room EQ.

- Gain : 29 dB
- Frequency Response : 10 ~ 30 kHz Full Flat (Ex : Rane MS1b)

Microphone Placement

- Set the microphone using microphone stand, or other method, at the prime listening position.
- Point the top of the microphone toward the ceiling.
- Adjust the height so that the top of microphone to matches the height of your ear when sitting.

Microphone Amplifier Gain Setting using Sound Level Meter and RMS Volt Meter

First you will need to adjust the " microphone amplifier gain".

- (1) Connect the all speakers and the video monitor (for the on-screen display) with the AVR-5805
- (2) Connect the microphone with the microphone amplifier
- (3) Turn on the AVR-5805 and the "microphone amplifier"
- (4) Turn on the "Phantom Supply" on the microphone amplifier

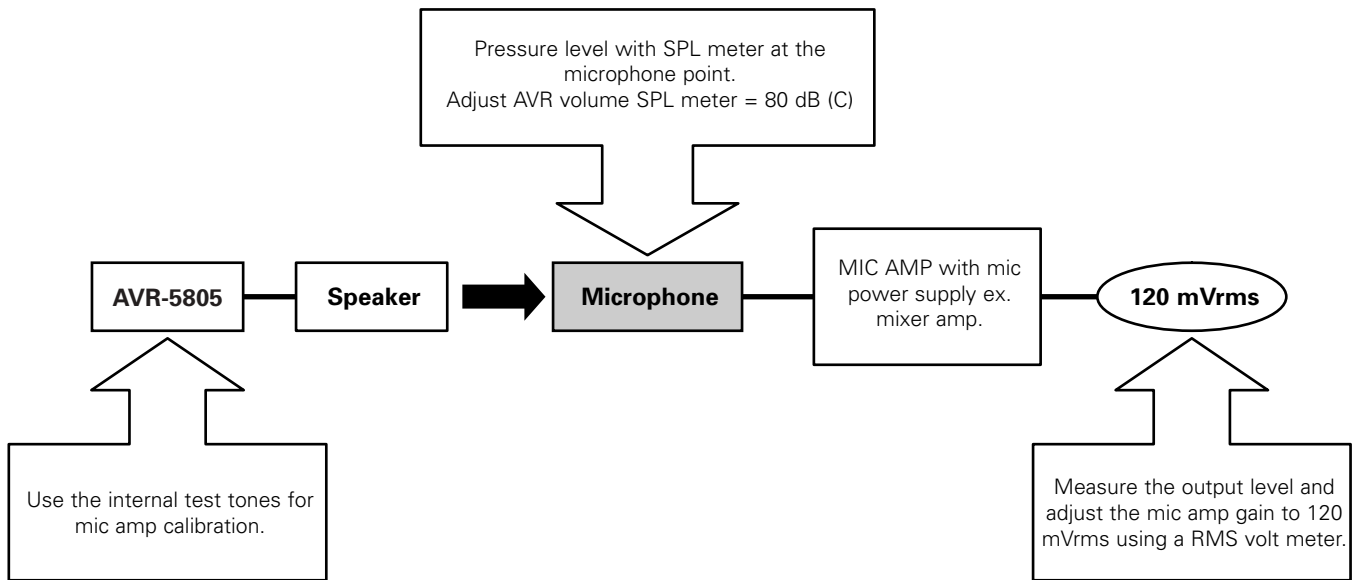

- (5) Set the Parameter "Test Tone" to "Manual" and "Test Tone Start" to "Yes" at "2-4. Channel Level". (See pages 51, 52)
- (6) Once the test tone for Front Left (FL) speaker starts, check the Sound Pressure Level at the Listening Position with an SPL Meter. You do not have to check any of the other channels.
- (7) Adjust the "Main Volume" so that the Sound Pressure Level measures 80 dB (C-weighted)
- (8) Once the "Main Volume" as been set, connect the output of microphone amplifier to the RMS Volt Meter
- (9) Adjust the "microphone amplifier's gain" as the RMS Volt Meter becomes about 120 [mV RMS]
- (10) Once set, exit out of "System Setup" and turn off the AVR-5805
- (11) Connect the output of the microphone amplifier to the AVR-5805's front panel "V.AUX" Left channel audio input-located behind Trap Door
- (12) Change the setting to "V.AUX L" at "1-4. Mic Input Select". (See pages 42, 43)
- (13) Start "Auto Setup". (See pages 33-39)

1-5. Check the Parameter

- The results of the measured items can be checked.
- The EQ parameters that were set in Auto Setup can be checked.
- This item is automatically displayed, after the measurement result of the "Auto Setup / Room EQ" is decided.

1



(Main unit)

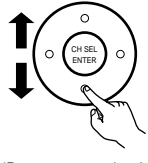

(Remote control unit)

Select "Parameter Check" at the Auto Setup / Room EQ Menu.

15

*AutoSet/RoomEQ
Parameter Check

1. Auto Setup/Room EQ

1. Auto Setup
2. Room EQ Setup
3. Direct Mode Setup
4. Mic Input Select
5. Parameter Check

Exit

2



(Main unit)



(Remote control unit)

Display the Parameter Check screen.

15

*ParameterCheck
SP Config. Check

1-5. Parameter Check

- Speaker Config. Check
- Delay Time Check
- Channel Level Check
- Crossover Freq. Check
- EQ Parameter Check

Restore Yes

Exit

3

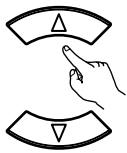

(Main unit)

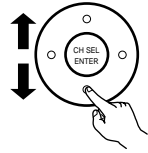

(Remote control unit)

Select the items.

4



(Main unit)



(Remote control unit)

Press the ENTER button and display the verification screen.
For instructions on checking the results of each item, see page 38.

5

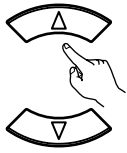

(Main unit)

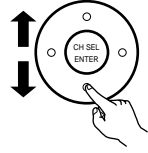

(Remote control unit)

EQ parameters can be checked here.
Select "EQ Parameter Check" at the Parameter Check screen.

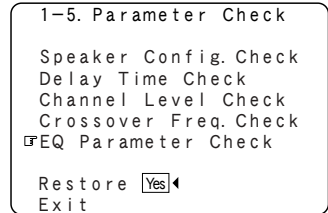
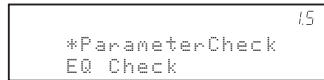

6



(Main unit)



(Remote control unit)

Display the EQ Parameter Check screen.

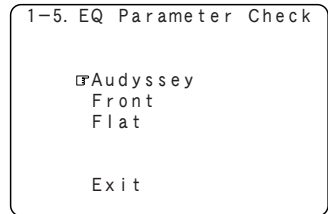
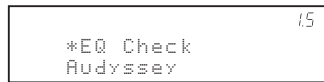

7

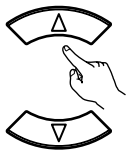

(Main unit)

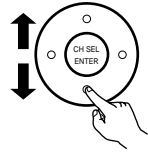

(Remote control unit)

Select the Equalizer curve.

8



(Main unit)



(Remote control unit)

Display the parameter screen.
The display is only an approximate picture of the response and that correction is happening at all frequencies.

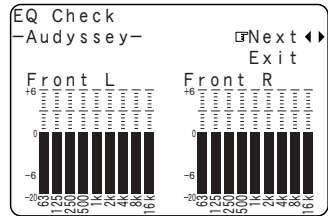
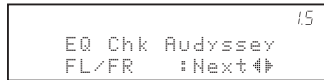

9

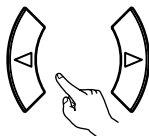

(Main unit)

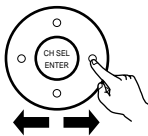

(Remote control unit)

Select the speaker channel.

10

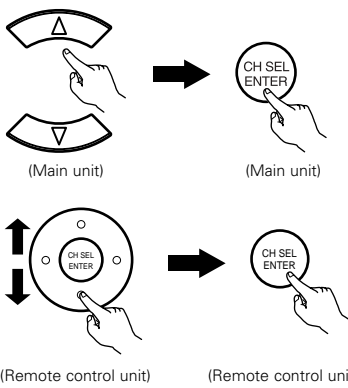

If the check ends, select "Exit" and press the ENTER button.
The EQ Parameter Check screen reappears.

```
EQ Chk Audyssey 15
Exit
```

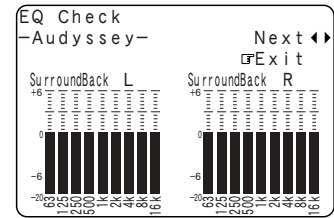

11

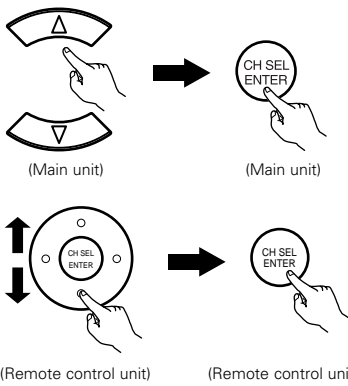

Select "Exit" and press the ENTER button at the EQ Parameter Check screen.
The Parameter Check screen reappears.

```
*EQ Check 15
Exit
```

```
1-5. EQ Parameter Check

Audyssey
Front
Flat

Exit
```

12

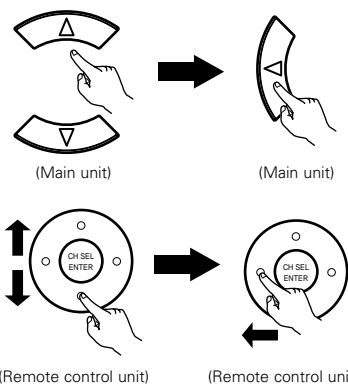

The results of the "Auto Setup" procedure can be reset even if the settings have been changed after performing the "Auto Setup" procedure.
Select "Restore Yes ◀" then press the Cursor left button.

```
*ParameterCheck 15
Restore
```

```
1-5. Parameter Check

Speaker Config. Check
Delay Time Check
Channel Level Check
Crossover Freq. Check
EQ Parameter Check

Restore Yes ◀
Exit
```

13

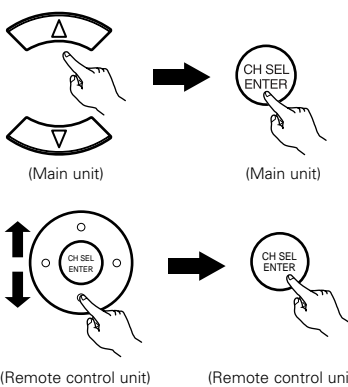

Select "Exit" and press the ENTER button at the Parameter Check screen.
The Auto Setup / Room EQ Menu reappears.

```
*ParameterCheck 15
Exit
```

```
1-5. Parameter Check

Speaker Config. Check
Delay Time Check
Channel Level Check
Crossover Freq. Check
EQ Parameter Check

Restore Yes ◀
Exit
```

14

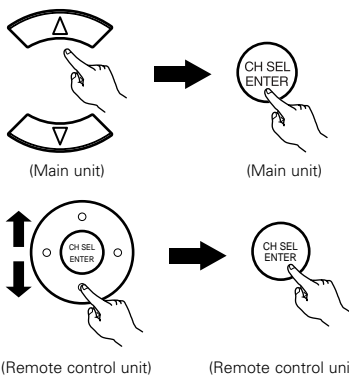

Select "Exit" and press the ENTER button at the Auto Setup / Room EQ Menu screen.
The System Setup Menu reappears.

```
*AutoSet/RoomEQ 10
Exit
```

1. Auto Setup/Room EQ
1. Auto Setup
 2. Room EQ Setup
 3. Direct Mode Setup
 4. Mic Input Select
 5. Parameter Check
- ☑Exit

2

Setting the Speaker Setup

- If the "Auto Setup" procedure has already been performed, there is no need to make this setting.
- Perform this setting if you wish to make the settings for your speaker systems manually.

1

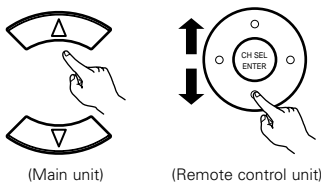

Select "Speaker Setup" at the System Setup Menu.

```
*System Setup 2
Speaker Setup
```

- System Setup Menu**
1. Auto Setup/Room EQ
 - ☑2. Speaker Setup
 3. Audio Input Setup
 4. Video Setup
 5. Advanced Playback
 6. Zone Setup
 7. Option Setup
 - Exit

2

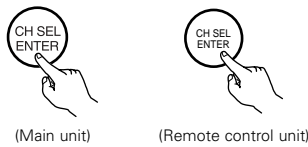

Display the Speaker Setup Menu screen.

```
*Speaker Setup 2.1
Speaker Config.
```

2. Speaker Setup
- ☑1. Speaker Config.
 2. Subwoofer Setup
 3. Delay Time
 4. Channel Level
 5. Crossover Frequency
 6. Surround Sp Setup
 7. THX Audio Setup
 - Exit

2-1. Setting the type of speakers

- The composition of the signals output to each channels and the frequency response are adjusted automatically according to the combination of speakers actually being used.

1

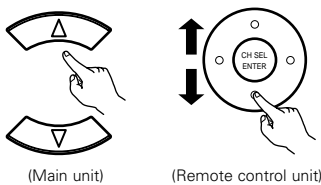

Select "Speaker Config." at the Speaker Setup Menu.

```
*Speaker Setup 2.1
Speaker Config.
```

2. Speaker Setup
- ☑1. Speaker Config.
 2. Subwoofer Setup
 3. Delay Time
 4. Channel Level
 5. Crossover Frequency
 6. Surround Sp Setup
 7. THX Audio Setup
 - Exit

2

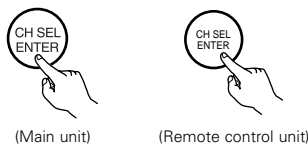

Display the Speaker Config. screen.

3

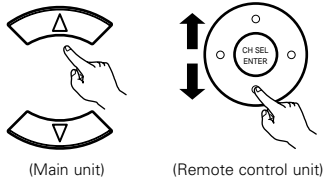

Set whether speakers are connected or not and, if so, their size parameters.

① Select the speaker.

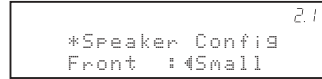
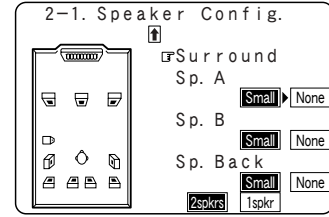
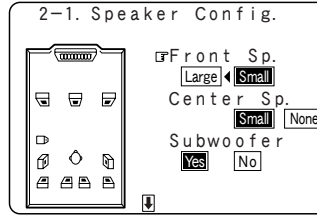

② Select the parameter.

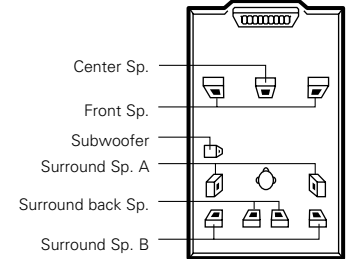
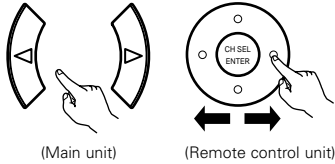

4

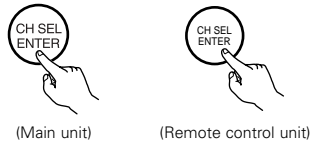

ENTER the setting.

The Speaker Setup Menu reappears.

NOTE:

- Select "Large" or "Small" not according to the actual size of the speaker but according to the speaker's capacity for playing low frequency (bass sound below the frequency set for the Crossover Frequency) signals. If you do not know, try comparing the sound at both settings (setting the volume to a level low enough so as not to damage the speakers) to determine the proper setting.

Parameters

Large.....Select this when using speakers that can fully reproduce deep bass well below 80 Hz.

SmallSelect this when using speakers that are not capable of handling deep bass well below 80 Hz. Most home theater main and surround speakers perform best when configured as SMALL. Deep bass content in any channel with a SMALL speaker is routed to the subwoofer(s).

NoneSelect this when no speakers are installed.

Yes/No.....Select "Yes" when a subwoofer is installed, "No" when a subwoofer is not installed.

2 spkrs/1 spkr.....Select the number of speakers to be used for the surround back channel.

- ※ A subwoofer with sufficient low frequency playback capability can better handle deep bass than most main and surround speakers, and the system's overall performance will be greatly enhanced when SMALL is set for the main (front) and surround speakers.
- ※ To take full advantage of the performance of the Home THX certified speaker systems, set the front, center and surround speaker size parameters to "Small" and the subwoofer to "Yes".
- ※ For the majority of speaker system configurations, using the SMALL setting for all main and surround speakers and connected subwoofer(s) set to ON will yield the best results.
- ※ When "Front" is set to "Small", "Subwoofer" is automatically set to "Yes", and when "Subwoofer" is set to "No", "Front" is automatically set to "Large".

2-2. Setting the low frequency distribution

- Set the subwoofer mode according to the speaker system being used.
- Select the play mode that provides bass reproduction with body.

1

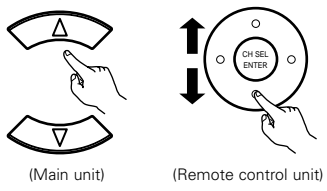

(Main unit) (Remote control unit)

Select "Subwoofer Setup" at the Speaker Setup Menu.

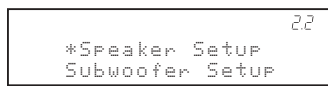

```

22
*Speaker Setup
Subwoofer Setup
    
```

2. Speaker Setup

1. Speaker Config.
2. Subwoofer Setup
3. Delay Time
4. Channel Level
5. Crossover Frequency
6. Surround Sp Setup
7. THX Audio Setup
- Exit

2

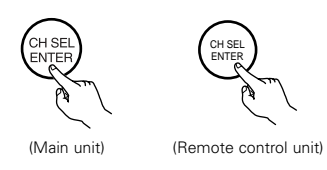

(Main unit) (Remote control unit)

Display the Subwoofer Setup screen.

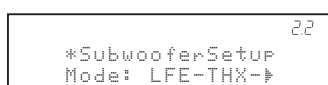

```

22
*SubwooferSetup
Mode: LFE-THX-
    
```

2-2. Subwoofer Setup

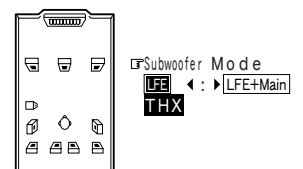

3

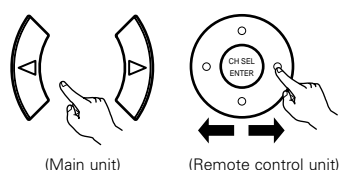

(Main unit) (Remote control unit)

Select the setting.

LFE-THX- : For any channel(s) that are set to LARGE, low frequencies in that channel's corresponding source are directed to that loudspeaker only. Low frequencies that are directed to the subwoofer(s) are from the program source LFE channel, and from other channels where the speakers are set to SMALL. THX is recommended in this play mode so that bass interference is less likely to occur in the room.

LFE+Main : Low frequencies from speaker channels that have been set to LARGE are reproduced from those speakers as well as from the subwoofer(s). Depending upon the characteristics of the LARGE main speakers, this mode may provide a more even low frequency response throughout the listening room.

4

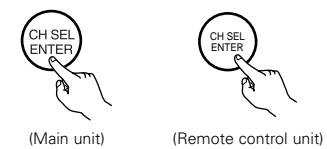

(Main unit) (Remote control unit)

Enter the setting.
The Speaker Setup Menu reappears.

NOTES:

— Assignment of low frequency signal range (2-1) —

- The only signals produced from the subwoofer channel are LFE signals (during playback of Dolby Digital or DTS signals) and the low frequency signal range of channels set to "Small" in the setup menu. The low frequency signal range of channels set to "Large" are produced from those channels.

— Subwoofer Setup (2-2) —

- The subwoofer mode setting is only valid when and "Yes" is set for the subwoofer in the "2-1. Speaker Configuration" settings (see pages 46, 47).
- When the input signal is analog or a PCM signal not including LFE signals, if "LFE-THX-" is selected, the low frequency component is not output from the subwoofer. To output the subwoofer channel, select "LFE+Main".

2-3. Setting the Delay Time

- Input the distance between the listening position and the different speakers to set the delay time for the surround mode.
- Two surround back speakers are required to use the THX Ultra2 Cinema, THX Music modes and THX Games mode.

Set the surround back speakers so that the distance to the listening position is the same for both the left and right speakers.

It is also recommended that the deviations of the distance from the listening position to L and R channel speakers (front left (FL) and front right (FR), surround left (SL) and surround right (SR), surround back left (SBL) and surround back right (SBR)) is less than 2 ft (60 cm).

Preparations:

Measure the distances between the listening position and the speakers (L1 to L6 on the diagram at the right).

- L1: Distance between center speaker and listening position
- L2: Distance between front speakers and listening position
- L3: Distance between surround speakers and listening position
- L4: Distance between surround back speakers and listening position
- L5: Distance between subwoofer and listening position
- L6: Distance between surround back L and surround back R

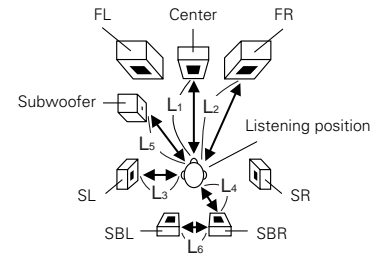

1 Select "Delay Time" at the Speaker Setup Menu.

(Main unit)

(Remote control unit)

```
*Speaker Setup          2.3
Delay Time
```

2. Speaker Setup

1. Speaker Config.
2. Subwoofer Setup
3. Delay Time
4. Channel Level
5. Crossover Frequency
6. Surround Sp Setup
7. THX Audio Setup
- Exit

2 Display the Delay Time screen.

(Main unit)

(Remote control unit)

```
*Delay Time          2.3
Meters < : > Feet
```

2-3. Delay Time

Set The Distance To Each Speakers

Do You Prefer In Meters? / In Feet?

Meters < : > Feet

3 Select the desired unit, meters or feet.

(Main unit)

(Remote control unit)

2-3. Delay Time

Set The Distance To Each Speakers

Do You Prefer In Meters? / In Feet?

Meters < : > **Feet**

Example: When "Feet" is selected

4 Once "Meters" or "Feet" is selected in step 3, the Delay Time screen appears automatically.

```
*Delay Time          2.3
FL : <12.0ft>
```

```
2-3. Delay Time
Step < 1ft >
Default Yes <
FL < 12.0ft >
FR 12.0ft
C 12.0ft
SW 12.0ft
```

```
2-3. Delay Time
SL A < 10.0ft >
SR A 10.0ft
SL B 10.0ft
SR B 10.0ft
SBL 10.0ft
SBR 10.0ft
```

5 Select the speaker to be set. The picture of the speaker selected blinks.

(Main unit)

(Remote control unit)

6

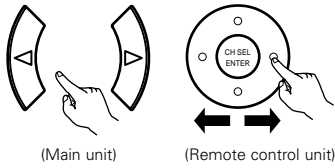

Set the distance between the center speaker and listening position.
 The distance changes in units of 0.1 foot (0.03 meters) or 1 foot (0.3 meters) each time the button is pressed. Select the value closest to the measured distance.

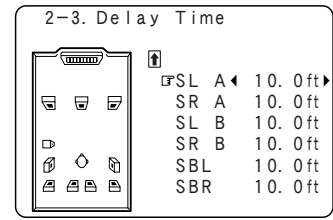
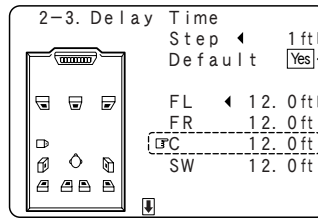

Example: When the distance is set to 12 feet for the center speaker

- ※ If "Yes" is selected for "Default", the settings are automatically reset to the default values.
- ※ When "Step" is selected, you can select the unit of "1ft (0.1m)" or "0.1ft (0.01m)".

Please note that the difference of distance for every speaker should be 20 ft (6.0 m) or less. If you set an invalid distance, a CAUTION notice, such as screen right will appear. In this case, please relocate the blinking speaker(s) so that its distance is no larger than the value shown in highlighted line.

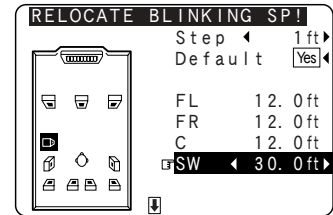

7

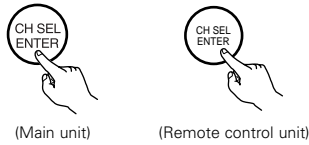

Enter the setting.
 The Speaker Setup Menu reappears.
 The AVR-5805 automatically sets the optimum surround delay time for the listening room.

2-4. Setting the Channel Level

- Use this setting to adjust so that the playback level between the different channels is equal.
- From the listening position, listen to the test tones produced from the speakers to adjust the level.
- The level can also be adjusted directly from the Remote control unit. (For details, see pages 134, 135.)
- The level of each channel should be adjusted to 75 dB (C-weighted, slow meter mode) on a sound level meter at the listening position.
If a sound level meter is not available adjust the channels by ear so the sound levels are the same. Because adjusting the subwoofer level test tone by ear is difficult, use a well known music selection and adjust for natural balance.

1

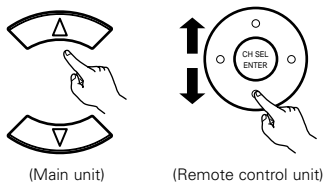

(Main unit) (Remote control unit)

Select "Channel Level" at the Speaker Setup Menu.

```

                2.4
    *Speaker Setup
    Channel Level
    
```

```

2. Speaker Setup
1. Speaker Config.
2. Subwoofer Setup
3. Delay Time
4. Channel Level
5. Crossover Frequency
6. Surround Sp Setup
7. THX Audio Setup
Exit
    
```

2

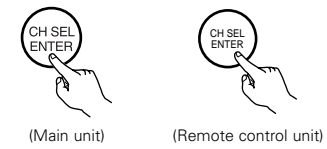

(Main unit) (Remote control unit)

Display the Channel Level screen.

```

                2.4
    *Channel Level
    T.Tone: Auto
    
```

```

2-4. Channel Level
Test Tone [Auto]◀:▶[Manual]
Test Tone Start [Yes]◀
Level Clear [Yes]◀
    
```

3

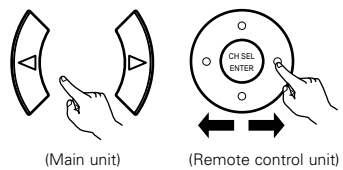

(Main unit) (Remote control unit)

Select the mode.
Select "Auto" or "Manual".

```

                2.4
    *Channel Level
    T.Tone: Auto
    
```

```

2-4. Channel Level
Test Tone [Auto]◀:▶[Manual]
Test Tone Start [Yes]◀
Level Clear [Yes]◀
    
```

Auto :

Adjust the level while listening to the test tones produced automatically from each speaker.

Example: When the "Auto" mode is selected

Manual :

Select the speaker from which you want to produce the test tone to adjust the level.

4

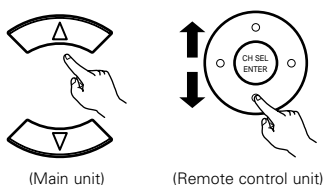

(Main unit) (Remote control unit)

Select "Test Tone Start".

```

                2.4
    *Channel Level
    Tone Start:Yes
    
```

```

2-4. Channel Level
Test Tone [Auto]◀:▶[Manual]
Test Tone Start [Yes]◀
Level Clear [Yes]◀
    
```

5

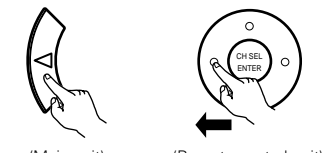

(Main unit) (Remote control unit)

Select "Yes".

```

2-4. Channel Level
Test Tone [Auto]◀:▶[Manual]
Test Tone Start [Yes]◀
Level Clear [Yes]◀
    
```

6

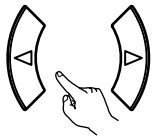

(Main unit)

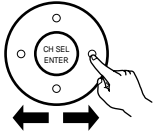

(Remote control unit)

- a. When "Auto" mode is selected:
 Test tones are automatically emitted from each speaker.
 The test tones are emitted from each speaker in the following order, at 4-second intervals the first time and second time around, 2-second intervals the third time around and on:

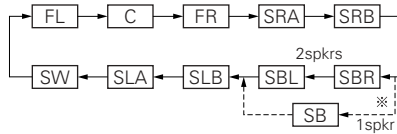

- ※ When the surround back speaker setting is set to "1spkr" for "2-1. Speaker Configuration", this is set to "SB".

Use the Cursor left and right buttons to adjust all the speakers to the same volume.
 The volume can be adjusted between -12 dB and +12 dB in units of 0.5 dB.

- b. When "Manual" mode is selected:

- ① Select the speaker.

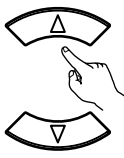

(Main unit)

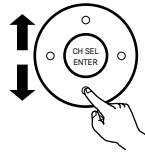

(Remote control unit)

- ② Adjust all the speakers to the same volume.

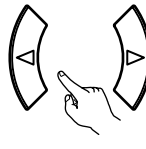

(Main unit)

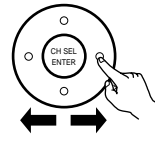

(Remote control unit)

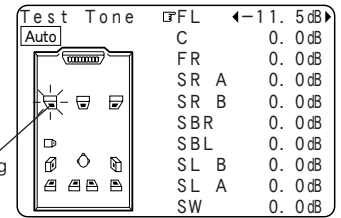

Flashing

Example: When the volume is set to -11.5 dB while the test tone is being produced from the Front Lch speaker

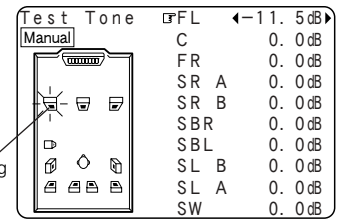
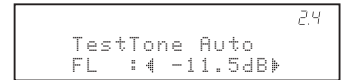

Flashing

Example: "Manual" mode is selected.

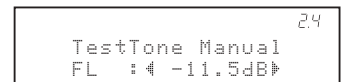

7



(Main unit)



(Remote control unit)

Enter the setting.
 The Channel Level screen reappears.

- ※ To cancel the settings, press the Cursor down button to select "Level Clear" and "Yes" on the Channel Level screen, then make the settings again.

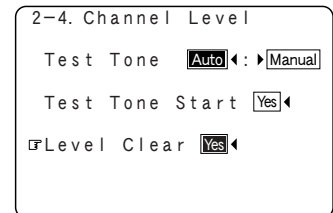

NOTES:

- When adjusting the level of an active subwoofer system, you may also need to adjust the subwoofer's own volume control.
- When you adjust the channel levels while in the SYSTEM SETUP CHANNEL LEVEL mode, the channel level adjustments made will affect all surround modes. Consider this mode a Master Channel Level adjustment mode.
- After you have completed the SYSTEM SETUP CHANNEL LEVEL adjustments, you can then activate the individual surround modes and adjust channel levels that will be remembered for each of those modes. Then, whenever you activate a particular surround sound mode, your preferred channel level adjustments for just that mode will be recalled. Check the instructions for adjusting channel levels within each surround mode. (See pages 134, 135)
- You can adjust the channel levels for each of the following surround modes: PURE DIRECT/DIRECT, STEREO, DOLBY/DTS SURROUND, HOME THX CINEMA, 9CH STEREO, WIDE SCREEN, SUPER STADIUM, ROCK ARENA, JAZZ CLUB, CLASSIC CONCERT, MONO MOVIE, VIDEO GAME and MATRIX.
- When using either surround speakers A or B, or when using surround speakers A and B at the same time, be sure to adjust the balance of playback levels between each channel for the various selections of "A or B" and "A and B".

2-5. Setting the Crossover Frequency

- Set the crossover frequency according to the low frequency response characteristics of the various (front, center, surround and surround back) speaker systems.
- If a connected main or surround loudspeaker has a specified -3 dB low frequency response rolloff, adjust the crossover frequency for that speaker to match the specified low frequency response limit – e.g. 80 Hz.
- When a speaker is set to SMALL, low frequencies in that channel that are below the crossover frequency are directed to the system's subwoofer(s), or to speakers that are set to LARGE, for systems with no connected subwoofer(s).

1

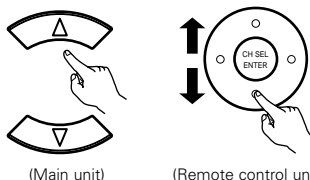

(Main unit) (Remote control unit)

Select the "Crossover Frequency" at the Speaker Setup Menu.

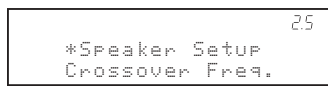

2. Speaker Setup

1. Speaker Config.
2. Subwoofer Setup
3. Delay Time
4. Channel Level
5. Crossover Frequency
6. Surround Sp Setup
7. THX Audio Setup
- Exit

2

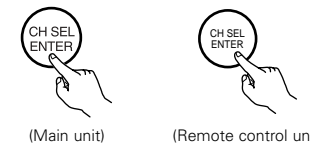

(Main unit) (Remote control unit)

Display the Crossover Frequency screen.

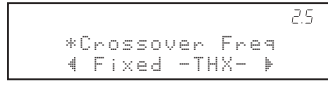

2-5. Crossover Frequency

◀ Fixed ▶
-THX-

3

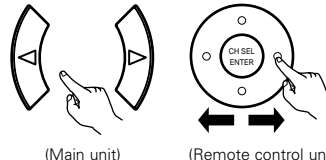

(Main unit) (Remote control unit)

Select the frequency.

FIXED -THX- :
Set to the THX rated 80 Hz crossover frequency.

VARIABLE 40, 60, 80, 90, 100, 110, 120, 150, 200, 250 Hz :
Set as desired according to your speakers' bass playback ability.

Advanced :
The crossover frequency can be set individually for the different speakers. (See page 54)

4

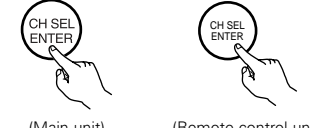

(Main unit) (Remote control unit)

Enter the setting.
The Speaker Setup Menu reappears.

※ If "LFE+Main" is set at "2-2. Subwoofer Setup", "SW:LFE+Main" (see page 48) is displayed at the top right of the screen.

2-5. Crossover Frequency

SW:LFE+Main

◀ Fixed ▶
-THX-

NOTES:

- The crossover frequency is set to 80 Hz in the HOME THX CINEMA mode.
- We recommend using with the crossover frequency set to "FIXED -THX-", but depending on the speaker, setting it to a different frequency may improve frequency response near the crossover frequency.
- The crossover frequency mode is valid only when subwoofer is set to ON, and when one or more speakers are set to SMALL, as described in section "2-1. Speaker Configuration" settings.

■ Setting the crossover frequency individually for the different channels

1

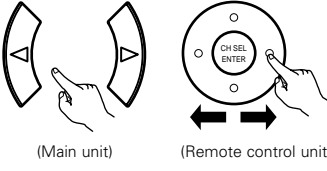

(Main unit) (Remote control unit)

Select "Advanced" at the Crossover Frequency screen.

2.5

*Crossover Freq
◀ Advanced ▶

2-5. Crossover Frequency

◀ Advanced ▶

Front	Small	: 80Hz ▶
Center	Small	: 80Hz ▶
Surround A	Small	: 80Hz ▶
Surround B	Small	: 80Hz ▶
S. Back	Small	: 80Hz ▶
LFE		80Hz ▶

2

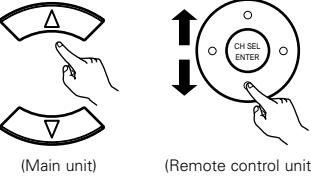

(Main unit) (Remote control unit)

Select the speaker to be set.

2.5

*Crossover Freq
Front : 80Hz ▶

2-5. Crossover Frequency

◀ Advanced ▶

Front	Small	: 80Hz ▶
Center	Small	: 80Hz ▶
Surround A	Small	: 80Hz ▶
Surround B	Small	: 80Hz ▶
S. Back	Small	: 80Hz ▶
LFE		80Hz ▶

3

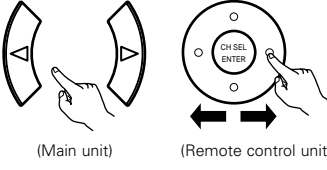

(Main unit) (Remote control unit)

Select the frequency.

2.5

*Crossover Freq
Front : 100Hz ▶

2-5. Crossover Frequency

◀ Advanced ▶

Front	Small	: 100Hz ▶
Center	Small	: 80Hz ▶
Surround A	Small	: 80Hz ▶
Surround B	Small	: 80Hz ▶
S. Back	Small	: 80Hz ▶
LFE		80Hz ▶

NOTES:

- If "LFE-THX-" is selected at "2-2. Subwoofer Setup", the frequencies can only be selected for speakers set to "Small" at "2-1. Speaker Configuration".

2-5. Crossover Frequency

◀ Advanced ▶

Front	Large	:
Center	Small	: 40Hz ▶
Surround A	Small	: 80Hz ▶
Surround B	None	:
S. Back	Small	: 120Hz ▶
LFE		80Hz ▶

- If "LFE+Main" is set at "2-2. Subwoofer Setup", the frequencies can be selected regardless of the speaker size setting.

2-6. Selecting the Surround Speakers for the different surround modes

- This Menu is displayed when both surround speakers A and B are used.
- At this screen preset the surround speakers to be used in each surround modes.

1

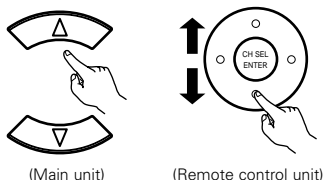

(Main unit) (Remote control unit)

Select "Surround Sp Setup" at the Speaker Setup Menu.

```
*Speaker Setup 26
Surr SP Setup
```

2. Speaker Setup

1. Speaker Config.
2. Subwoofer Setup
3. Delay Time
4. Channel Level
5. Crossover Frequency
6. Surround Sp Setup
7. THX Audio Setup

Exit

2

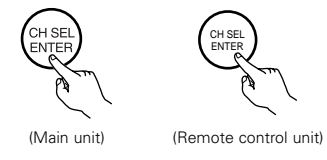

(Main unit) (Remote control unit)

Display the Surround Sp Setup screen.

```
*Surr Sp Setup 26
CINEMA : ◀ A ▶
```

2-6. Surround Sp Setup

THX/DOLBY/DTS	A ▶	B	A+B
CINEMA	A ▶	B	A+B
MUSIC	A ▶	B	A+B
GAME	A ▶	B	A+B
WIDE SCREEN	A ▶	B	A+B
9CH STEREO	A ▶	B	A+B
DSP SIMULATION	A ▶	B	A+B
MULTI CH MODE	A ▶	B	A+B

3

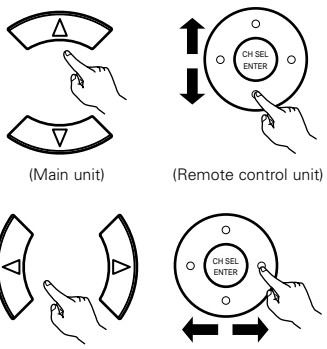

(Main unit) (Remote control unit)

① To select the surround mode

② To select the surround speaker

- A** : When surround speakers A is used.
- B** : When surround speakers B is used.
- A+B** : When both surround speakers A and B are used.

4



(Main unit) (Remote control unit)

Enter the setting.
The Speaker Setup Menu reappears.

- ※ For the "WIDE SCREEN" and "9CH STEREO" DSP simulation modes, the surround speakers can be set separately.
- ※ See pages 60, 61 for setting the surround speaker when the "Analog" mode is selected at "3-2. EXT.IN Setup".

About Speaker type setting when using both surround speakers A and B

- If "Small" is set for either surround speakers A or B, the output is the same as when "Small" is set for both A and B.

2-7. Setting the THX Audio Setup

[1] Settings for using a THX Ultra2 compatible subwoofer

- Make these settings when "Yes" is selected for the subwoofer in the "2-1. Speaker Configuration" settings. There is not displayed when "No" selected. (pages 46, 47)

1

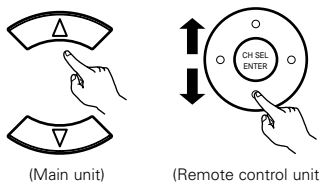

(Main unit) (Remote control unit)

Select "THX Audio Setup" at the Speaker Setup Menu.

2.7

*Speaker Setup
THX Audio Setup

2. Speaker Setup

1. Speaker Config.
2. Subwoofer Setup
3. Delay Time
4. Channel Level
5. Crossover Frequency
6. Surround Sp Setup
7. THX Audio Setup
- Exit

2

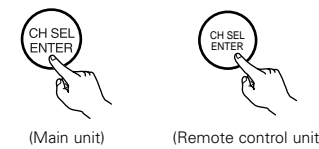

(Main unit) (Remote control unit)

Display the THX Audio Setup screen.

2.7

*THX AudioSetup
Boundary Gain

2-7. THX Audio Setup

Boundary Gain Compensation

Surround Back Speaker Position

Exit

3

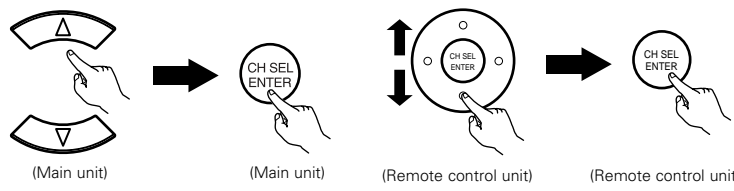

(Main unit) (Main unit) (Remote control unit) (Remote control unit)

Select "Boundary Gain Compensation", then press the ENTER button.

4

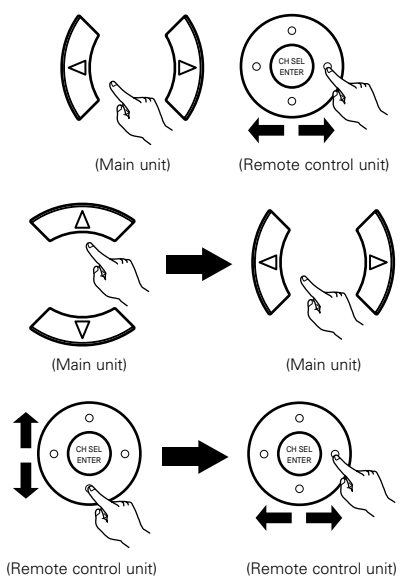

(Main unit) (Remote control unit)

(Main unit)

(Remote control unit) (Remote control unit)

When using a THX Ultra2 compatible subwoofer or subwoofer that frequency response extends to 20 Hz, select "Yes". Otherwise select "No".

2.7

Boundary Gain
THX U2 SW: No

2-7. THX Audio Setup
Do You Have
 A THX Ultra2 Subwoofer
(Or Sub That
Extends To 20Hz) ?
Yes ◀ : ▶ No

- When "Yes" is selected "Boundary Gain Compensation" can be selected and the compensation set to "OFF".
- If the bass sound seems too strong Set "Boundary Gain Compensation" to "ON". This activates a filter that gently reduces very deep bass below 55 Hz to provide the flattest overall deep bass response. Select ON or OFF according to how strong you prefer the deep bass response to be.

2.7

Boundary Gain
THX U2 SW: Yes▶

2-7. THX Audio Setup
Do You Have
 A THX Ultra2 Subwoofer
(Or Sub That
Extends To 20Hz) ?
Yes ◀ : ▶ No

Boundary Gain Compensation
ON ◀ : ▶ OFF

5

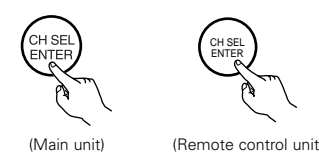

(Main unit) (Remote control unit)

Press the ENTER button to return to the THX Audio Setup screen.

[2] Surround Back Speaker Position Settings

- When two surround back speakers have been set in "2-1. Speaker Configuration" (pages 46, 47), set the distance of the speakers. There is not displayed when "1spkr" selected.
- This setting is necessary to achieve the optimum effect in the THX Surround EX, THX Ultra2 Cinema, THX Music modes and THX Games mode. It is recommended that SBL/SBR speakers are placed together as close as possible.

1

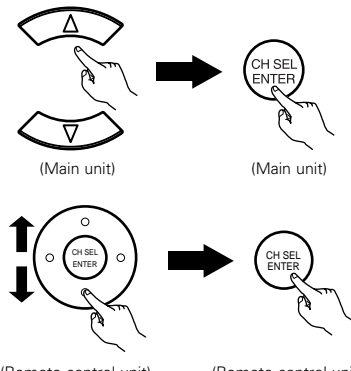

Select "Surround Back Speaker Position" at the THX Audio Setup screen and press the ENTER button.

```

                2.7
    *THX AudioSetup
    SB Sp Position
    
```

```

2-7. THX Audio Setup
Boundary Gain
Compensation
☑Surround Back
Speaker Position
Exit
    
```

2

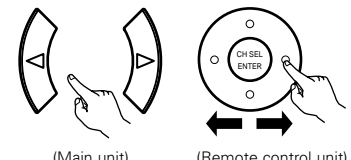

Select the settings according to the distances of the two surround back speakers. (page 49)

```

                2.7
    SB Sp Position
    ◀ 0ft to 1ft ▶
    
```

```

2-7. THX Audio Setup
Set The distance
Between SBL/SBR
◀ 0ft to 1ft ▶
(0m to 0.3m)
    
```

3

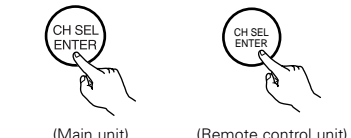

Press the ENTER button to return to the THX Audio Setup screen.

4

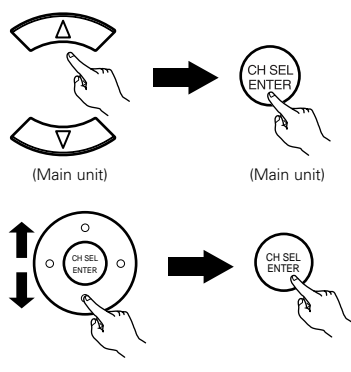

Select "Exit" and press the ENTER button to return to the Speaker Setup Menu screen.

```

                2.7
    *THX AudioSetup
    Exit
    
```

```

2-7. THX Audio Setup
Boundary Gain
Compensation

Surround Back
Speaker Position
☑Exit
    
```

5

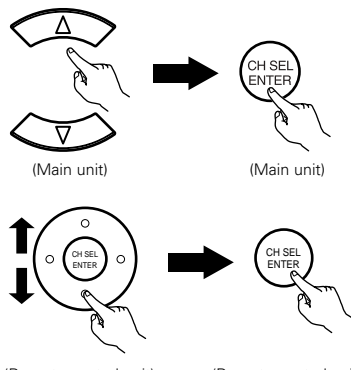

Select "Exit" and press the ENTER button at the Speaker Setup Menu screen. The System Setup Menu reappears.

```

                2.0
    *Speaker Setup
    Exit
    
```

```

2. Speaker Setup
1. Speaker Config.
2. Subwoofer Setup
3. Delay Time
4. Channel Level
5. Crossover Frequency
6. Surround Sp Setup
7. THX Audio Setup
☑Exit
    
```

3

Setting the Audio Input Setup

- Make the audio-related settings.

1

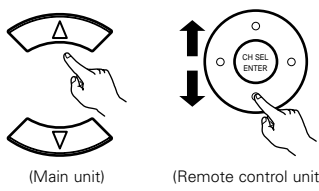

(Main unit) (Remote control unit)

Select "Audio Input Setup" at the System Setup Menu.

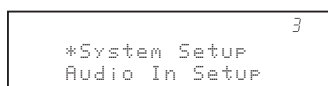

System Setup Menu

1. Auto Setup/Room EQ
2. Speaker Setup
3. Audio Input Setup
4. Video Setup
5. Advanced Playback
6. Zone Setup
7. Option Setup
- Exit

2

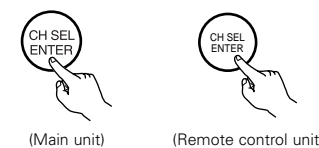

(Main unit) (Remote control unit)

Display the Audio Input Setup Menu screen.

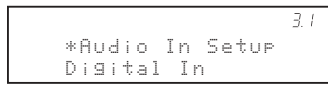

3. Audio Input Setup

1. Digital In Assign
2. EXT. IN Setup
3. Input Function Lev.
4. Function Rename
5. IEEE1394 Assign
6. IEEE1394 Auto Func.
7. Tuner Presets
- Exit

3-1. Setting the Digital In Assignment

- This setting assigns the digital input jacks of the AVR-5805 for the different input sources.

1

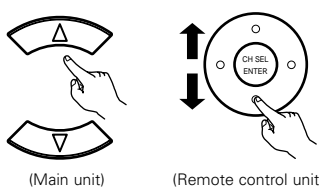

(Main unit) (Remote control unit)

Select "Digital In Assign" at the Audio Input Setup Menu.

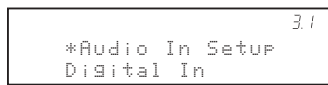

3. Audio Input Setup

1. Digital In Assign
2. EXT. IN Setup
3. Input Function Lev.
4. Function Rename
5. IEEE1394 Assign
6. IEEE1394 Auto Func.
7. Tuner Presets
- Exit

2

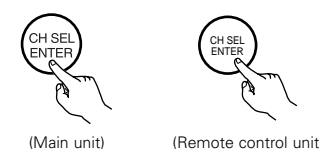

(Main unit) (Remote control unit)

Display the Digital In Assign screen.

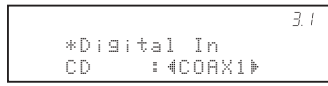

3-1. Digital In Assign

CD	: <COAX1>	Tap: OPT5
DVD	: COAX2	V.Aux: OPT6
VDP	: COAX3	
TV	: *COAX4	
DBS	: COAX5	
VCR-1	: OPT1	
VCR-2	: OPT2	
VCR-3	: OPT3	
VCR-4	: OPT4	Default Yes

3

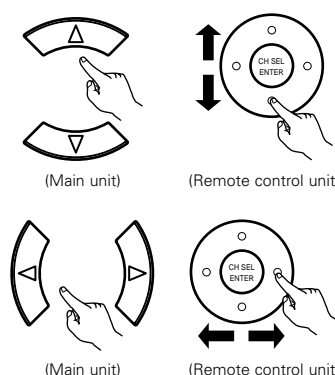

(Main unit) (Remote control unit)

Select the digital input jack to be assigned to the input source.

- ① Select the input source.
- ② Select the digital input jack.
 Select from among COAX 1 to 6, OPT 1 to 6.
 Select "OFF" for input sources for which no digital input jacks are used.
 It is not possible to select the same digital input jack for different input sources.
 If the same digital input jack is selected, the setting for the input source that was previously assigned switches to "OFF".
 The HDMI input terminal is displayed when it is assigned to the input source at "4-5. HDMI/DVI In Assign". (See pages 75, 76)
 ※ If "Yes" is selected for "Default", the settings are automatically reset to the default values.

4



(Main unit)



(Remote control unit)

Enter the setting.
The Audio Input Setup Menu reappears.

NOTES:

- The OPTICAL 3, 4 and 5 jacks on the AVR-5805's rear panel are equipped with an optical digital output jack for recording digital audio signals to a CD recorder, MD recorder, or other digital audio recording deck. Use this for digital recording between a digital audio source (stereo - 2 channel) and a digital audio recorder.
- Do not connect the output of the component connected to the OPTICAL 3 OUT jack on the AVR-5805's rear panel to any jack other than the OPTICAL 3 IN jack.
- Do not connect the output of the component connected to the OPTICAL 4 OUT jack on the AVR-5805's rear panel to any jack other than the OPTICAL 4 IN jack.
- Do not connect the output of the component connected to the OPTICAL 5 OUT jack on the AVR-5805's rear panel to any jack other than the OPTICAL 5 IN jack.
- "PHONO" and "TUNER" cannot be selected on the Digital In Assignment screen.

Refer to "DENON LINK connections". (See page 18)

3-2. Setting the EXT. IN Setup

- Set the method of playback of the analog input signal connected to the EXT.IN-1 (10 CH) and EXT.IN-2 (6 CH) terminal.

1

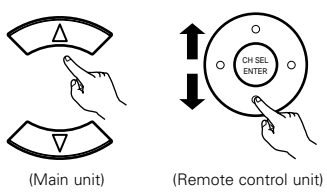

(Main unit) (Remote control unit)

Select "EXT.IN Setup" at the Audio Input Setup Menu.

```
*Audio In Setup 3.2
EXT.IN Setup
```

3. Audio Input Setup

- 1. Digital In Assign
- 2. EXT. IN Setup
- 3. Input Function Lev.
- 4. Function Rename
- 5. IEEE1394 Assign
- 6. IEEE1394 Auto Func.
- 7. Tuner Presets
- Exit

2

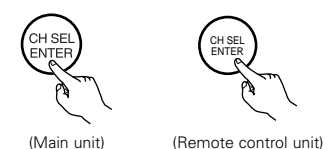

(Main unit) (Remote control unit)

Display the EXT.IN Setup screen.

```
*EXT.IN Setup 3.2
EXT.IN-1
```

3-2. EXT. IN Setup

- EXT. IN-1
- EXT. IN-2
- Exit

3

① Select the input terminal.

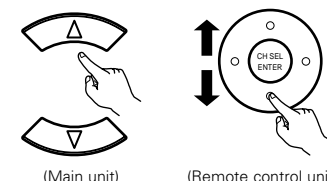

(Main unit) (Remote control unit)

② Switch to the setting screen.

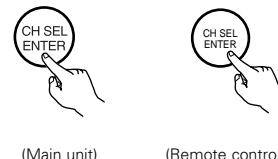

(Main unit) (Remote control unit)

4

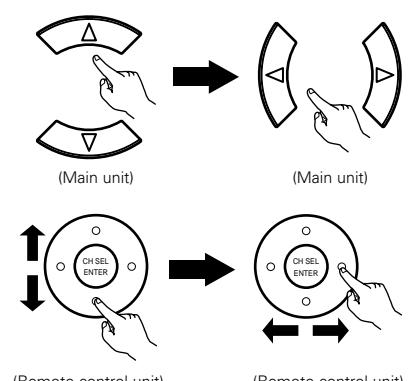

(Main unit) (Main unit)

(Remote control unit) (Remote control unit)

Select the item to be set (use the Cursor button to the up and down) then select the parameter (use the Cursor left and right buttons).

```
*EXT.IN-1 Setup 3.2
Mode : < DSP >
```

3-2. EXT. IN-1 Setup

- Mode < DSP >
- Surr. B < NOT USED >
- S. Back < NOT USED >
- SW Level < +15dB >
- Input ATT. < OFF >

- The items to be set differ as described below according to the selected input jack and the “Mode” selection.

Mode	EXT. IN-1 (10 CH)		EXT. IN-2 (6 CH)	
	DSP	ANALOG	DSP	ANALOG
Surr. B	NOT USED / USED	NOT USED / USED	-	-
S. Back	NOT USED, SBL/SBR, SB (SBL)	-	-	-
Surr. Sp	-	Surr.A / Surr.B / Surr.A+B	-	Surr. A / Surr. B / Surr. A+B
SW Level	0, +5, +10, +15 dB	0, +5, +10, +15 dB	0, +5, +10, +15 dB	0, +5, +10, +15 dB
Input ATT.	OFF, -6 dB	-	OFF, -6 dB	-

MODE :

- DSP** : The analog input signal is converted into a digital signal and undergoes DSP processing. System Setup settings (speaker configuration, channel delay, etc.) are reflected in the same way as for other input signals. The surround playback mode button functions.
- ANALOG** : The analog input signal is played without DSP processing. SW and center channel: Down-mixing is conducted by the analog circuit. Surround and surround back channels: Not output if “No” is selected at the speaker configuration. Channel delay: Not reflected.

S. Back :

Set when MODE is set to “DSP”. Select according to the specifications of the player being used. Also refer to the player’s operating instructions.

- NOT USED** : Select when neither SBL or SBR is connected.
- SB (SBL)** : Select when only one surround back channel (SBL) is connected.
- SBL/SBR** : Select when two surround back channels (SBL and SBR) are connected.

Surr. B :

Select according to the specifications of the player being used. Also refer to the player’s operating instructions.

- NOT USED** : Select when Surround B is not connected. The Surround A input signal is output to the Surround B output connector.
- USED** : Select when Surround B is connected. The playback in the MULTI CH DIRECT and MULTI CH IN is only possible when MODE is set to “DSP”.

Surr. Sp :

Set when MODE is set to “ANALOG”. Select according to the specifications of the player being used. Also refer to the player’s operating instructions.

- Surr. A** : Select when using surround speakers A.
- Surr. B** : Select when using surround speakers B.
- Surr. A+B** : Select when using both surround speakers A and B.

SW Level :

Select according to the specifications of the player being used. Also refer to the player’s operating instructions.

Set the level of playback of the analog input signal connected to the Ext.In Subwoofer. +15dB (default) recommended. (0, +5, +10 and +15 can be selected.)

INPUT ATT. :

Set when MODE is set to “DSP”. If the OVER LOAD indicator is displayed on the fluorescent tube, select “-6 dB”.

5

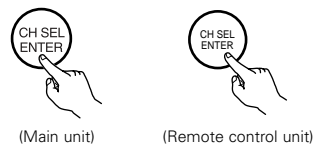

Enter the setting.
The EXT.IN Setup screen reappears.

6

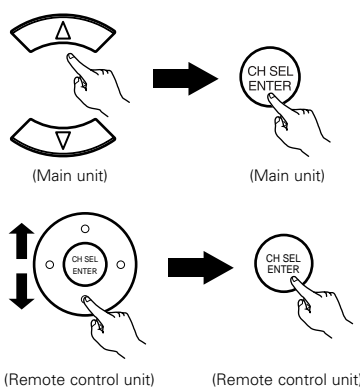

Select “Exit” and press the ENTER button to return to the Audio Input setup Menu screen.

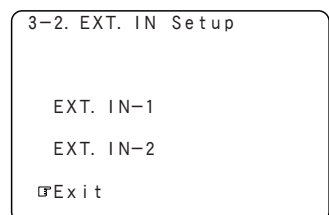
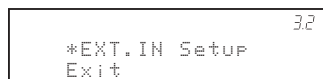

3-3. Setting the Input Function Level

- Correct the playback level of the different input sources.
- Adjust the playback levels of the devices connected to the different input sources to the same level to eliminate the need for adjusting the main volume each time the input source is switched.

1

(Main unit) (Remote control unit)

Select "Input Function Lev." at the Audio Input Setup Menu.

33

*Audio In Setup
Input Func.Lev.

3. Audio Input Setup

1. Digital In Assign
2. EXT. IN Setup
3. Input Function Lev.
4. Function Rename
5. IEEE1394 Assign
6. IEEE1394 Auto Func.
7. Tuner Presets
- Exit

2

(Main unit) (Remote control unit)

Display the Input Function Lev. screen.

33

*Input Func.Lev
TUNER : ◀ 0dB ▶

3-3. Input Function Lev.

Tuner	◀ 0dB ▶	DBS	: 0dB
Phono	: 0dB	VCR-1	: 0dB
CD	: 0dB	VCR-2	: 0dB
Tape	: 0dB	VCR-3	: 0dB
DVD	: 0dB	VCR-4	: 0dB
VDP	: 0dB	V.Aux	: 0dB
TV	: 0dB		

Default Yes ◀

3

① Select the input source.

(Main unit) (Remote control unit)

② Adjust the level.

The level can be adjusted between -12 dB and +12 dB in units of 1 dB.

(Main unit) (Remote control unit)

※ If "Yes" is selected for "Default", the settings are automatically reset to the default values.

4

(Main unit) (Remote control unit)

Enter the setting.
The Audio Input Setup Menu reappears.

※ After completing this setting, check that the playback levels for the different sources are the same.

3-4. Setting the Function Rename

- The names of the input sources displayed on the front display and on the on-screen display can be changed. The names or brands of the devices connected to the input sources can be input.

1

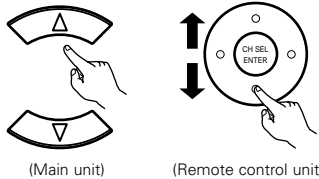

(Main unit) (Remote control unit)

Select "Function Rename" at the Audio Input Setup Menu.

3.4
 *Audio In Setup
 Function Rename

3. Audio Input Setup
 1. Digital In Assign
 2. EXT. IN Setup
 3. Input Function Lev.
 4. Function Rename
 5. IEEE1394 Assign
 6. IEEE1394 Auto Func.
 7. Tuner Presets
 Exit

2

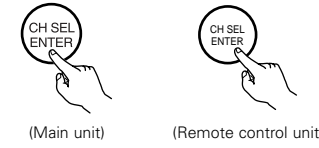

(Main unit) (Remote control unit)

Display the Function Rename screen.

3.4
 *FunctionRename
 TUNER#TUNER

3-4. Function Rename
 Tuner : TUNER
 Phono : PHONO
 CD : CD
 Tape : CDR/TAPE
 DVD : DVD
 VDP : VDP
 TV : TV

3

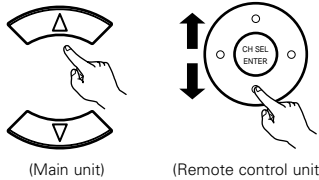

(Main unit) (Remote control unit)

Select the input source whose name you want to change.

3-4. Function Rename
 Tuner : TUNER
 Phono : PHONO
 CD : CD
 Tape : CDR/TAPE
 DVD : DVD
 VDP : VDP
 TV : TV

3-4. Function Rename
 DBS : DBS
 VCR-1 : VCR-1
 VCR-2 : VCR-2
 VCR-3 : VCR-3
 VCR-4 : VCR-4
 V.Aux : V. AUX

4

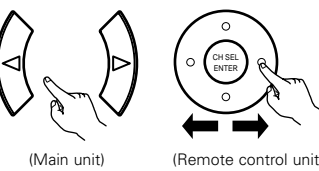

(Main unit) (Remote control unit)

Press the Cursor left and right buttons.
The screen switches to the character input screen.

3.4
 Rename TUNER
 TUNER

3-4. Function Rename
 Tuner : TUNER
 Default Yes

Example: When "TUNER" is selected and the Cursor left and right buttons are pressed

5

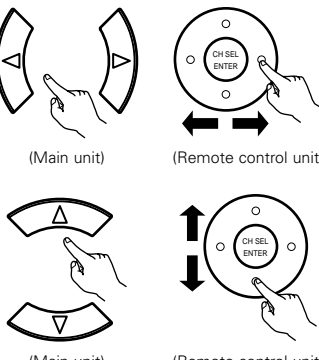

(Main unit) (Remote control unit)

- Move the cursor to choose the position at which you want to input the character using the Cursor left and right buttons.
- Select the character to be input using the Cursor up and down buttons.
Up to 8 characters can be input.

ABCDEFGHIJKLMNOPQRSTUVWXYZ
 abcdefghijklmnopqrstuvwxyz
 0123456789
 ! " # % & ' () + , - . / : ; < = > ? @ [\] (space)

6

Repeat step 5 to input the input source name.

※ If you wish to set the input source back to as it was initially, press the Cursor down button with the input source highlighted.

If "Yes" is selected for "Default", the settings are automatically reset to the default name.

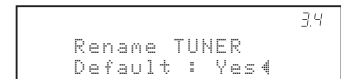
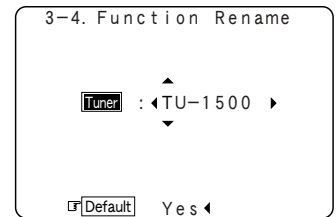
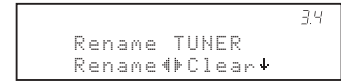
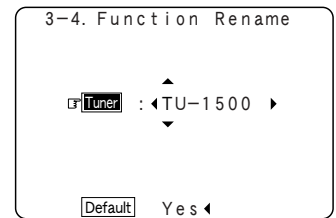
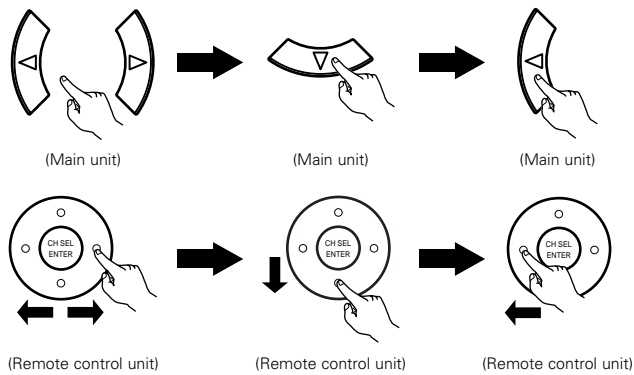

7

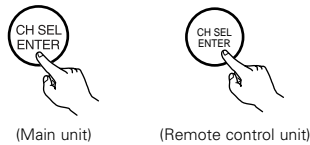

Once all the characters have been input, press the ENTER button. The Function Rename screen reappears.

※ Use the same procedure to change other input source names as well.

8

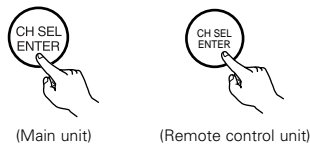

Enter the setting. The Audio Input Setup Menu reappears.

※ When the input source is selected, the display is as shown below.

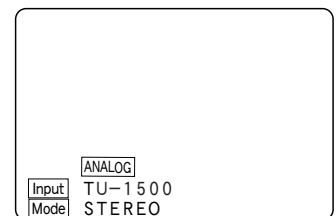
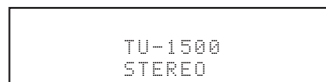

Example: When the name has been changed to "TU-1500"

3-5. Setting the IEEE1394 Assign

- Assign the device connected by IEEE1394 cable to an input source. The power of the device to be assigned must be turned on ahead of time.

1

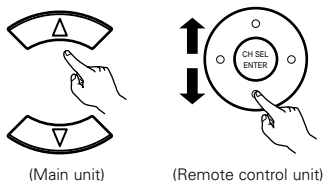

(Main unit) (Remote control unit)

Select "IEEE1394 Assign" at the Audio Input Setup Menu.

```

35
*Audio In Setup
IEEE1394 Assign
    
```

3. Audio Input Setup

1. Digital In Assign
2. EXT. IN Setup
3. Input Function Lev.
4. Function Rename
5. IEEE1394 Assign
6. IEEE1394 Auto Func.
7. Tuner Presets
- Exit

2

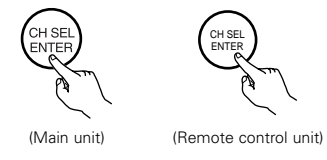

(Main unit) (Remote control unit)

Display the IEEE1394 Assign screen.

```

35
*IEEE1394Assign
DVD-39104--- ▶
    
```

3-5. IEEE1394 Assign

▶11	DVD-3910	:	◀---▶
12	DVD-5900	:	---

3

① Select the device to be assigned to the input source. ② Select the input source.

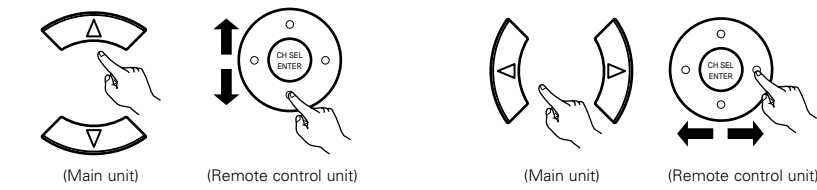

(Main unit) (Remote control unit) (Main unit) (Remote control unit)

```

35
*IEEE1394Assign
DVD-3910: DVD ▶
    
```

3-5. IEEE1394 Assign

▶11	DVD-3910	:	◀DVD▶
12	DVD-5900	:	---

4

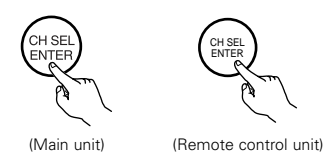

(Main unit) (Remote control unit)

Enter the setting.
The Audio Input Setup Menu reappears.

※ If you do not wish to assign the device connected by IEEE1394 cable to an input source, the IEEE1394 input can be selected by turning the FUNCTION knob. In this case, the connection information is cleared when the power of the connected device or the AVR-5805 is turned off, so the selection procedure must be performed again.

NOTES:

- By default, if no device has been connected using an IEEE1394 cable in the past, "No Connection" is displayed.
- "Connection Change" is displayed if there is a change in the IEEE1394 connection status while this screen is displayed.
- If the model name cannot be acquired from the connected IEEE1394 device, "UNKNOWN" is displayed.
- If an IEEE1394 device other than one for IEEE1394 audio playback is connected, "Not Play" is displayed and the input source cannot be assigned.

3-6. Setting the IEEE1394 Auto Function

- Set whether or not to automatically play the IEEE1394 device when it is selected with the FUNCTION knob.

1

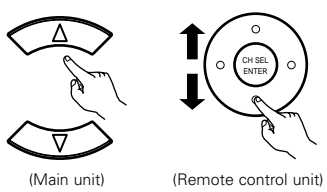

(Main unit) (Remote control unit)

Select "IEEE1394 Auto Func." at the Audio Input Setup Menu.

```

3.6
*Audio In Setup
IEEE1394 Auto
    
```

3. Audio Input Setup

1. Digital In Assign
2. EXT. IN Setup
3. Input Function Lev.
4. Function Rename
5. IEEE1394 Assign
6. IEEE1394 Auto Func.
7. Tuner Presets

Exit

2

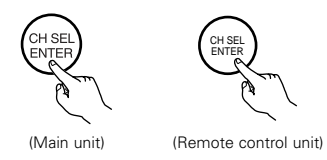

(Main unit) (Remote control unit)

Display the IEEE1394 Auto Function screen.

```

3.6
*IEEE1394 Auto
Auto Func: <OFF>
    
```

3-6. IEEE1394 Auto Func.

Auto Function <OFF>

3

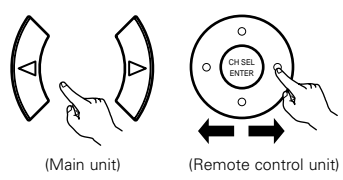

(Main unit) (Remote control unit)

Select "ON" or "OFF".

ON : Select this to automatically play the device.
OFF : Select this if you do not want to automatically play the device.

NOTE:

- In some cases settings may be required on your player. Also refer to the player's operating instructions.

4

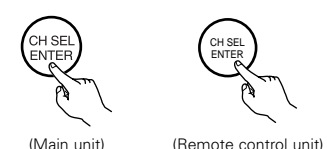

(Main unit) (Remote control unit)

Enter the setting.
The Audio Input Setup Menu reappears.

3-7. Tuner Presets

[1] Auto Preset Memory

Use this to automatically search for FM broadcasts and store up to 56 stations at preset channels A1 to 8, B1 to 8, C1 to 8, D1 to 8, E1 to 8, F1 to 8 and G1 to 8.

1

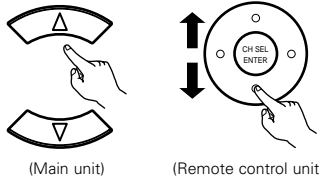

(Main unit) (Remote control unit)

Select "Tuner Presets" at the Audio Input Setup Menu.

```

3.7
*Audio In Setup
Tuner Presets
    
```

```

3. Audio Input Setup
1. Digital In Assign
2. EXT. IN Setup
3. Input Function Lev.
4. Function Rename
5. IEEE1394 Assign
6. IEEE1394 Auto Func.
7. Tuner Presets
Exit
    
```

2

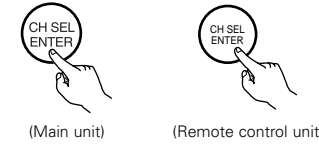

(Main unit) (Remote control unit)

Display the Tuner Presets screen.

```

3.7
*Tuner Presets
Auto Preset
    
```

```

3-7. Tuner Presets
7. Auto Preset Memory
Preset Skip
Preset Name
Exit
    
```

3

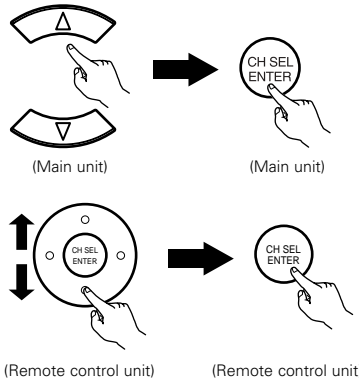

(Main unit) (Main unit)

(Remote control unit) (Remote control unit)

Select "Auto Preset Memory", then press the ENTER button.
Switch to the Auto Preset Memory screen.

```

3.7
*Auto Preset
Start :Yes#
    
```

```

3-7. Auto Preset Memory
Auto Tuning &
Preset Station Memory
Storing Preset Memory
7. Start Yes <
    
```

4

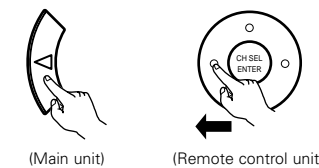

(Main unit) (Remote control unit)

Press the Cursor left button to select "Yes".
"Search" flashes on the screen and searching begins.
"Completed" appears once searching is completed.
The display automatically switches to the Tuner Presets screen.

NOTE:

- If an FM station cannot be preset automatically due to poor reception, use the "Manual tuning" operation to tune in the station, then preset it using the manual "Preset memory" operation.

[2] Preset Skip

When selecting preset channels using the Preset up and down buttons, it is possible to skip specific preset channels.

1 Select "Preset Skip" at the Tuner Presets screen.

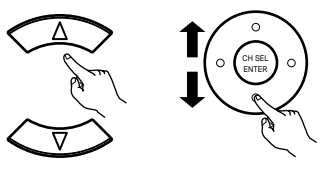

(Main unit) (Remote control unit)

3.7

*Tuner Presets
Preset Skip

3-7. Tuner Presets

Auto Preset Memory

Preset Skip

Preset Name

Exit

2 Switch to the Preset Skip screen.

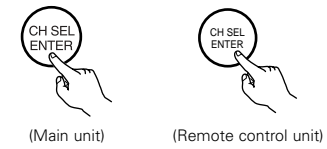

(Main unit) (Remote control unit)

3.7

*Preset Skip
A1 87.50MHz

3-7. Preset Skip

Block ◀ A ▶

<input checked="" type="checkbox"/> A1FM 87.50MHz:	<input checked="" type="checkbox"/>
A2FM 89.10MHz:	<input type="checkbox"/>
A3FM 98.10MHz:	<input type="checkbox"/>
A4FM 107.90MHz:	<input type="checkbox"/>
A5FM 90.10MHz:	<input type="checkbox"/>
A6FM 90.10MHz:	<input type="checkbox"/>
A7FM 90.10MHz:	<input type="checkbox"/>
<input checked="" type="checkbox"/> A8FM 90.10MHz:	<input type="checkbox"/>

3 ① Select the preset channel you want to skip. ② Select "ON" or "OFF".

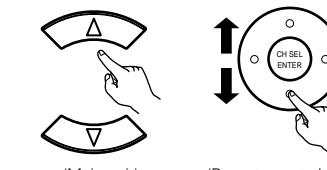

(Main unit) (Remote control unit)

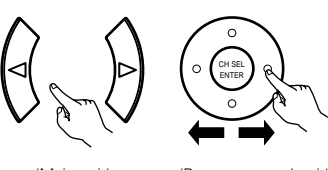

(Main unit) (Remote control unit)

3.7

*Preset Skip
A1 87.5MHz OFF

3-7. Preset Skip

Block ◀ A ▶

<input checked="" type="checkbox"/> A1FM 87.50MHz:	<input checked="" type="checkbox"/>
A2FM 89.10MHz:	<input type="checkbox"/>
A3FM 98.10MHz:	<input type="checkbox"/>
A4FM 107.90MHz:	<input type="checkbox"/>
A5FM 90.10MHz:	<input type="checkbox"/>
A6FM 90.10MHz:	<input type="checkbox"/>
A7FM 90.10MHz:	<input type="checkbox"/>
<input checked="" type="checkbox"/> A8FM 90.10MHz:	<input type="checkbox"/>

4 When the Cursor down button is pressed at the very bottom of the screen, the screen for the next preset memory block appears.

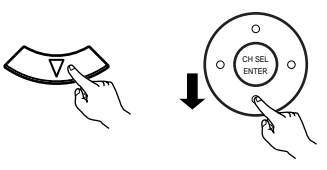

(Main unit) (Remote control unit)

※ It is also possible to select the desired preset memory block by selecting "Block" then pressing the Cursor left and right buttons.

3-7. Preset Skip

Block ◀ B ▶

B1AM 520 kHz:	<input type="checkbox"/>
B2AM 600 kHz:	<input type="checkbox"/>
B3AM 1000 kHz:	<input type="checkbox"/>
B4AM 1400 kHz:	<input type="checkbox"/>
B5AM 1500 kHz:	<input type="checkbox"/>
B6AM 1710 kHz:	<input type="checkbox"/>
B7FM 90.10MHz:	<input type="checkbox"/>
<input checked="" type="checkbox"/> B8FM 90.10MHz:	<input type="checkbox"/>

5 Repeat steps 3 and 4.

6 Press the ENTER button to return to the Tuner Presets screen.

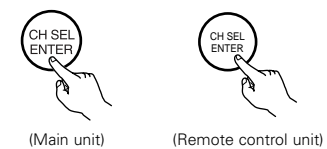

(Main unit) (Remote control unit)

[3] Preset Name

It is possible to input station names , etc., for preset channels. These names are displayed on the front display and on the on-screen display.

1 Select "Preset Name" at the Tuner Presets screen.

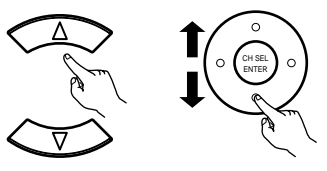

37

*Tuner Presets
Preset Name

3-7. Tuner Presets

Auto Preset Memory

Preset Skip

Preset Name

Exit

2 Switch to the Preset Name screen.

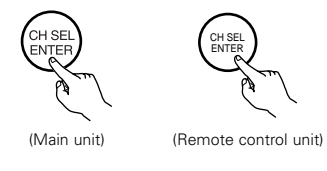

37

*Preset Name
◀A1FM 87.50MHz▶

3-7. Preset Name

Block ◀ A ▶

A1FM 87.50MHz: ◀ ▶

A2FM 89.10MHz:

A3FM 98.10MHz:

A4FM 107.90MHz:

A5FM 90.10MHz:

A6FM 90.10MHz:

A7FM 90.10MHz:

A8FM 90.10MHz:

3 Select the preset channel whose name you want to change.

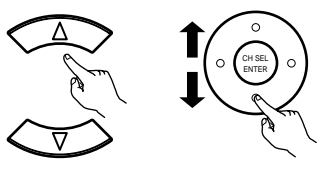

4 Press the Cursor left and right buttons. The screen switches to the character input screen.

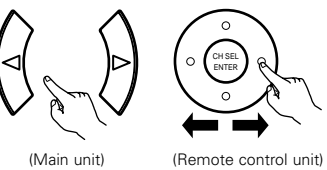

37

Name A1

3-7. Preset Name

A1FM 87.50MHz: ◀ ▶

Default Yes ◀

Example: When "A1" is selected and the Cursor left and right buttons are pressed

- 5**
- ① Move the cursor to choose the position at which you want to input the character using the Cursor left and right buttons.
 - ② Select the character to be input using the Cursor up and down buttons.
- Up to 8 characters can be input.

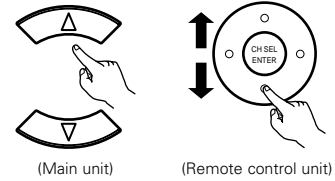
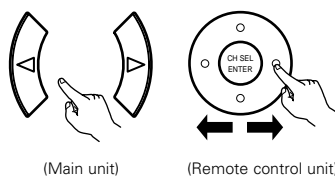

ABCDEFGHIJKLMNOPQRSTUVWXYZ

abcdefghijklmnopqrstuvwxyz

0123456789

! "# % & ' () * + , - . / : ; < = > ? @ [\] (space)

6 Repeat step 5 to input the preset channel name.

※ If you wish to set the preset channel name back to as it was initially, press the Cursor down button with the preset channel name highlighted.
If "Yes" is selected for "Default", the settings are automatically reset to the default name.

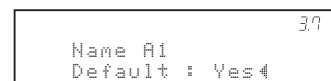
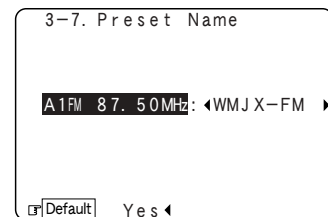
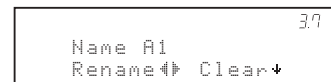
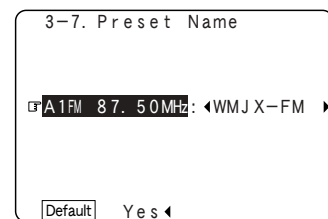
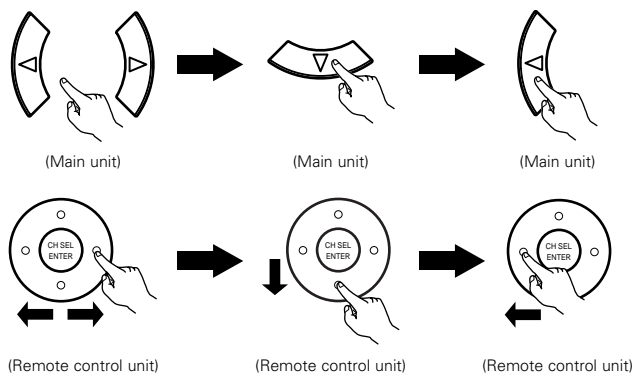

7

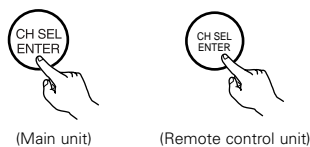

Once all the characters have been input, press the ENTER button.
The Preset Name screen reappears.

※ Use the same procedure to change other input source names as well.

8

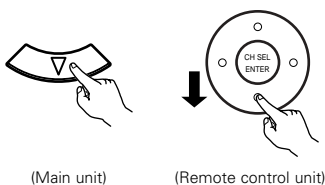

When the Cursor down button is pressed at the very bottom of the screen, the screen for the next preset memory block appears.

※ It is also possible to select the desired preset memory block by selecting "Block" then pressing the Cursor left and right buttons.

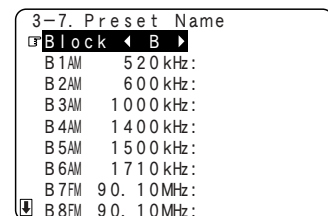

9

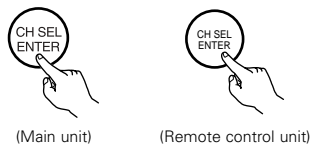

Enter the setting.
The Audio Input Setup Menu reappears.

10

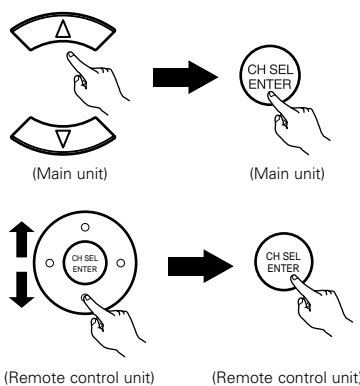

Select "Exit" and press the ENTER button at the Audio Input Setup Menu screen.
The System Setup Menu reappears.

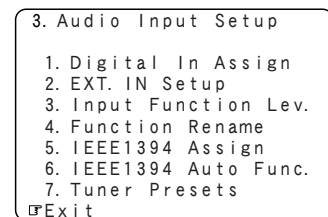
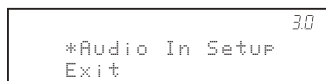

4



(Main unit)



(Remote control unit)

Enter the setting.
The Video Setup Menu reappears.

4-2. Setting the Video Convert Mode

- Select the input signal to be output to the composite S-Video and component monitor output terminals using the video conversion function.

1

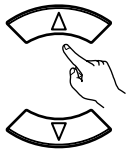

(Main unit)

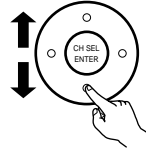

(Remote control unit)

Select "Video Convert Mode" at the Video Setup Menu.

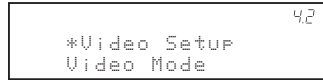

4. Video Setup

- Component In Assign
- Video Convert Mode
- Video Scaler
- 3D Y/C Separation
- HDMI/DVI In Assign
- Audio Delay
- On Screen Display
- Exit

2



(Main unit)



(Remote control unit)

Display the Video Convert Mode screen.

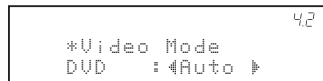

4-2. Video Convert Mode

- | | |
|-------|-----------|
| DVD | : <Auto > |
| VDP | : AUTO |
| TV | : AUTO |
| DBS | : AUTO |
| VCR-1 | : AUTO |
| VCR-2 | : AUTO |
| VCR-3 | : AUTO |
| VCR-4 | : AUTO |
| V.Aux | : AUTO |

3

① Select the input source for which you want to set the Video Convert Mode.

② Select the mode as below.

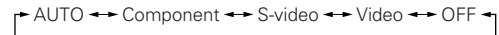

The details in each mode are as follows.

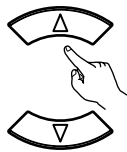

(Main unit)

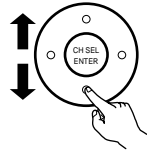

(Remote control unit)

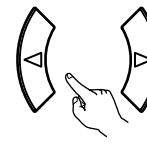

(Main unit)

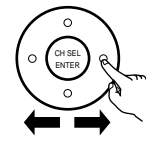

(Remote control unit)

- AUTO** : When there are multiple input signals, the input signals are detected and the input signal to be output from the video monitor output terminal is selected automatically in the following order: component video, S-Video, composite video.
- Component** : The signal connected to the component video terminal is always played.
The component input signal is down-converted and output from the composite and component monitor output terminal. No image is output from the monitor output terminal when there is no input signal to the component input terminal.
- S-Video** : The signal connected to the S-Video terminal is always played.
The S-Video input signal is converted and output from the composite and component monitor output terminal.
- Video** : The signal connected to the composite video terminal is always played.
The composite video input signal is up-converted and output from the S-Video and component monitor output terminals.
- OFF** : The convert function does not operate.
The video signal input from the video input jack is only output to the video monitor out jack.
The S-Video signal input from the S-Video input jack is only output to the S-Video monitor out jack.
The component input signal input from the component input jacks is only output to the component monitor output terminals.

NOTE:

- Down-converting from the component video signal to the S-Video and composite video signal is possible only when the resolution of a component video signal is 480i / 576i.

4



(Main unit)



(Remote control unit)

Enter the setting.
The Video Setup Menu reappears.

NOTES:

- When a non-standard video signal from a game machine or some other source is input, the video conversion function might not operate. If this happens, please set the conversion mode to OFF.
- When the video conversion function has been used, information such as that of text broadcasts which has been added to the video signal might not be output. If this happens, please set the conversion mode to OFF.

4-3. Setting the Video Scaler

- The setting of the component video output resolution and aspect ratio conversion are performed.

1



(Main unit)

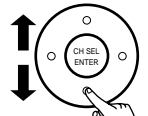

(Remote control unit)

Select "Video Scaler" at the Video Setup Menu.

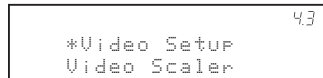

4. Video Setup

1. Component In Assign
2. Video Convert Mode
3. Video Scaler
4. 3D Y/C Separation
5. HDMI/DVI In Assign
6. Audio Delay
7. On Screen Display
- Exit

2



(Main unit)



(Remote control unit)

Display the Video Scaler screen.

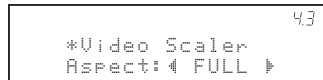

4-3. Video Scaler

Aspect ◀ FULL ▶
Resolution ◀480i/576i▶

3

① Select the Aspect.

② Please select the setting of the output video aspect ratio.

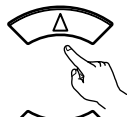

(Main unit)

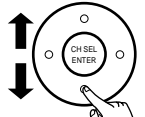

(Remote control unit)



(Main unit)

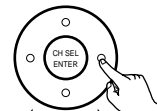

(Remote control unit)

FULL : The video is output while maintaining the aspect ratio of the input video.

This mode is suited for playing back 16:9 video.

NORMAL : A black band is added to the left and right of the input video and the video is output.

This mode is suited for playing back 4:3 video.

4

① Select the Resolution.

② Please select the resolution setting of the output video.



(Main unit)

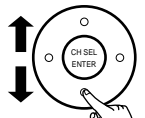

(Remote control unit)



(Main unit)

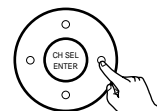

(Remote control unit)

480i / 576i : The input video is output at a resolution of 480i/576i.

480p / 576p : The input video is converted to a resolution of 480p/576p and output.

1080i : The input video is converted to a resolution of 1080i and output.

720p : The input video is converted to a resolution of 720p and output.

5



(Main unit)



(Remote control unit)

Enter the setting.
The Video Setup Menu reappears.

NOTES:

- When the component video input signal is a resolution other than 480i/576i, this setting is invalid and the input video is output without change.
- The setting of the aspect ratio is valid when the resolution has been set to 1080i or 720p. When the video is output at another resolution, please set the aspect ratio at the TV side.
- When the composite input signal or S-video input signal is in PAL format or when the component input signal is in 576i format, the video signal is output with a resolution of 576p, even if the resolution is set at 1080i or 720p.

4-4. Setting the 3D Y/C Separation

- This setting sets the action detection sensitivity of the 3-dimensional Y/C separation at the time of the video signal up-conversion to S-Video.

1

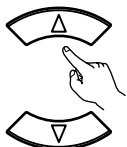

(Main unit)

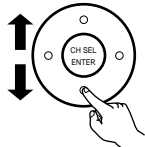

(Remote control unit)

Select "3D Y/C Separation" at the Video Setup Menu.

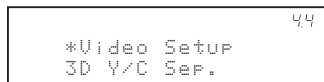

4. Video Setup

1. Component In Assign
 2. Video Convert Mode
 3. Video Scaler
 4. 3D Y/C Separation
 5. HDMI/DVI In Assign
 6. Audio Delay
 7. On Screen Display
- Exit

2



(Main unit)



(Remote control unit)

Display the 3D Y/C Separation screen.

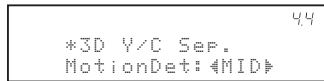

4-4. 3D Y/C Separation

Motion Detection: MID

3

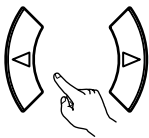

(Main unit)

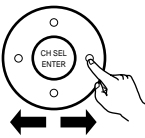

(Remote control unit)

Select the setting.

- HIGH** : This sets the action detection sensitivity to a high level. It suits video with fast action.
- MID** : This is the standard setting. Usually, this setting is recommended.
- LOW** : This sets the action detection sensitivity to a low level. It suits video with little action, such as still images, etc.

4



(Main unit)



(Remote control unit)

Enter the setting.
The Video Setup Menu reappears.

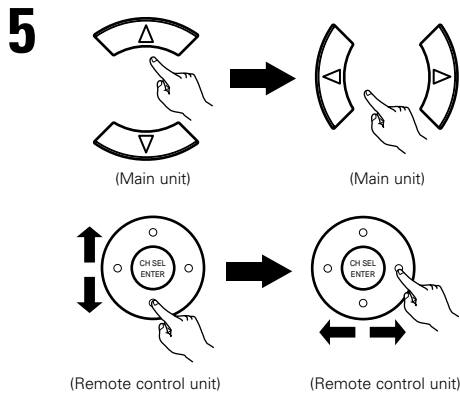

Select the method for playing the audio signals included in the HDMI input signal. Select "TV" or "AMP".

AMP : The audio signals are played according to the AVR-5805's speaker systems.

TV : The audio signals are played according to the number of playable channels on the monitor TV connected to the AVR-5805's HDMI monitor output terminal.

4-5. HDMI/DVI	In Assign
DVD :	HDMI1 [Monitor]: HDMI
VDP :	HDMI2
TV :	HDMI3 HDMI
DBS :	DVI-D [Audio]: AMP
VCR-1 :	NONE No Signal
VCR-2 :	NONE 1: EXT-1
VCR-3 :	NONE 2: EXT-2
VCR-4 :	NONE 3: ANALOG
V.Aux :	NONE

NOTE:

- If a monitor is connected with an HDMI cable but the monitor is not compatible with HDMI audio signal playback, only the video signals are output to the monitor from the AVR-5805 (DVI mode). Use the STATUS button to check which mode is set for outputting HDMI signals from the AVR-5805 (HDMI and DVI modes).

*HDMI/DVI In	45
Audio :	AMP

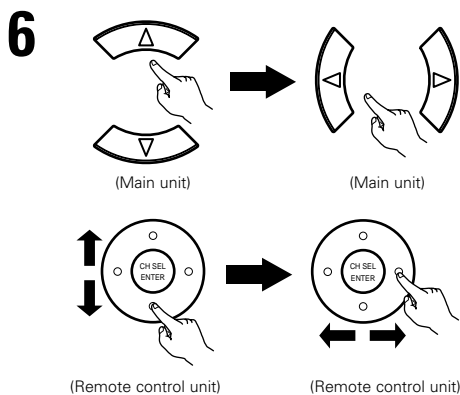

Select the input for the playback of signals when the audio signal of HDMI can not be reproduced. When the audio signal of HDMI has become unlocked, the unit automatically changes over to the set connector (ANALOG or EXT. IN). 1~3 correspond to each HDMI 1~3 input terminal. Select input signal (ANALOG or EXT. IN).

4-5. HDMI/DVI	In Assign
DVD :	HDMI1 [Monitor]: HDMI
VDP :	HDMI2
TV :	HDMI3 HDMI
DBS :	DVI-D [Audio]: AMP
VCR-1 :	NONE No Signal
VCR-2 :	NONE 1: ANALOG
VCR-3 :	NONE 2: EXT-2
VCR-4 :	NONE 3: ANALOG
V.Aux :	NONE

*HDMI/DVI In	45
1 :	ANALOG

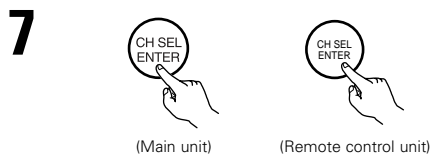

Enter the setting. The Video Setup Menu reappears.

4-6. Setting the Audio Delay

- When watching a DVD or other video source, the picture on the monitor may seem delayed with respect to the sound. In this case, adjust the audio delay to delay the sound and synchronize it with the picture.
- The audio delay setting is stored separately for each input source.

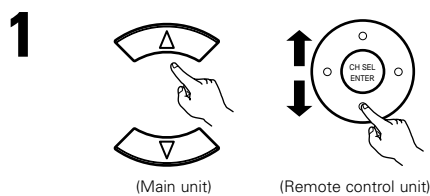

Select "Audio Delay" at the Video Setup Menu.

*Video Setup	46
Audio Delay	

4. Video Setup
1. Component In Assign
2. Video Convert Mode
3. Video Scaler
4. 3D Y/C Separation
5. HDMI/DVI In Assign
[6] 6. Audio Delay
7. On Screen Display
Exit

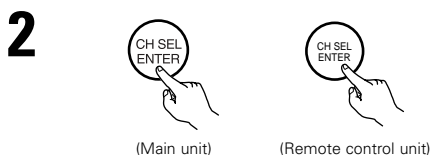

Display the Audio Delay screen.

*Audio Delay	46
0ms	

4-6. Audio Delay
Input Source : DVD
0ms

4



(Main unit)



(Remote control unit)

Enter the setting.
The Video Setup Menu reappears.

5

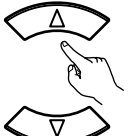

(Main unit)



(Main unit)



(Remote control unit)



(Remote control unit)

Select "Exit" and press the ENTER button at the Video Setup Menu screen.
The System Setup Menu reappears.

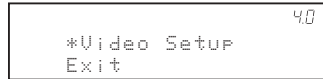

4. Video Setup

- 1. Component In Assign
- 2. Video Convert Mode
- 3. Video Scaler
- 4. 3D Y/C Separation
- 5. HDMI/DVI In Assign
- 6. Audio Delay
- 7. On Screen Display
- Exit

5

Setting the Advanced Playback

- Makes more detailed audio playback settings.

1

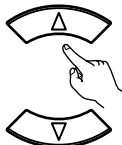

(Main unit)

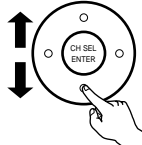

(Remote control unit)

Select "Advanced Play back" at the System Setup Menu.

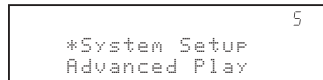

System Setup Menu

- 1. Auto Setup/Room EQ
- 2. Speaker Setup
- 3. Audio Input Setup
- 4. Video Setup
- 5. Advanced Playback
- 6. Zone Setup
- 7. Option Setup
- Exit

2



(Main unit)



(Remote control unit)

Display the Advanced Playback Menu screen.

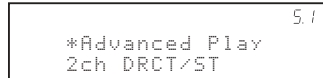

5. Advanced Playback

- 1. 2ch Direct/Stereo
- 2. Dolby Digital Setup
- 3. Auto Surround Mode
- 4. Manual EQ Setup
- Exit

5-2. Setting the Dolby Digital Setup

Sets the down-mixing method when not using a center speaker or surround speakers.

OFF: The dynamic range is not compressed.

ON: The dynamic range is compressed automatically according to the combination of speakers being used.

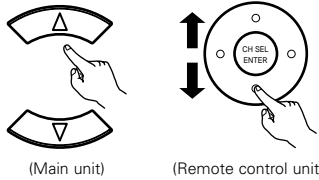
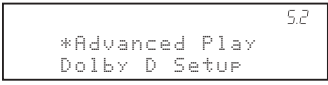

-
- 1**
- 
- (Main unit) (Remote control unit)
- Select "Dolby Digital Setup" at the Advanced Playback Menu.
- 
5. Advanced Playback

1. 2ch Direct/Stereo

2. Dolby Digital Setup

3. Auto Surround Mode

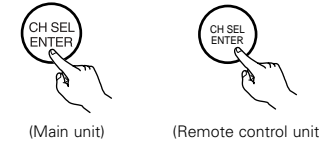
4. Manual EQ Setup

Exit
-
- 2**
- 
- (Main unit) (Remote control unit)
- Press the ENTER button.
Display the Dolby Digital Setup screen.
- 
- 5-2. Dolby Digital
Downmix Option Setup

Compression

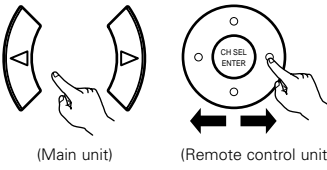
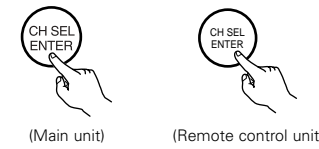
ON ← : → OFF
-
- 3**
- 
- (Main unit) (Remote control unit)
- Select "ON" if you want to use the Compression, "OFF" if you do not want to use it.
- ※ Set "Compression" to "ON" if it seems that sound is distorted because the input level exceeds the allowable input for the front speakers.
- NOTE:**
When a center speaker or surround speakers are not connected, the sounds in those channels are directed to the front speakers.
-
- 4**
- 
- (Main unit) (Remote control unit)
- Enter the setting.
The Advanced Playback Menu reappears.
-

5-3. Setting the Auto Surround Mode

The surround mode used at last for the four types of input signals shown below is stored in the memory, and the signal is automatically played with that surround mode the next time it is input.

Note that the surround mode setting is also stored separately for the different input sources.

- ① Analog and PCM 2-channel signals (STEREO)
- ② 2-channel signals of Dolby Digital, DTS or other multi-channel format (DOLBY PLIIx cinema)
- ③ Multi-channel signals of Dolby Digital, DTS or other multi-channel format (DOLBY/DTS SURROUND)
- ④ PCM and DSD multi-channel signals other than Dolby Digital and DTS (MULTI CH IN)

※ Default settings are indicated in ().

※ During playback in the PURE DIRECT mode, the surround mode does not change even if the input signal is changed.

1



(Main unit)

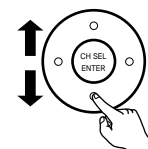

(Remote control unit)

Select "Auto Surround Mode" at the Advanced Playback Menu.

5.3

*Advanced Play
Auto Surround

5. Advanced Playback

1. 2ch Direct/Stereo
2. Dolby Digital Setup
3. Auto Surround Mode
4. Manual EQ Setup

Exit

2



(Main unit)



(Remote control unit)

Press the ENTER button.
Display the Auto Surround Mode screen.

5.3

*Auto Surround
ON/OFF: ON ▶

5-3. Auto Surround Mode

ON ◀ : ▶ OFF

3

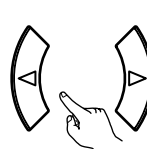

(Main unit)

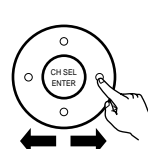

(Remote control unit)

Select "ON" if you want to use the auto surround mode, "OFF" if you do not want to use it.

4



(Main unit)



(Remote control unit)

Enter the setting.
The Advanced Playback Menu reappears.



※ Contents stored in the auto surround mode can be checked with the on-screen display.

Auto Surround Mode [CD]

[ANALOG] [PCM]

2ch : STEREO

[Multi] [ch] : MULTI CH IN

[DIGITAL]

2ch : DOLBY PLIIx cinema

5. 1ch : DOLBY/DTS SURROUND

OSD-4

5-4. Setting the Manual EQ Setup

- Allows you to adjust the tonal quality of the various speakers (except the subwoofer) while listening to a music source.

1

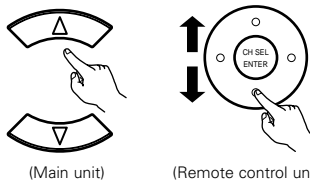

(Main unit) (Remote control unit)

Select "Manual EQ Setup" at the Advanced Playback Menu.

5.4

*Advanced Play
Manual EQ Setup

5. Advanced Playback

1. 2ch Direct/Stereo
2. Dolby Digital Setup
3. Auto Surround Mode
4. Manual EQ Setup

Exit

2

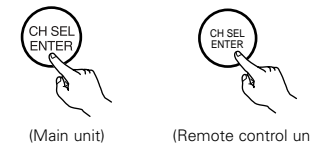

(Main unit) (Remote control unit)

Display the Manual EQ screen.

5.4

*Manual EQ
Adjust CH ◀L/R ▶

5-4. Manual EQ

Default Yes ◀
Base Curve Copy ◀

4. Adjust CH ◀L/R CH ▶

Exit

3

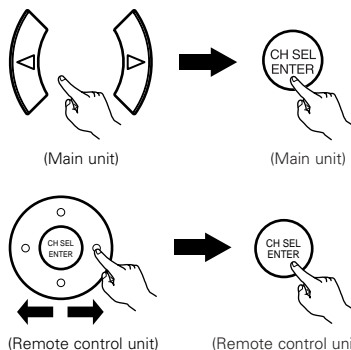

(Main unit) (Main unit)

(Remote control unit) (Remote control unit)

Select the adjustment mode, then press the ENTER button.

All CH : All channels can be adjusted simultaneously.
L/R CH : The left and right channels of the pair of speakers can be adjusted simultaneously.
Each CH : The channels can be adjusted separately.

4

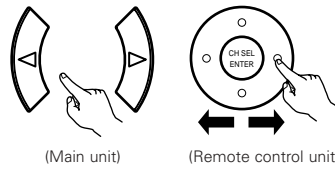

(Main unit) (Remote control unit)

Select the speaker to be set.
The display changes as follows.

① Select "L/R CH"

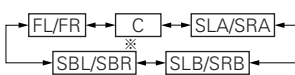

② Select "Each CH"

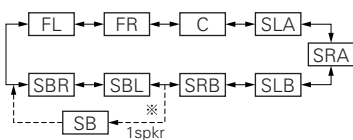

Manual EQ ◀Front L/R ▶

63Hz	0.0dB
125Hz	0.0dB
250Hz	0.0dB
500Hz	0.0dB
1kHz	0.0dB
2kHz	0.0dB
4kHz	0.0dB
8kHz	0.0dB
16kHz	0.0dB

5.4

*Manual EQ: L/R
◀ Front L/R ▶

Example: When "L/R CH" is selected.

※ When the surround back speaker setting is set to "1spkr" at "Speaker Configuration", this is set to "SB".

③ Select "All CH"

In this case, speaker selection is not performed.

※ If a value is already set for the FL channel, the data stored for the FL channel is displayed.

5

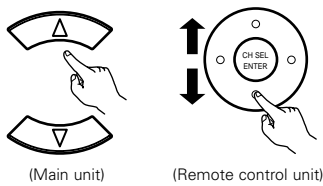

Select the frequency.

```

5.4
*Manual EQ:L/R
63Hz : 0.0dB
    
```

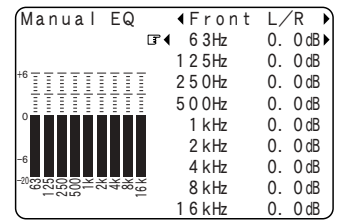

6

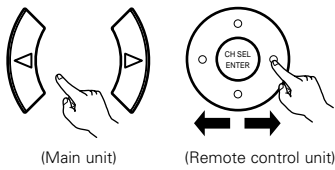

Use the Cursor left and right buttons to adjust the Gain level.

- Each frequency can be adjusted the range from -20 dB to +6 dB in 0.5 dB step.

7

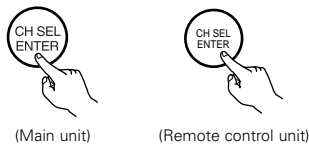

Enter the setting.

The Manual EQ screen reappears.

8

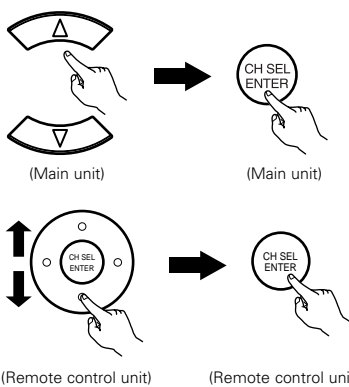

Select "Exit", then press the ENTER button.
The Advanced Playback Menu reappears.

```

5.4
*Manual EQ
Exit
    
```

```

5-4. Manual EQ
Default Yes ◀
Adjust CH ◀L/R CH ▶
Exit
    
```

9

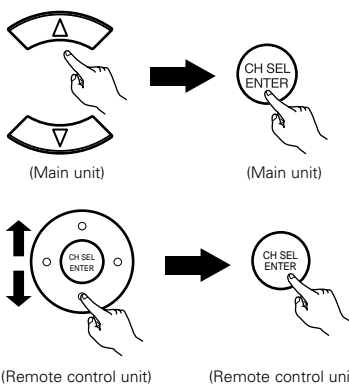

Select "Exit" and press the ENTER button at the
Advanced Playback Menu screen.
The System Setup Menu reappears.

```

5.0
*Advanced Play
Exit
    
```

```

5. Advanced Playback
1. 2ch Direct/Stereo
2. Dolby Digital Setup
3. Auto Surround Mode
4. Manual EQ Setup
Exit
    
```





※ To restore the settings to their defaults, select "Default Yes ◀" then press the Cursor left button.

```

5-4. Manual EQ
Default Yes ◀
Base Curve Copy ◀
Adjust CH ◀L/R CH ▶
Exit
    
```

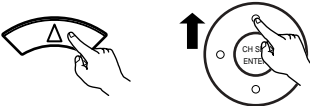
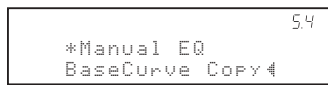
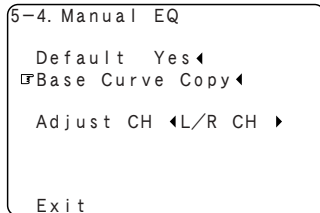
■ Procedure for copying the “Flat” correction curve set at “Auto Setup”, then using the graphic equalizer to adjust manually

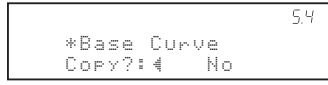
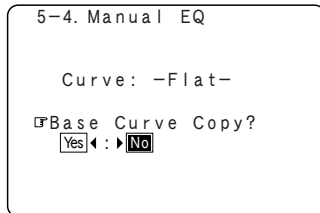
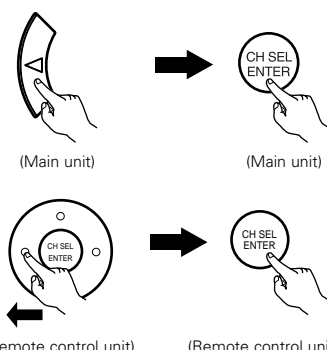
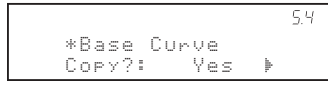
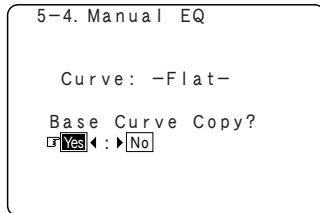
NOTE: If the “Auto Setup” procedure has not been performed, this item is not displayed.

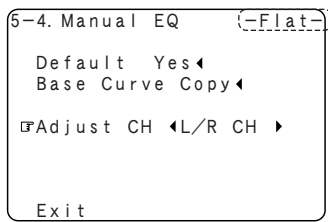
<p>1</p>  <p>(Main unit) (Remote control unit)</p>	<p>Select “Base Curve Copy”.</p> 	
<p>2</p>  <p>(Main unit) (Remote control unit)</p>	<p>The Base Curve Select screen appears when the Cursor left button is pressed.</p> 	
<p>3</p>  <p>(Main unit) (Main unit) (Remote control unit) (Remote control unit)</p>	<p>Select “Base Curve Copy?”, then press the Cursor left button to select “Yes”.</p> 	
<p>4</p>  <p>(Main unit) (Remote control unit)</p>	<p>Enter the setting. The Manual EQ screen reappears. The type of the copied correction curve is displayed in the upper right of this screen.</p>	

6

Setting the Zone Setup (Zone2 = 5.1/7.1ch)

- Make the settings related to surround playback and video for Zone2.
- Adjust the sound played in Zone3 and Zone4.

1

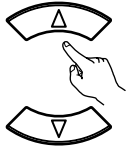

(Main unit)

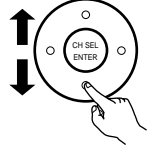

(Remote control unit)

Select "Zone Setup" at the System Setup Menu.

```
*System Setup      6
Zone Setup
```

System Setup Menu

1. Auto Setup/Room EQ
2. Speaker Setup
3. Audio Input Setup
4. Video Setup
5. Advanced Playback
6. Zone Setup
7. Option Setup
- Exit

2



(Main unit)



(Remote control unit)

Display the Zone Setup Menu screen.

```
*Zone Setup      6.1
Z2 Sp Config.
```

6. Zone Setup

1. Speaker Config.
2. Subwoofer Mode
3. Delay Time
4. Channel Level
5. Crossover Frequency
6. Video Setup
7. Zone3/4 Tone/Ch Lev.
- Exit

NOTE:

- When "STEREO" or "MONO" is selected for the Zone2 channel output setting at "7-1. Channel Setup" (see pages 97~100), the menu screen displayed differs. In this case, see the instructions starting at page 96.

6-1. Setting the type of speakers for Zone2

- The composition of the signals output to each channels and the frequency response are adjusted automatically according to the combination of speakers actually being used in Zone2.

1

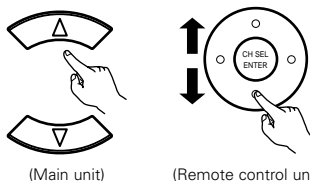

(Main unit) (Remote control unit)

Select "Speaker Config." at the Zone Setup Menu.

```
*Zone Setup      6.1
Z2 Sp Config.
```

6. Zone Setup

- 1. Speaker Config.
- 2. Subwoofer Mode
- 3. Delay Time
- 4. Channel Level
- 5. Crossover Frequency
- 6. Video Setup
- 7. Zone3/4 Tone/Ch Lev.
- Exit

2

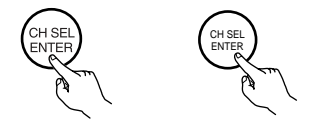

(Main unit) (Remote control unit)

Display the Speaker Config. screen as below.

3

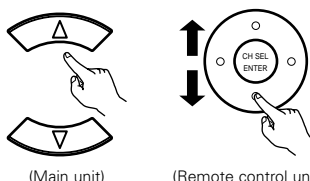

(Main unit) (Remote control unit)

Set whether speakers are connected or not in Zone2 and their size parameters. Select the speakers connected in Zone2 and the size parameters.

① Select the speaker.

6-1. Speaker Config. Zone-2

Front Sp. Large Small

Center Sp. Small None

Subwoofer Yes No

6-1. Speaker Config. Zone-2

Surround Sp. Small None

```
*Z2 Sp Config.      6.1
Front : 4Small
```

② Select the parameter.

* For a description of the different parameters, see page 47.

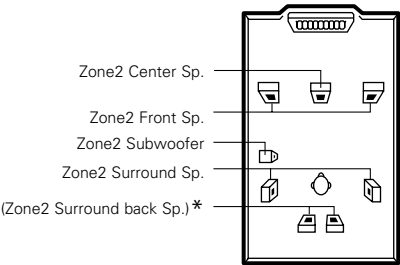

4



(Main unit) (Remote control unit)

Enter the setting. The Zone Setup Menu reappears.

* This is only displayed when "7.1ch" is selected for the Zone2 channel output setting at "7-1. Channel Setup". (See pages 97~100)

6-2. Setting the low frequency distribution for Zone2

- Set the subwoofer mode according to the speaker systems used in Zone2.

1

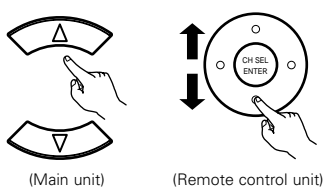

(Main unit) (Remote control unit)

Select "Subwoofer Mode" at the Zone Setup Menu.

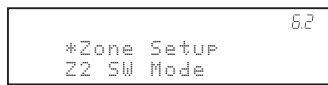

```
*Zone Setup      6.2
Z2 SW Mode
```

6. Zone Setup

1. Speaker Config.
2. Subwoofer Mode
3. Delay Time
4. Channel Level
5. Crossover Frequency
6. Video Setup
7. Zone3/4 Tone/Ch Lev.
- Exit

2

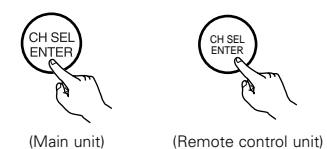

(Main unit) (Remote control unit)

Display the Subwoofer Mode screen.

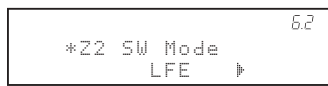

```
*Z2 SW Mode      6.2
LFE
```

6-2. Subwoofer Mode Zone-2

LFE ◀▶ LFE
+Main

3

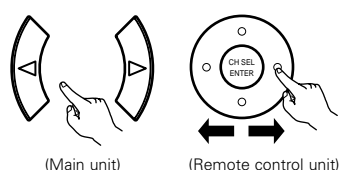

(Main unit) (Remote control unit)

Select the setting.

LFE :
For any channel(s) that are set to LARGE, low frequencies in that channel's corresponding source are directed to that loudspeaker only. Low frequencies that are directed to the subwoofer(s) are from the program source LFE channel, and from other channels where the speakers are set to SMALL.

LFE + Main :
Low frequencies from speaker channels that have been set to LARGE are reproduced from those speakers as well as from the subwoofer(s). Depending upon the characteristics of the LARGE main speakers, this mode may provide a more even low frequency response throughout the listening room.

4

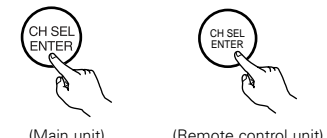

(Main unit) (Remote control unit)

Enter the setting.
The Zone Setup Menu reappears.

NOTE:

- The subwoofer mode setting is only valid when "Large" is set for the Zone2 front speakers and "Yes" is set for the subwoofer in the "6-1. Speaker Configuration" settings. (See page 86)

6-3. Setting the Delay Time for Zone2

- Input the distance between the listening position and each speakers in Zone2 to set the surround delay time for Zone2.

1

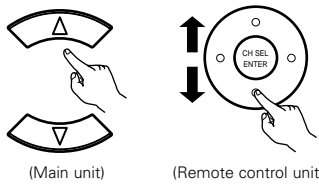

(Main unit) (Remote control unit)

Select "Delay Time" at the Zone Setup Menu.



6. Zone Setup

1. Speaker Config.
2. Subwoofer Mode
3. Delay Time
4. Channel Level
5. Crossover Frequency
6. Video Setup
7. Zone3/4 Tone/Ch Lev.
- Exit

2

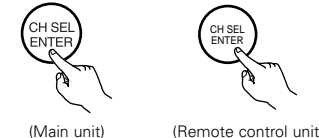

(Main unit) (Remote control unit)

Display the Delay Time screen.

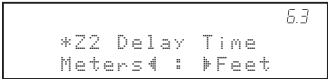

6-3. Delay Time Zone-2

Set The Distance To Each Speakers

Do You Prefer In Meters? / In Feet?

Meters < > Feet

3

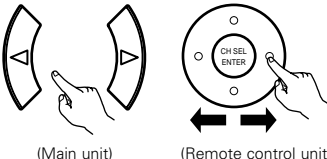

(Main unit) (Remote control unit)

Select the desired unit, meters or feet.

6-3. Delay Time Zone-2

Set The Distance To Each Speakers

Do You Prefer In Meters? / In Feet?

Meters < > **Feet**

Example: When "Feet" is selected

4 Once "Meters" or "Feet" is selected in step 3, the Delay Time screen appears automatically.



6-3. Delay Time Zone-2

Step < 1ft >

Default Yes <

FL < 12.0ft >

FR 12.0ft

C 12.0ft

SW 12.0ft

6-3. Delay Time Zone-2

SL < 10.0ft >

SR 10.0ft

5

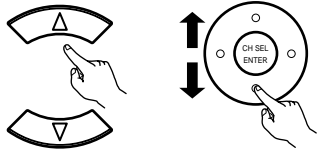

(Main unit) (Remote control unit)

Select the speaker to be set.
The picture of the speaker selected blinks.

6

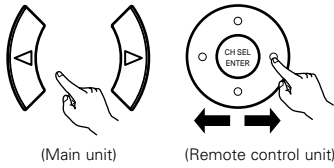

Set the distance between the center speaker and listening position.
 The distance changes in units of 0.1 foot (0.03 meters) or 1 foot (0.3 meters) each time the button is pressed. Select the value closest to the measured distance.

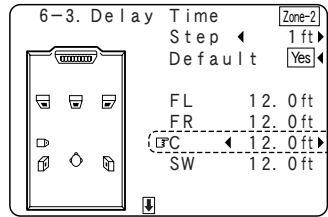

Example: When the distance is set to 12 feet for the center speaker

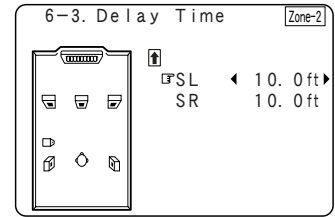

- ※ If "Yes" is selected for "Default", the settings are automatically reset to the default values.
- ※ When "Step" is selected, you can select the unit of "1ft (0.1m)" or "0.1ft (0.01m)".

Please note that the difference of distance for every speaker should be 20 ft (6.0 m) or less. If you set an invalid distance, a CAUTION notice, such as screen right will appear. In this case, please relocate the blinking speaker(s) so that its distance is no larger than the value shown in highlighted line.

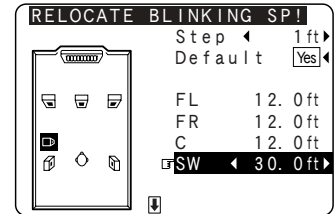

7

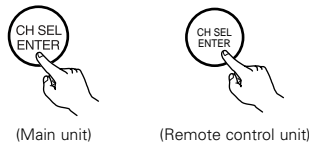

Enter the setting.
 The Zone Setup Menu reappears.
 The AVR-5805 automatically sets the optimum surround delay time for the Zone2 listening room.

6-4. Setting the Channel Level for Zone2

- Use this setting to adjust so that the playback level between the different channels of Zone2 is equal.
- From the Zone2 listening position, listen to the test tones produced from the speakers used in Zone2 to adjust the level.
- The level can also be adjusted directly from the Remote control unit. (For details, see pages 159, 160.)

1

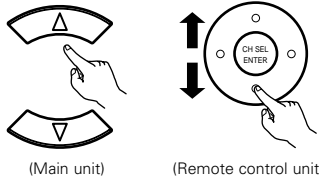

(Main unit) (Remote control unit)

Select "Channel Level" at the Zone Setup Menu.

6.4

*Zone Setup
Z2 Channel Lev.

6. Zone Setup

1. Speaker Config.
2. Subwoofer Mode
3. Delay Time
4. Channel Level
5. Crossover Frequency
6. Video Setup
7. Zone3/4 Tone/Ch Lev.

Exit

2

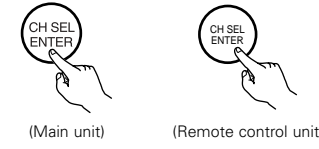

(Main unit) (Remote control unit)

Display the Channel Level screen.

6.4

*Z2 Channel Lev
T.Tone: Auto ▶

6-4. Channel Level Zone-2

Test Tone Auto ◀ : ▶ Manual

Test Tone Start Yes ◀

Level Clear Yes ◀

3

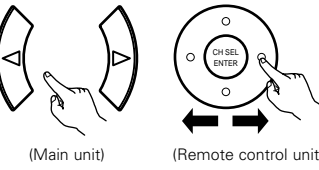

(Main unit) (Remote control unit)

Select the mode.
Select "Auto" or "Manual".

6.4

*Z2 Channel Lev
T.Tone: Auto ▶

6-4. Channel Level Zone-2

Test Tone Auto ◀ : ▶ Manual

Test Tone Start Yes ◀

Level Clear Yes ◀

Auto :
Adjust the level while listening to the test tones produced automatically from each speaker.

Manual :
Select the speaker from which you want to produce the test tone to adjust the level.

Example: When the "Auto" mode is selected

4

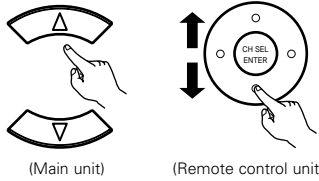

(Main unit) (Remote control unit)

Select "Test Tone Start".

6.4

*Z2 Channel Lev
Tone Start: Yes ◀

6-4. Channel Level Zone-2

Test Tone Auto ◀ : ▶ Manual

Test Tone Start Yes ◀

Level Clear Yes ◀

5

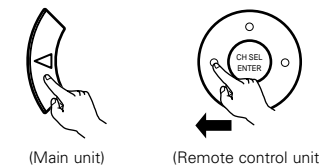

(Main unit) (Remote control unit)

Select "Yes".

6-4. Channel Level Zone-2

Test Tone Auto ◀ : ▶ Manual

Test Tone Start Yes ◀

Level Clear Yes ◀

90

6

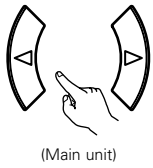

(Main unit)

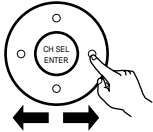

(Remote control unit)

- a. When "Auto" mode is selected:
 Test tones are automatically emitted from each speaker used in Zone2.
 The test tones are emitted from each speaker in the following order, at 4-second intervals the first time and second time around, 2-second intervals the third time around and on:

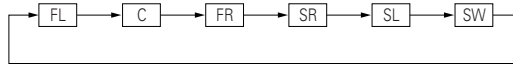

Use the Cursor left and right buttons to adjust all the speakers to the same volume.
 The volume can be adjusted between -12 dB and +12 dB in units of 0.5 dB.

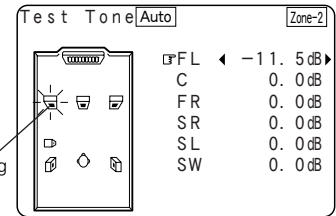

Example: When the volume is set to -11.5 dB while the test tone is being produced from the Front Lch speaker

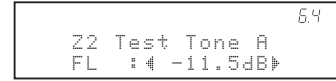

- b. When "Manual" mode is selected:

① Select the speaker used in Zone2.

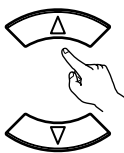

(Main unit)

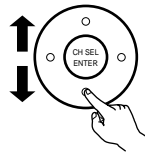

(Remote control unit)

② Adjust all the speakers to the same volume.

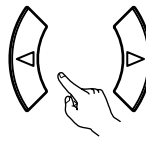

(Main unit)

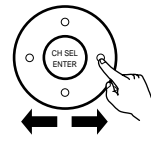

(Remote control unit)

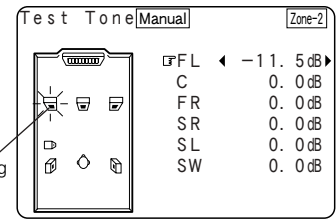

Example: "Manual" mode is selected.

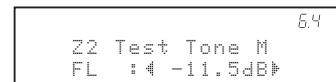

7



(Main unit)



(Remote control unit)

Enter the setting.
 The Channel Level screen reappears.

※ To cancel the settings, press the Cursor down button to select "Level Clear" and "Yes" on the "Channel Level" screen, then make the settings again.

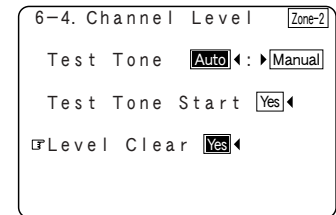

NOTES:

- When adjusting the level of an active subwoofer system, you may also need to adjust the subwoofer's own volume control.
- When you adjust the channel levels while in the SYSTEM SETUP CHANNEL LEVEL mode, the channel level adjustments made will affect all surround modes for Zone2.
- After you have completed the SYSTEM SETUP CHANNEL LEVEL adjustments, you can then activate the individual surround modes and adjust channel levels that will be remembered for each of those modes. Then, whenever you activate a particular surround sound mode, your preferred channel level adjustments for just that mode will be recalled. Check the instructions for adjusting channel levels within each surround mode. (See pages 159, 160)
- You can adjust the channel levels for each of the following surround modes for Zone2: STEREO, DOLBY/DTS SURROUND, 5/7 CH STEREO, WIDE SCREEN, SUPER STADIUM, ROCK ARENA, JAZZ CLUB, CLASSIC CONCERT, MONO MOVIE, VIDEO GAME, MATRIX and VIRTUAL.

6-5. Setting the Crossover Frequency for Zone2

- Set the frequency (in Hz) below which deep bass appearing in the main channels will be routed to the Zone2 subwoofer.

1

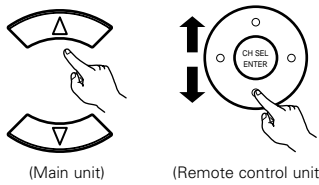

(Main unit) (Remote control unit)

Select the "Crossover Frequency" at the Zone Setup Menu.



6. Zone Setup

1. Speaker Config.
2. Subwoofer Mode
3. Delay Time
4. Channel Level
5. Crossover Frequency
6. Video Setup
7. Zone3/4 Tone/Ch Lev.

Exit

2

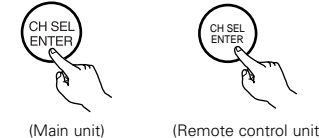

(Main unit) (Remote control unit)

Display the Crossover Frequency screen.

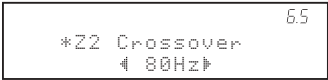

6-5. Crossover Frequency Zone-2

◀ Variable ▶
80Hz

3

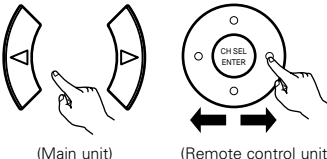

(Main unit) (Remote control unit)

Select the frequency.

VARIABLE 40, 60, 80, 100, 120, 150, 200, 250 Hz :
Set as desired according to your speakers' bass playback ability.

4

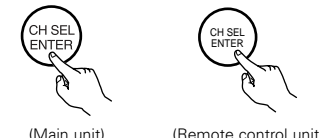

(Main unit) (Remote control unit)

Enter the setting.
The Zone Setup Menu reappears.

NOTES:

- For the majority of home theater speaker systems, we recommend that the crossover frequency be set to 80 Hz. When using very compact speakers, however, it may be advantageous to select a higher crossover frequency. Check the specified low frequency limit of each speaker (usually published in the specifications tables in speaker owner's manuals).
- The crossover frequency mode is valid only when subwoofer is set to ON, and when one or more speakers are set to SMALL, as described in section "6-1. Speaker Configuration" settings. (See page 86)

5



(Main unit)



(Remote control unit)

Press the ENTER button to return to the Video Setup screen.

[2] Audio Delay (Zone2)

- Set this if it seems there is a delay in the picture on the monitor screen with respect to the sound when watching a DVD or other video source in the Zone2 listening room. Adjust the audio delay to delay the sound and synchronize the sound and picture.
- The audio delay setting is stored in the memory individually for the different input sources selected at Zone2.

1

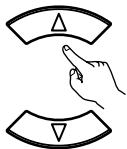

(Main unit)

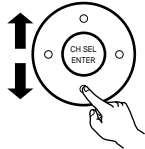

(Remote control unit)

Select "Audio Delay" at the Video Setup screen.

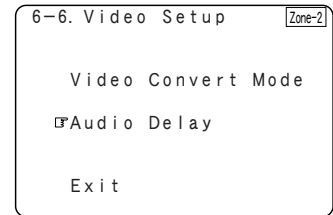
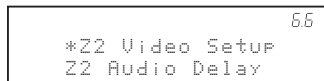

2



(Main unit)



(Remote control unit)

Display the Audio Delay screen.

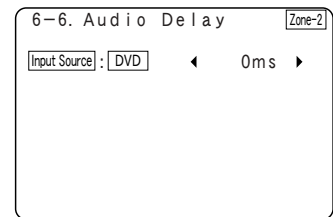

3

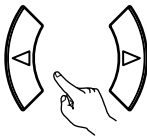

(Main unit)

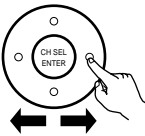

(Remote control unit)

Set the delay time. (0 ms ~ 200 ms)

With a movie source, for example, adjust so that the movement of the actors' lips is synchronized with the sound.

4



(Main unit)



(Remote control unit)

Press the ENTER button to return to the Video Setup screen.

5

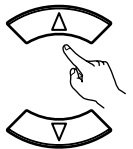

(Main unit)



(Main unit)

Select "Exit", then press the ENTER button to return the Zone Setup Menu screen.

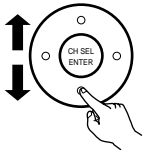
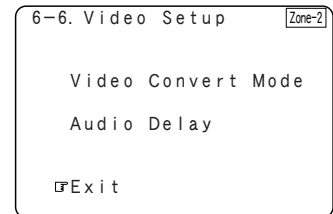
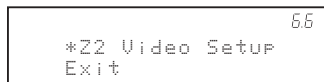

(Remote control unit)



(Remote control unit)

6

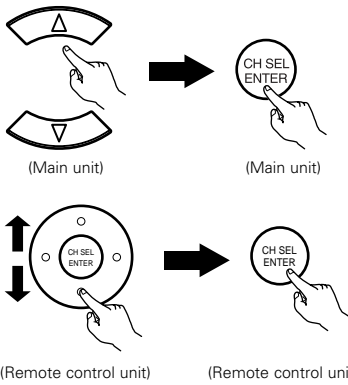

Select "Exit" then press the ENTER button.
The Zone Setup Menu reappears.

```
*Zone3/4      6.7
Exit
```

```
6-7. Zone3/4 Tone/Ch Lev.

Zone3 Tone/Ch Lev.
Zone4 Tone/Ch Lev.

Exit
```

7

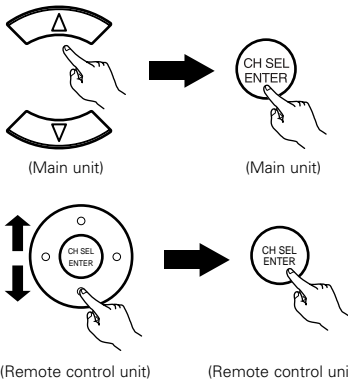

Select "Exit" and press the ENTER button at Zone
Setup Menu screen.
The System Setup Menu reappears.

```
*Zone Setup   6.0
Exit
```

```
6. Zone Setup

1. Speaker Config.
2. Subwoofer Mode
3. Delay Time
4. Channel Level
5. Crossover Frequency
6. Video Setup
7. Zone3/4 Tone/Ch Lev.

Exit
```

■ "Zone Setup" setting when Zone2 is set to "STEREO" or "MONO"

The "Zone Setup" screen shown below is displayed when "STEREO" or "MONO" is selected for the Zone2 channel setting at "7-1. Channel Setup".

```
*Zone Setup   6.1
Z2 Tone/Ch Lev.
```

```
6. Zone Setup

Exit
1. Zone2 Tone/Ch Lev.
2. Zone3 Tone/Ch Lev.
3. Zone4 Tone/Ch Lev.
4. Video Setup
```

- For instructions on making the Zone2, 3 and 4 "Tone/Ch Level" settings (items 1 to 3), see pages 95, 96.
- For instructions on the "Video Setup" (item 4), see pages 93, 94.

7

Setting the Option Setup

- Make other expert settings.

1

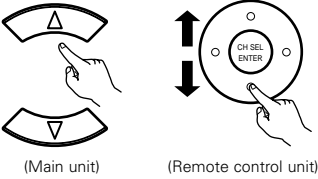

(Main unit) (Remote control unit)

Select "Option Setup" at the System Setup Menu.

```
*System Setup
Option Setup
```

System Setup Menu

1. Auto Setup/Room EQ
2. Speaker Setup
3. Audio Input Setup
4. Video Setup
5. Advanced Playback
6. Zone Setup
7. Option Setup
- Exit

2

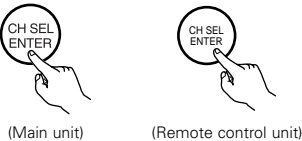

(Main unit) (Remote control unit)

Display the Option Setup Menu Screen.

```
*Option Setup
Channel Setup
```

7. Option Setup

1. Channel Setup
2. Power Amp Assign
3. Volume Control
4. Trigger Out
5. AC Outlet Assign
6. Setup Memory/Lock
- Exit

7-1. Setting the Channel setup

- With this setting it is possible to change the number of channels played in the different zones according to the purpose. The AVR-5805 is equipped with pre-out connectors for a total of 22 channels. 16 channel of these pre-out connectors can be assigned between the Main zone and Zone2 (Theater). In addition, up to three channels of subwoofers can be added to the Main zone, so subwoofers can be set in the front and back or at the sides. The number of channels output from the pre-out connectors exclusively for Zone2, 3 and 4 can be set to "MONO" or "STEREO" according to the method of playback in the various multi-zones.

■ Channel setup flow

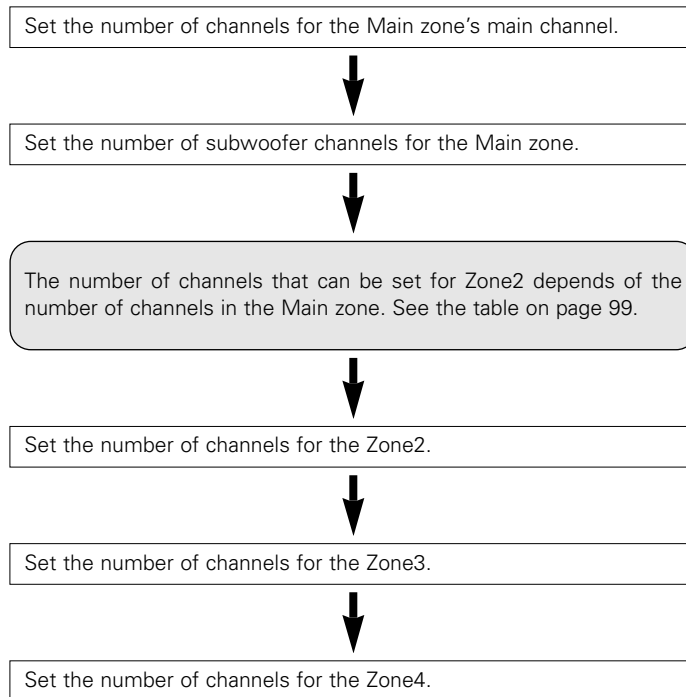

1

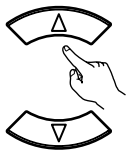

(Main unit)

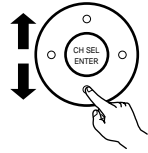

(Remote control unit)

Select "Channel Setup" at the Option Setup Menu.

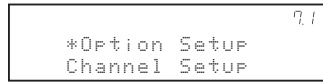

7. Option Setup	
<input checked="" type="checkbox"/>	1. Channel Setup
<input type="checkbox"/>	2. Power Amp Assign
<input type="checkbox"/>	3. Volume Control
<input type="checkbox"/>	4. Trigger Out
<input type="checkbox"/>	5. AC Outlet Assign
<input type="checkbox"/>	6. Setup Memory/Lock
Exit	

2



(Main unit)



(Remote control unit)

Display the Channel Setup screen.



7-1. Channel Setup	
Main Zone	
<input checked="" type="checkbox"/>	Main ◀ 9.1CH ▶
	Subwoofer ◀ 1SP ▶
	Zone2 ◀ 5.1CH ▶
	Zone3 ◀ Stereo ▶
	Zone4 ◀ Stereo ▶

3

① Select the Zone.

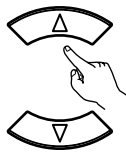

(Main unit)

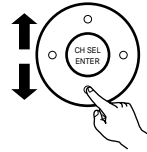

(Remote control unit)

② Select the channel setting.

Also select the number of subwoofers and the output composition to be used in the Main zone.
Refer to the table on page 99.

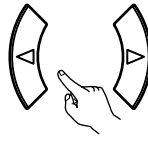

(Main unit)

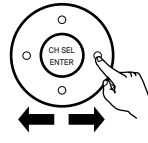

(Remote control unit)

7-1. Channel Setup	
Main Zone	
<input checked="" type="checkbox"/>	Main ◀ 9.1CH ▶
	Subwoofer ◀ 3SP [L/R/LFE] ▶
	Zone2 ◀ Stereo ▶
	Zone3 ◀ Stereo ▶
	Zone4 ◀ Stereo ▶

4



(Main unit)



(Remote control unit)

Enter the setting.
The Option Setup Menu reappears.

■ The number of channels that can be selected for the different zones is as shown below.

MAIN ZONE		ZONE2	ZONE3	ZONE4
Main	Subwoofer			
9.1 CH	1 SP	5.1 CH / STEREO / MONO	STEREO / MONO	STEREO / MONO
	2 SP	STEREO / MONO	STEREO / MONO	STEREO / MONO
	3 SP	STEREO / MONO	STEREO / MONO	STEREO / MONO
7.1 CH	1 SP	7.1 CH / 5.1 CH / STEREO / MONO	STEREO / MONO	STEREO / MONO
	2 SP	5.1 CH / STEREO / MONO	STEREO / MONO	STEREO / MONO
	3 SP	5.1 CH / STEREO / MONO	STEREO / MONO	STEREO / MONO
5.1 CH	1 SP	7.1 CH / 5.1 CH / STEREO / MONO	STEREO / MONO	STEREO / MONO
	2 SP	7.1 CH / 5.1 CH / STEREO / MONO	STEREO / MONO	STEREO / MONO
	3 SP	7.1 CH / 5.1 CH / STEREO / MONO	STEREO / MONO	STEREO / MONO

NOTE:

- The channel settings that can be selected for Zone2 depend on the channel settings for the main zone.

■ The subwoofer output composition is as shown below.

Subwoofer	Output Composition	
1 SP	–	Select this when only one subwoofer is connected.
2 SP	L/R	Select this when subwoofers are installed on the left and right.
	F/B	Select this when subwoofers are installed at the front and rear.
	LFE/M	Select this to use the subwoofer for both the main channel's low frequencies and for LFE low frequencies.
3 SP	L/R/LFE	Select this when subwoofers are installed on the left and right and you are using a subwoofer specifically for the LFE.
	F/B/LFE	Select this when subwoofers are installed at the front and rear and you are using a subwoofer specifically for the LFE.

■ Connecting the preouts

The pre-out connector used to connect the subwoofer depends on the main zone's channel setup. Connect as shown on the diagram below.

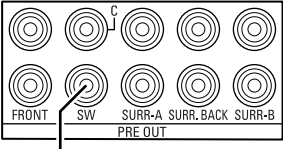
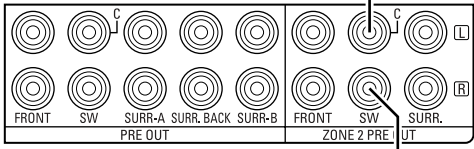
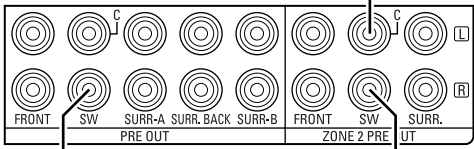
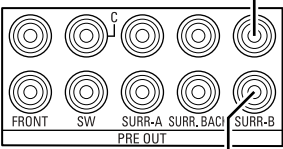
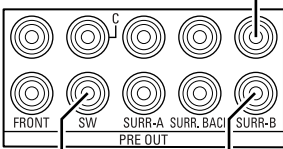
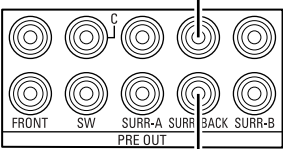
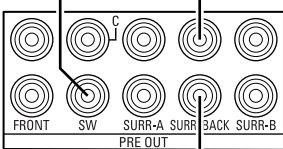
Channel Setup		Connection
Main	Subwoofer	
9.1 CH / 7.1 CH / 5.1 CH	1 SP	 <p>Subwoofer</p>
9.1 CH	2 SP	 <p>Subwoofer(L/F/M) Subwoofer(R/B/LFE)</p>
	3 SP	 <p>Subwoofer(L/F) Subwoofer(R/B)</p>
7.1 CH	2 SP	 <p>Subwoofer(L/F/M) Subwoofer(R/B/LFE)</p>
	3 SP	 <p>Subwoofer(L/F) Subwoofer(R/B)</p>
5.1 CH	2 SP	 <p>Subwoofer(L/F/M) Subwoofer(R/B/LFE)</p>
	3 SP	 <p>Subwoofer(L/F) Subwoofer(R/B)</p>

7-2. Setting the Power Amplifier Assignment

- With the AVR-5805's 10-channel power amplifier, it is possible to select 10 channels worth of signals (not including the subwoofer signals output from the pre-out connectors) to be output from the speakers. This makes it possible to put together various speaker systems. The channels can be selected freely, so "L1" to "L5" and "R1" to "R5" are indicated on the speaker terminals on the AVR-5805's rear panel.
- The channels for which the power amplifier can be assigned differ according to the channel settings made at "7-1. Channel Setup". (See pages 97~100)

■ Power amplifier assignment flow

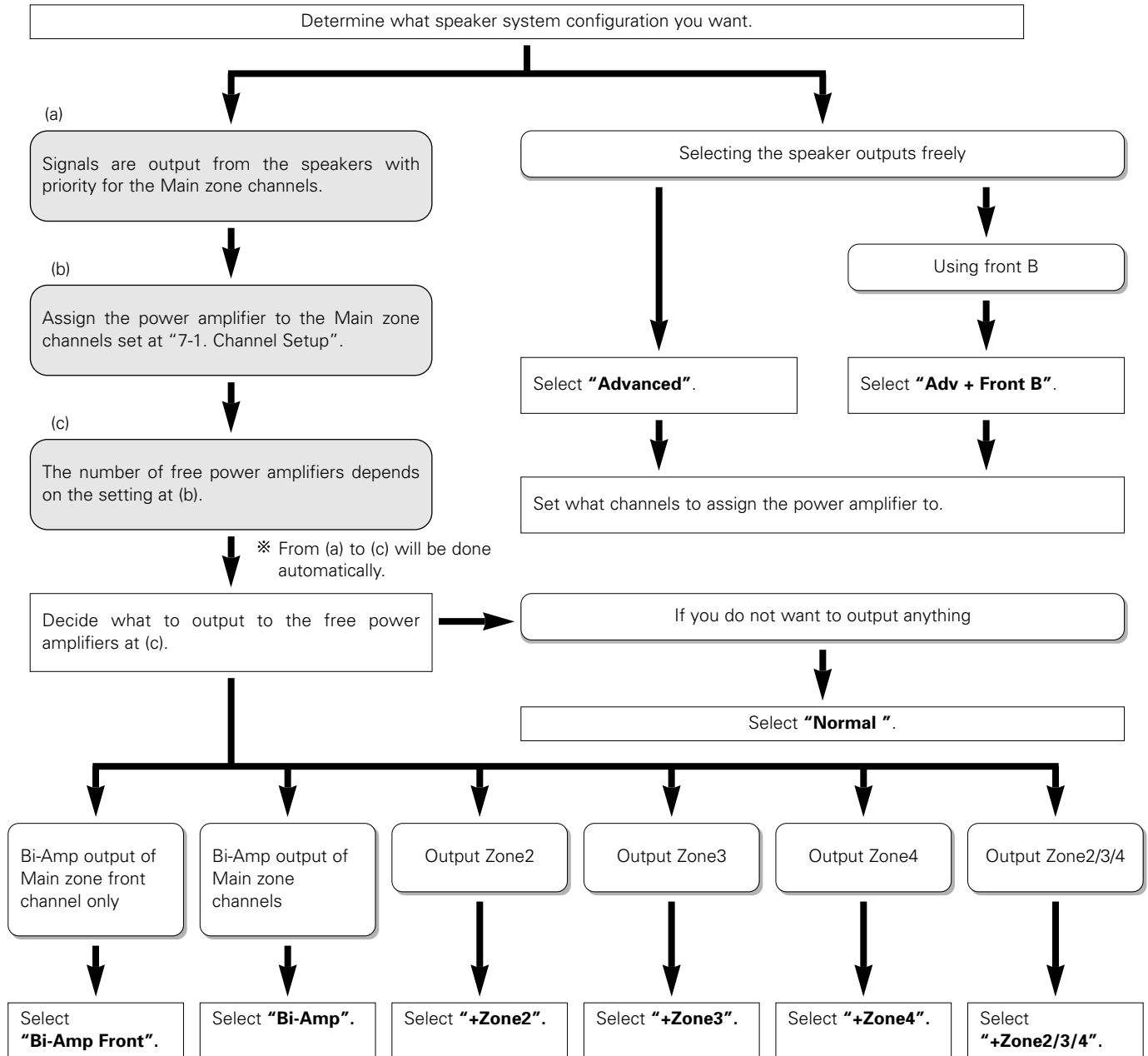

1 Select "Power Amp Assign" at the Option Setup Menu.

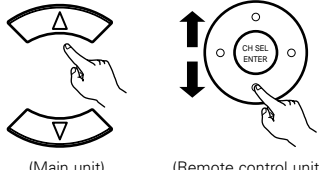

(Main unit) (Remote control unit)

*Option Setup 7.2
P.AMP Assign

7. Option Setup
1. Channel Setup
2. Power Amp Assign
3. Volume Control
4. Trigger Out
5. AC Outlet Assign
6. Setup Memory/Lock
Exit

2 Display the Power Amp Assign screen.

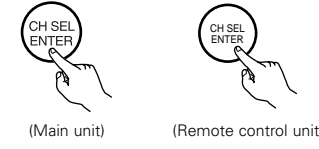

(Main unit) (Remote control unit)

*P.AMP Assign 7.2
◀ Normal ▶

SPEAKER SYSTEMS

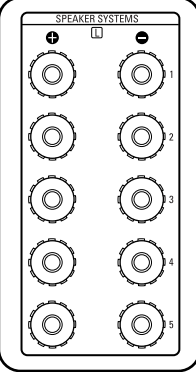

7-2. Power Amp Assign

◻ Amp Assign Mode
◀ Normal ▶

L1: FL	R1: FR
L2: C	R2: ----
L3: SL A	R3: SR A
L4: SL B	R4: SR B
L5: SBL	R5: SBR

SPEAKER SYSTEMS

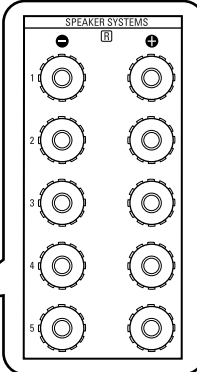

3 Select the Amp Assign mode according to the speaker system you want to achieve. One of the following modes can be selected: "Normal", "+Zone2", "+Zone3", "+Zone4", "+Zone2/3", "+Zone3/4", "+Zone2/4", "+Zone2/3/4", "Bi-Amp Front", "Bi-Amp", "Advanced" and "Adv+Front B".
* For details of the "Amp Assign Mode", see page 103.

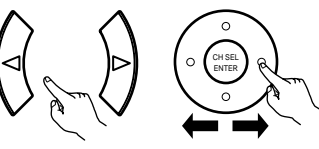

(Main unit) (Remote control unit)

NOTE:

- Selectable mode will vary, depending on the numbers of free amplifiers.

4 If "Advanced" or "Adv+Front B" is selected at step 3, the power amplifiers can be assigned freely to the desired channels.

① Select the power amplifier to be assigned. ② Select which channel to assign the power amplifier to.

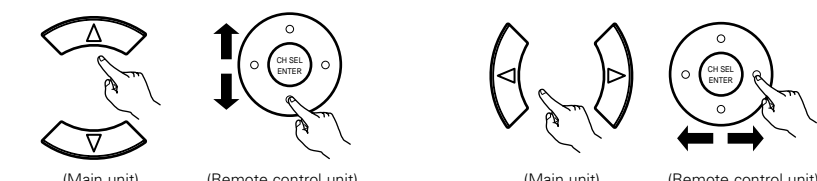

(Main unit) (Remote control unit) (Main unit) (Remote control unit)

7-2. Power Amp Assign

Amp Assign Mode
◀ Advanced ▶

◻ L1: ◀ FL ▶ R1: ◀ FR ▶
L2: ◀ C ▶ R2: ◀ ---- ▶
L3: ◀ SL A ▶ R3: ◀ SR A ▶
L4: ◀ SL B ▶ R4: ◀ SR B ▶
L5: ◀ SBL ▶ R5: ◀ SBR ▶

*P.AMP Assign 7.2
L1: ◀ FL ▶

5 Enter the setting. The Option Setup Menu reappears.

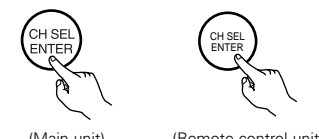

(Main unit) (Remote control unit)

■ Amp Assign mode

- Normal : This is the recommended amplifier assignment mode. Normally select this when not conducting the power amplifier assignment.
By default, this is set to "Normal".
- Advanced : With this mode, the power amplifiers can be assigned freely to the desired channels according to the speaker system you are using.
- Adv+Front B : With this mode, the power amplifiers can be assigned freely to the desired channels and front B.
- The following modes can be selected when there are power amplifiers that are free with respect to the recommended amplifier assignment ("Normal").
 - +Zone2 : This mode is the setting of the status in which the power amplifier is assigned to the Zone2 output channel.
 - +Zone3 : This mode is the setting of the status in which the power amplifier is assigned to the Zone3 output channel.
 - +Zone4 : This mode is the setting of the status in which the power amplifier is assigned to the Zone4 output channel.
 - +Zone2/3 : This mode is the setting of the status in which the power amplifier is assigned simultaneously to the Zone2 and 3 output channels.
 - +Zone3/4 : This mode is the setting of the status in which the power amplifier is assigned simultaneously to the Zone3 and 4 output channels.
 - +Zone2/4 : This mode is the setting of the status in which the power amplifier is assigned simultaneously to the Zone2 and 4 output channels.
 - +Zone2/3/4 : This mode is the setting of the status in which the power amplifier is assigned simultaneously to the Zone2, 3 and 4 output channels.
 - Bi-Amp+Front : This mode is the setting for playing the front channel with Bi-amp connections.
 - Bi-Amp : This mode is the setting for playing the front, center and surround channels with Bi-amp connections.

NOTES:

- The amplifier assignment modes that can be selected differ according to the channel settings made at "7-1. Channel Setup" (See pages 97~100).
- The status in which power amplifiers are assigned to output channels in the different amplifier assignment modes differs according to the channel settings for the different zones. (See pages 103~105)
- If the "Advanced" or "Adv+Front B" amplifier assignment mode is selected, the channels to which power amplifiers can be assigned differ according to the channel settings for the different zones. (See page 105)

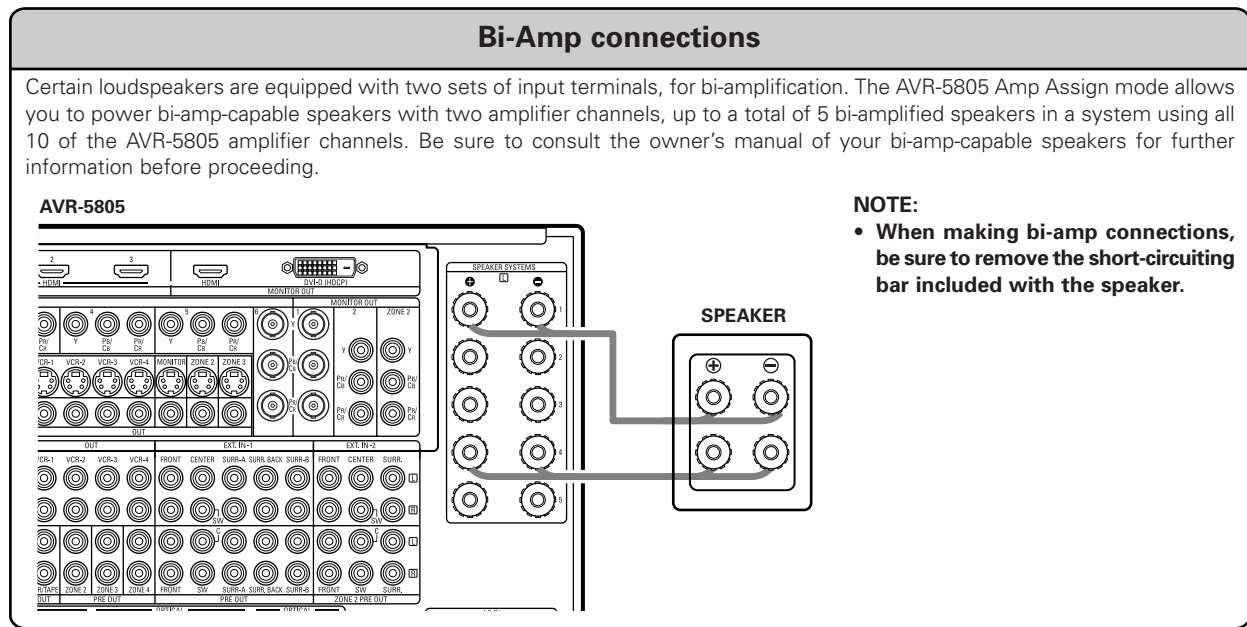

■ Table of power amplifier assignment modes with respect to the channel settings for the different zones and assignment modes

- Amp Assign mode: Normal

Channel Setup →	MAIN ZONE	9.1 CH				7.1 CH				5.1 CH			
Power Amp Assign	L1	FL	R1	FR	L1	FL	R1	FR	L1	FL	R1	FR	
	L2	C	R2	—	L2	C	R2	—	L2	C	R2	—	
	L3	SL A	R3	SR A	L3	SL A	R3	SR A	L3	SL A	R3	SR A	
	L4	SL B	R4	SR B	L4	—	R4	—	L4	—	R4	—	
	L5	SBL	R5	SBR	L5	SBL	R5	SBR	L5	—	R5	—	

- Amp Assign mode: +Zone2

Channel Setup →	MAIN ZONE	9.1 CH				7.1 CH								5.1 CH										
	ZONE2	MONO				STEREO				MONO				5.1 CH				STEREO				MONO		
Power Amp Assign	L1	FL	R1	FR	L1	FL	R1	FR	L1	FL	R1	FR	L1	FL	R1	FR	L1	FL	R1	FR	L1	FL	R1	FR
	L2	C	R2	Z2 M	L2	C	R2	–	L2	C	R2	Z2 M	L2	C	R2	Z2 C	L2	C	R2	–	L2	C	R2	Z2 M
	L3	SL A	R3	SR A	L3	SL A	R3	SR A	L3	SL A	R3	SR A	L3	SL A	R3	SR A	L3	SL A	R3	SR A	L3	SL A	R3	SR A
	L4	SL B	R4	SR B	L4	Z2 L	R4	Z2 R	L4	–	R4	–	L4	Z2 FL	R4	Z2 FR	L4	Z2 L	R4	Z2 R	L4	–	R4	–
	L5	SBL	R5	SBR	L5	SBL	R5	SBR	L5	SBL	R5	SBR	L5	Z2 SL	R5	Z2 SR	L5	–	R5	–	L5	–	R5	–

- Amp Assign mode: +Zone3

Channel Setup →	MAIN ZONE	9.1 CH				7.1 CH								5.1 CH										
	ZONE3	MONO				STEREO				MONO				STEREO				MONO						
Power Amp Assign	L1	FL	R1	FR	L1	FL	R1	FR	L1	FL	R1	FR	L1	FL	R1	FR	L1	FL	R1	FR	L1	FL	R1	FR
	L2	C	R2	Z3 M	L2	C	R2	–	L2	C	R2	Z3 M	L2	C	R2	–	L2	C	R2	Z3 M	L2	C	R2	Z3 M
	L3	SL A	R3	SR A	L3	SL A	R3	SR A	L3	SL A	R3	SR A	L3	SL A	R3	SR A	L3	SL A	R3	SR A	L3	SL A	R3	SR A
	L4	SL B	R4	SR B	L4	Z3 L	R4	Z3 R	L4	–	R4	–	L4	Z3 L	R4	Z3 R	L4	–	R4	–	L4	–	R4	–
	L5	SBL	R5	SBR	L5	SBL	R5	SBR	L5	SBL	R5	SBR	L5	–	R5	–	L5	–	R5	–	L5	–	R5	–

- Amp Assign mode: +Zone4

Channel Setup →	MAIN ZONE	9.1 CH				7.1 CH								5.1 CH										
	ZONE4	MONO				STEREO				MONO				STEREO				MONO						
Power Amp Assign	L1	FL	R1	FR	L1	FL	R1	FR	L1	FL	R1	FR	L1	FL	R1	FR	L1	FL	R1	FR	L1	FL	R1	FR
	L2	C	R2	Z4 M	L2	C	R2	–	L2	C	R2	Z4 M	L2	C	R2	–	L2	C	R2	Z4 M	L2	C	R2	Z4 M
	L3	SL A	R3	SR A	L3	SL A	R3	SR A	L3	SL A	R3	SR A	L3	SL A	R3	SR A	L3	SL A	R3	SR A	L3	SL A	R3	SR A
	L4	SL B	R4	SR B	L4	Z4 L	R4	Z4 R	L4	–	R4	–	L4	Z4 L	R4	Z4 R	L4	–	R4	–	L4	–	R4	–
	L5	SBL	R5	SBR	L5	SBL	R5	SBR	L5	SBL	R5	SBR	L5	–	R5	–	L5	–	R5	–	L5	–	R5	–

- Amp Assign mode: +Zone2/3

Channel Setup →	MAIN ZONE	7.1 CH												5.1 CH															
	ZONE2	STEREO				MONO				MONO				STEREO				STEREO				MONO				MONO			
	ZONE3	MONO				STEREO				MONO				STEREO				MONO				STEREO				MONO			
Power Amp Assign	L1	FL	R1	FR	L1	FL	R1	FR	L1	FL	R1	FR	L1	FL	R1	FR	L1	FL	R1	FR	L1	FL	R1	FR	L1	FL	R1	FR	
	L2	C	R2	Z3 M	L2	C	R2	Z2 M	L2	C	R2	Z3 M	L2	C	R2	–	L2	C	R2	Z3 M	L2	C	R2	Z2 M	L2	C	R2	Z3 M	
	L3	SL A	R3	SR A	L3	SL A	R3	SR A	L3	SL A	R3	SR A	L3	SL A	R3	SR A	L3	SL A	R3	SR A	L3	SL A	R3	SR A	L3	SL A	R3	SR A	
	L4	Z2 L	R4	Z2 R	L4	Z3 L	R4	Z3 R	L4	Z2 M	R4	–	L4	Z2 L	R4	Z2 R	L4	Z2 L	R4	Z2 R	L4	Z3 L	R4	Z3 R	L4	Z2 M	R4	–	
	L5	SBL	R5	SBR	L5	SBL	R5	SBR	L5	SBL	R5	SBR	L5	Z3 L	R5	Z3 R	L5	–	R5	–	L5	–	R5	–	L5	–	R5	–	

- Amp Assign mode: +Zone3/4

Channel Setup →	MAIN ZONE	7.1 CH												5.1 CH															
	ZONE3	STEREO				MONO				MONO				STEREO				STEREO				MONO				MONO			
	ZONE4	MONO				STEREO				MONO				STEREO				MONO				STEREO				MONO			
Power Amp Assign	L1	FL	R1	FR	L1	FL	R1	FR	L1	FL	R1	FR	L1	FL	R1	FR	L1	FL	R1	FR	L1	FL	R1	FR	L1	FL	R1	FR	
	L2	C	R2	Z4 M	L2	C	R2	Z3 M	L2	C	R2	Z4 M	L2	C	R2	–	L2	C	R2	Z4 M	L2	C	R2	Z3 M	L2	C	R2	Z4 M	
	L3	SL A	R3	SR A	L3	SL A	R3	SR A	L3	SL A	R3	SR A	L3	SL A	R3	SR A	L3	SL A	R3	SR A	L3	SL A	R3	SR A	L3	SL A	R3	SR A	
	L4	Z3 L	R4	Z3 R	L4	Z4 L	R4	Z4 R	L4	Z3 M	R4	–	L4	Z3 L	R4	Z3 R	L4	Z3 L	R4	Z3 R	L4	Z4 L	R4	Z4 R	L4	Z3 M	R4	–	
	L5	SBL	R5	SBR	L5	SBL	R5	SBR	L5	SBL	R5	SBR	L5	Z4 L	R5	Z4 R	L5	–	R5	–	L5	–	R5	–	L5	–	R5	–	

- Amp Assign mode: +Zone2/4

Channel Setup →	MAIN ZONE	7.1 CH												5.1 CH															
	ZONE2	STEREO				MONO				MONO				STEREO				STEREO				MONO				MONO			
	ZONE4	STEREO				STEREO				MONO				STEREO				MONO				STEREO				MONO			
Power Amp Assign	L1	FL	R1	FR	L1	FL	R1	FR	L1	FL	R1	FR	L1	FL	R1	FR	L1	FL	R1	FR	L1	FL	R1	FR	L1	FL	R1	FR	
	L2	C	R2	Z3 M	L2	C	R2	Z2 M	L2	C	R2	Z3 M	L2	C	R2	–	L2	C	R2	Z4 M	L2	C	R2	Z2 M	L2	C	R2	Z4 M	
	L3	SL A	R3	SR A	L3	SL A	R3	SR A	L3	SL A	R3	SR A	L3	SL A	R3	SR A	L3	SL A	R3	SR A	L3	SL A	R3	SR A	L3	SL A	R3	SR A	
	L4	Z2 L	R4	Z2 R	L4	Z3 L	R4	Z3 R	L4	Z2 M	R4	–	L4	Z2 L	R4	Z2 R	L4	Z2 L	R4	Z2 R	L4	Z4 L	R4	Z4 R	L4	Z2 M	R4	–	
	L5	SBL	R5	SBR	L5	SBL	R5	SBR	L5	SBL	R5	SBR	L5	Z4 L	R5	Z4 R	L5	–	R5	–	L5	–	R5	–	L5	–	R5	–	

7-3. Setting the Volume Control

- Set the upper limit for the volume, the volume level when the power is turned on, and the volume level when the mute mode is set for the different zones.

1 Select "Volume Control" at the Option Setup Menu.

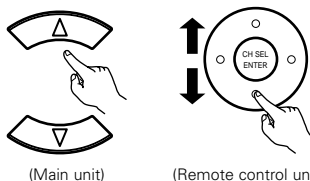

(Main unit)

(Remote control unit)

```
*Option Setup
Volume Control
```

```
7. Option Setup
1. Channel Setup
2. Power Amp Assign
3. Volume Control
4. Trigger Out
5. AC Outlet Assign
6. Setup Memory/Lock
Exit
```

2 Display the Volume Control screen.

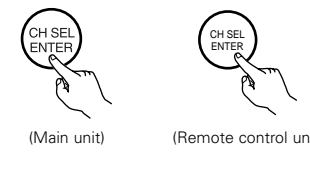

(Main unit)

(Remote control unit)

```
*Volume :Main
Limit :4 OFF
```

```
7-3. Volume Control
Main Vol. Limit < OFF >
P. On Lev. LAST >
Mute Lev. < FULL >
Zone2 Vol. Lev. < VAR >
Vol. Limit < OFF >
P. On Lev. LAST >
Mute Lev. < FULL >
```

3 Make the volume restriction settings for the different zones.

- ① Select the desired setting.

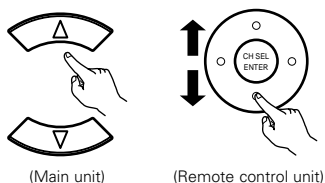

- ② Select the parameter.

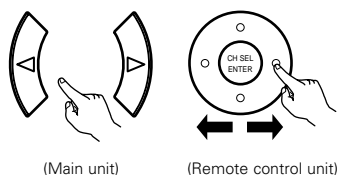

```
7-3. Volume Control
Main Vol. Limit < OFF >
P. On Lev. LAST >
Mute Lev. < FULL >
Zone2 Vol. Lev. < VAR >
Vol. Limit < OFF >
P. On Lev. LAST >
Mute Lev. < FULL >
```

```
7-3. Volume Control
Zone3 Vol. Lev. < VAR >
Vol. Limit < OFF >
P. On Lev. LAST >
Mute Lev. < FULL >
Zone4 Vol. Lev. < VAR >
Vol. Limit < OFF >
P. On Lev. LAST >
Mute Lev. < FULL >
```

Volume Limit: Set the upper limit for the volume for the different zones.

-20 dB, -10 dB, 0 dB : The volume cannot be increased above the selected levels.

OFF : If you do not want to set a volume limit, select "OFF".

In this case, the volume can be set to the AVR-5805's maximum volume (output) level of +18 dB, which is extremely loud.

Power On Level: Set the volume that is set when the power is turned on for the different zones.

You can adjust the volume level within the range of -80 to +18 dB in steps of 1.0 dB.

--- (Mute) : The volume is always muted when the power is turned on.

LAST : The volume set when the AVR-5805 was last used is stored in the memory and set when the power is turned on.

Mute Level: Set the volume attenuation level when the mute mode is set for the different zones.

FULL : The volume is fully muted.

-40 dB : The volume is lowered 40 dB from the current level.

-20 dB : The volume is lowered 20 dB from the current level.

Volume Level: Set whether to fix the output level for the different zones or make it variable.

Variable : The level can be adjusted freely using buttons on the Remote control unit.

-40 dB, 0 dB : The output level is fixed at the set level and the volume can no longer be adjusted.

NOTES:

- For Zone2, Zone3 and Zone4, the "Volume Limit", "Power On Level" and "Mute Level" can be set when "Variable" is selected for "Volume Level".
- When the power amplifier is assigned to either of the Zone2, Zone3 and Zone4 channels at "7-2. Power Amp Assign", "-VAR-" (only variable) is displayed and the fixed level cannot be set.

4



(Main unit)



(Remote control unit)

Enter the setting.
The Option Setup Menu reappears.

7-4. Setting the Trigger Out

- Four 12 V DC Trigger Outputs on the rear panel can be used to control other devices with compatible trigger inputs, such as motorized screens, motorized screen masking, motorized drapes, and other trigger-controlled devices.
- Set the DC output supplied from the trigger out jacks for the various input sources to ON or OFF.

1

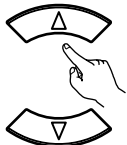

(Main unit)

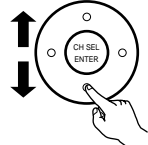

(Remote control unit)

Select "Trigger Out" at the Option Setup Menu.

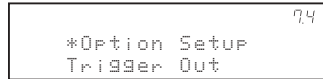

7. Option Setup

1. Channel Setup
2. Power Amp Assign
3. Volume Control
4. Trigger Out
5. AC Outlet Assign
6. Setup Memory/Lock

Exit

2



(Main unit)



(Remote control unit)

Display the Trigger Out screen.

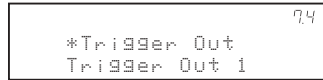

7-4. Trigger Out

- Trigger Out 1
- Trigger Out 2
- Trigger Out 3
- Trigger Out 4

Default Yes

Exit

3

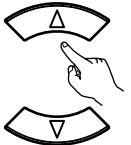

(Main unit)



(Main unit)

Select the trigger out jack you want to set.
Switch to the setting screen.



7-4. Trigger Out 1

ZONE : MAIN

Tuner	: OFF	DBS	: ON
Phone	: OFF	VCR-1	: ON
CD	: OFF	VCR-2	: ON
Tape	: OFF	VCR-3	: ON
DVD	: ON	VCR-4	: ON
VDP	: ON	V.Aux	: ON
TV	: ON	Surr. Mode	: ON

Example: When "Trigger Out 1" is selected

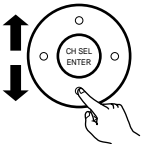

(Remote control unit)

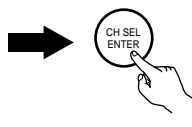

(Remote control unit)

4

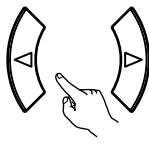

(Main unit)

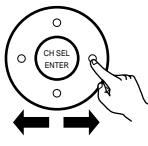

(Remote control unit)

Select the Zone. (MAIN ZONE, ZONE2, ZONE3 and ZONE4)

The power supplied from the trigger out jack turns on and off when the power for the set zone is turned on and off.

5

① Select the input source.

② Select "ON" or "OFF".

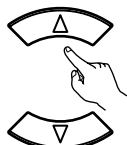

(Main unit)

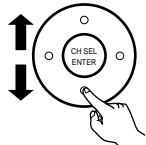

(Remote control unit)

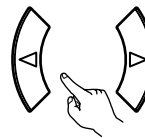

(Main unit)

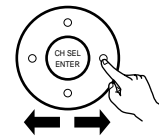

(Remote control unit)

- ON** : When that input source is selected, the power supplied from the trigger out jack turns on.
- OFF** : When that input source is selected, the power supplied from the trigger out jack turns off.

6 If "MAIN" was selected at step 4, the trigger out jack's output setting can also be made for the various surround modes.

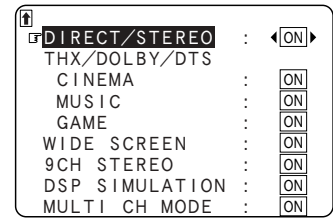
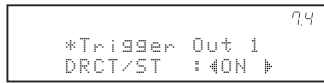

① Select the surround mode.

② Select "ON" or "OFF".

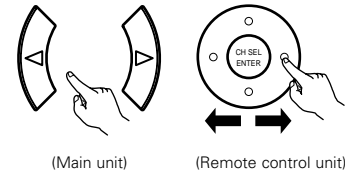
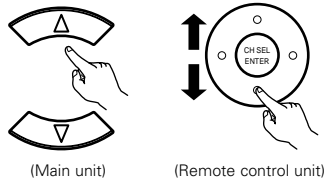

ON : If that surround mode is selected when an input source set to "ON" is selected, the power supplied from the trigger out jack turns on.

OFF : If that surround mode is selected when an input source set to "ON" is selected, the power supplied from the trigger out jack turns off.

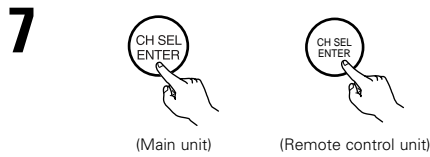

Press the ENTER button to return to the Trigger Out screen.

※ Use the same procedure to make the settings for Trigger Out 2, 3, 4.

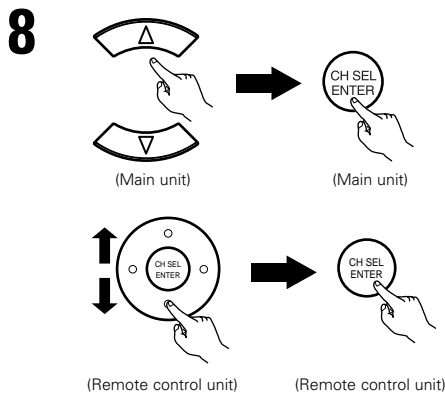

Select "Exit" then press the ENTER button at the Trigger Out screen.
The Option Setup Menu reappears.

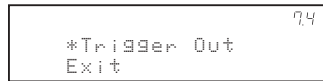

※ If "Yes" is selected for "Default", the settings are automatically reset to the default values.

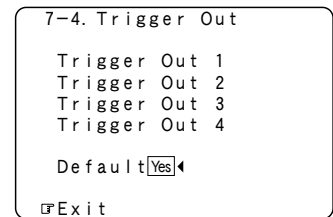

7-5. Setting the AC Outlet Assign

- Set the power of the three AC outlets on the AVR-5805's rear panel to ON or OFF with respect to the different input sources.

1

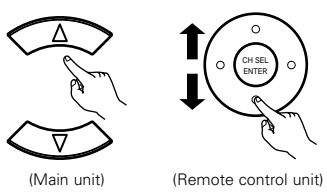

(Main unit) (Remote control unit)

Select "AC Outlet Assign" at the Option Setup Menu.

```
*Option Setup 7.5
AC Outlet
```

```
7. Option Setup
1. Channel Setup
2. Power Amp Assign
3. Volume Control
4. Trigger Out
5. AC Outlet Assign
6. Setup Memory/Lock
Exit
```

2

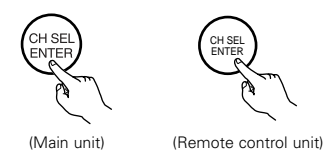

(Main unit) (Remote control unit)

Display the AC Outlet Assign screen.

```
*AC Outlet 7.5
AC Outlet 1
```

```
7-5. AC Outlet
AC Outlet 1
AC Outlet 2
AC Outlet 3

Default Yes
Exit
```

3

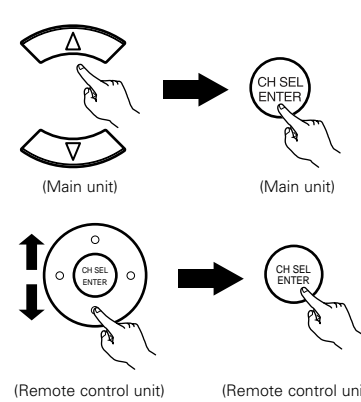

(Main unit) (Main unit)

(Remote control unit) (Remote control unit)

Select the AC outlet you want to set.
Switch to the setting screen.

```
*AC Outlet 1 7.5
ZONE : MAIN
```

```
7-5. AC Outlet 1
ZONE : MAIN
Tuner : ON DBS : ON
Phono : ON VCR-1 : ON
CD : ON VCR-2 : ON
Tape : ON VCR-3 : ON
DVD : ON VCR-4 : ON
VDP : ON V.Aux : ON
TV : ON
```

Example: When "AC Outlet 1" is selected

4

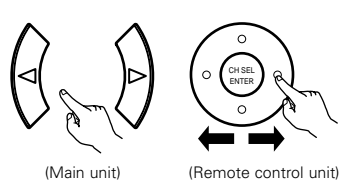

(Main unit) (Remote control unit)

Select the Zone. (MAIN ZONE, ZONE2, ZONE3 and ZONE4)
The power of the AC outlet turns on and off when the power for the set zone is turned on and off.

5

① Select the input source.

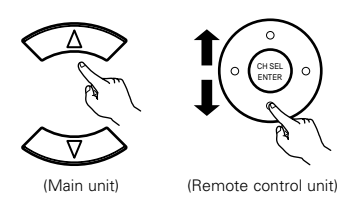

(Main unit) (Remote control unit)

② Select "ON" or "OFF".

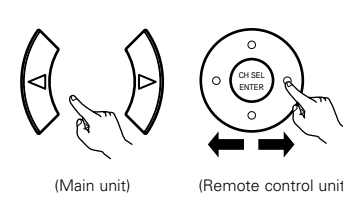

(Main unit) (Remote control unit)

ON : The power of the AC outlet turns on when that input source is selected.
OFF : The power of the AC outlet turns off when that input source is selected.

6

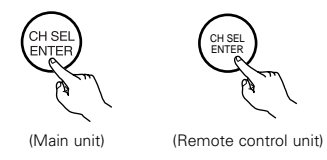

(Main unit) (Remote control unit)

Press the ENTER button to return to the AC Outlet Assign screen.

※ Use the same procedure to make the settings for AC Outlet 2, 3.

7

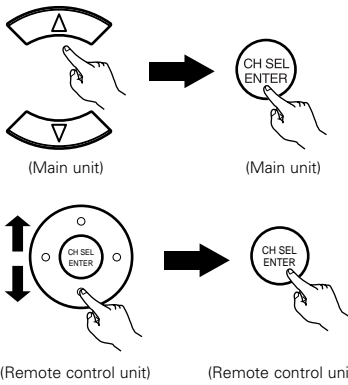

Select "Exit" then press the ENTER button at the AC Outlet screen.
The Option Setup Menu reappears.

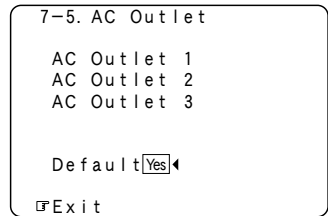
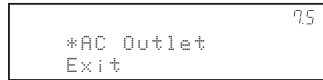

※ If "Yes" is selected for "Default", the settings are automatically reset to the default values.

7-6. Protecting the setting and memory backup

[1] User Memory

- The currently set settings (system setup, surround parameters, etc.) can be stored in the memory. The stored settings can be called out when needed.

1

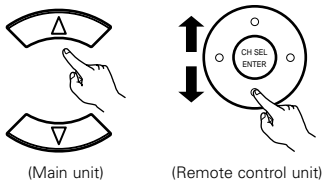

Select "Setup Memory / Lock" at the Option Setup Menu.

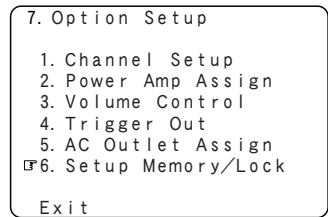
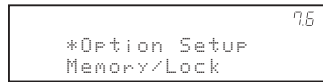

2

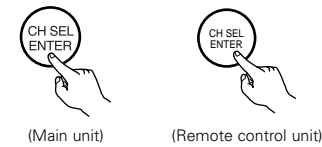

Display the Setup Memory / Lock screen.

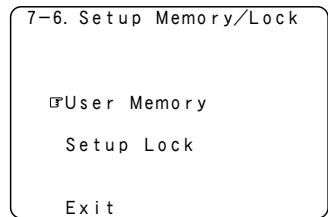
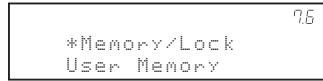

3

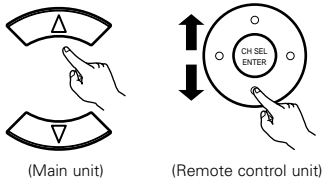

Select "User Memory" at the Setup Memory / Lock screen.

4

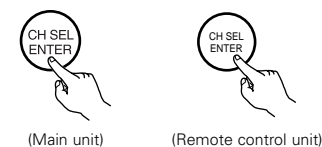

Switch to the User Memory screen.

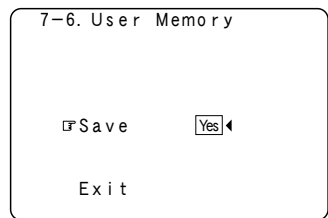
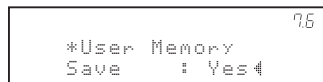

5

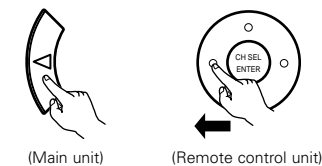

To store the settings in the memory, select "Yes".

※ Once the settings are stored in the memory, "Load" is displayed and the settings can be loaded.

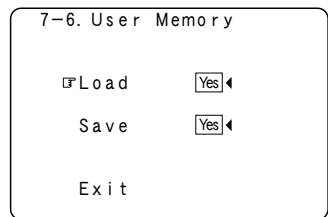

6

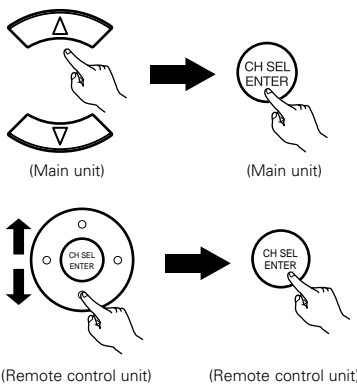

Select "Exit" and press the ENTER button to return to the Setup Memory / Lock screen.

[2] Setup Lock

- The system setup settings can be locked so that they cannot be changed easily.

1

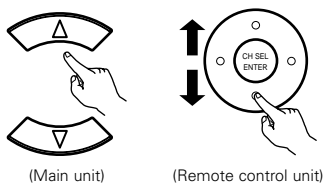

Select "Setup Lock" at the Setup Memory / Lock screen.

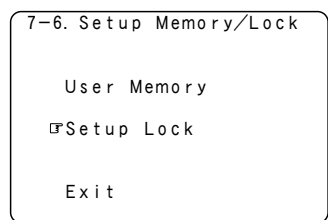
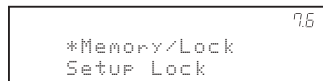

2

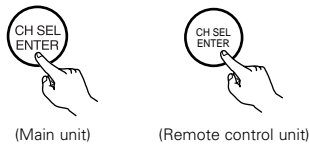

Switch to the Setup Lock screen.

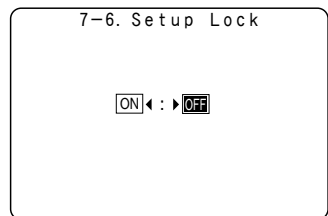
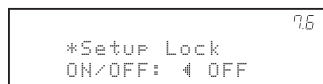

3

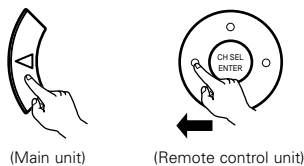

Select "ON", to lock the system setup settings.

4

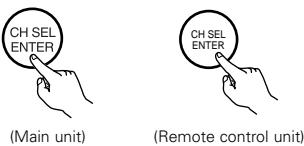

Press the ENTER button to return to the Setup Memory / Lock screen.

5

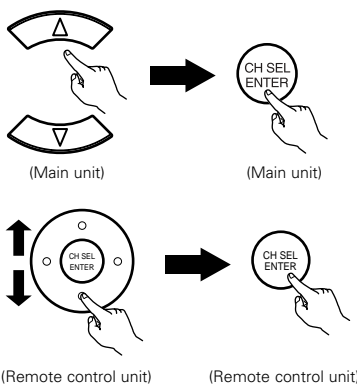

Select "Exit" and press the ENTER button at the Setup Memory / Lock screen. The Option Setup Menu reappears.

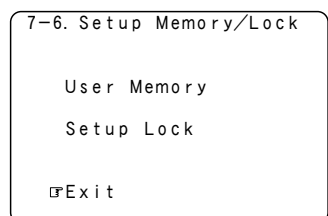
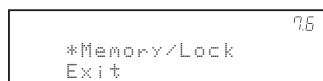

6

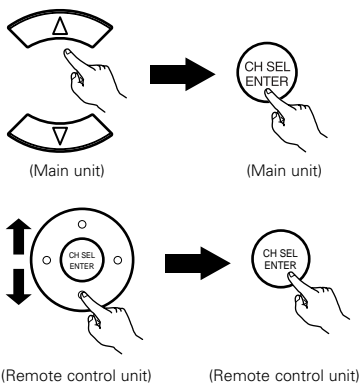

Select "Exit" and press the ENTER button to finalize the setting and exit the Option Setup mode. When the setup lock function is activated, the settings listed below cannot be changed, and "Setup Locked" is displayed when related buttons are operated.

- System setup settings
- Surround parameter settings
- Tone control settings
- Channel level settings (including test tones)
- RoomEQ

To unlock, press the System Setup button again and display the Setup Lock screen, then select "OFF" and press the ENTER button.

7. Option Setup

 1. Channel Setup
 2. Power Amp Assign
 3. Volume Control
 4. Trigger Out
 5. AC Outlet Assign
 6. Setup Memory/Lock

☐Exit



※ System setup is complete. Once these settings are made, there is no need to change them unless different AV components are connected or the speakers are repositioned.

After completing system setup

This button can be pressed at any time during the system setup process to complete the process.

1

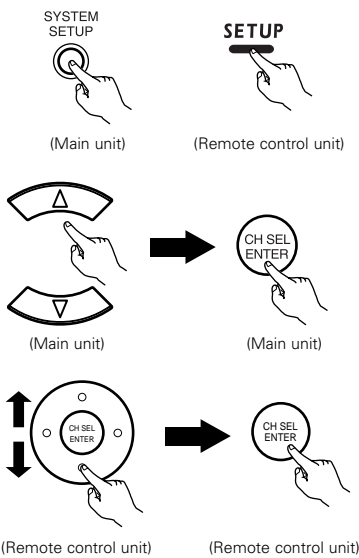

Press the SYSTEM SETUP button at the System Setup Menu, or select "Exit" and press the ENTER button.

※ The changed settings are entered and the on-screen display turns off.

- System Setup Menu

 1. Auto Setup/Room EQ
 2. Speaker Setup
 3. Audio Input Setup
 4. Video Setup
 5. Advanced Playback
 6. Zone Setup
 7. Option Setup

☐Exit

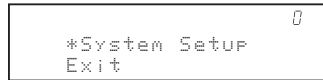

■ On-screen display for component video outputs

- When viewing component video signals via the AVR-5805, the on-screen display is only displayed on the monitor when the "System Setup" and "Surround Parameter" operations are performed and when the Remote control unit's ON SCREEN button is operated.
- When only component video signals are input to the AVR-5805 or when "Component" is selected at the "Video Convert Mode settings", the characters of the on-screen display are not displayed over the picture.

8 REMOTE CONTROL UNIT

- The included Remote control unit (RC-995) can be used to operate not only the AVR-5805 but other remote control compatible DENON components as well. In addition, the memory contains the control signals for other Remote control units, so it can be used to operate non-Denon remote control compatible products.

Inserting the Batteries

- ① Remove the Remote control unit's rear cover.

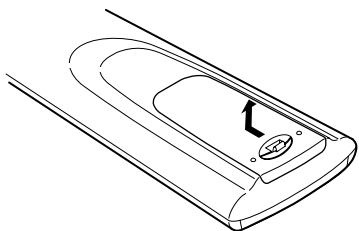

- ② Set three R03/AAA batteries in the battery compartment in the indicated direction.

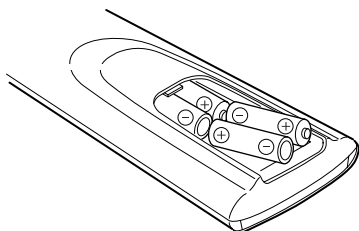

- ③ Put the rear cover back on.

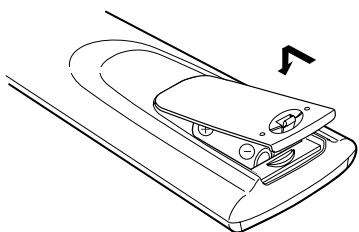

Notes on Batteries

- Use R03/AAA alkaline batteries in the Remote control unit.
- Replace the batteries with new ones if the set does not operate even when the Remote control unit is operated nearby the set. (The included battery is only for verifying operation.)
- When inserting the batteries, be sure to do so in the proper direction, following the "⊕" and "⊖" marks in the battery compartment.
- To prevent damage or leakage of battery fluid:
 - Do not use a new battery together with an old one.
 - Do not use two different types of batteries.
 - Do not short-circuit, disassemble, heat or dispose of batteries in flames.
- Remove the batteries from the Remote control unit when you do not plan to use it for an extended period of time.
- If the battery fluid should leak, carefully wipe the fluid off the inside of the battery compartment and insert new batteries.
- When replacing the batteries, have the new batteries ready and insert them as quickly as possible.

Using the Remote Control Unit

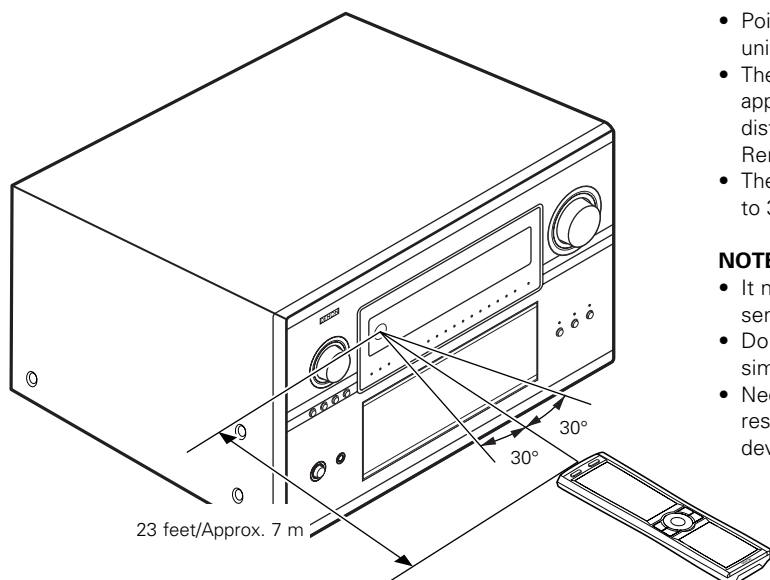

- Point the Remote control unit at the remote sensor on the Main unit as shown on the diagram.
- The Remote control unit can be used from a straight distance of approximately 23 feet/7 meters from the Main unit, but this distance will be shorter if there are obstacles in the way or if the Remote control unit is not pointed directly at the remote sensor.
- The Remote control unit can be operated at a horizontal angle of up to 30 degrees with respect to the remote sensor.

NOTES:

- It may be difficult to operate the Remote control unit if the remote sensor is exposed to direct sunlight or strong artificial light.
- Do not press buttons on the Main unit and Remote control unit simultaneously. Doing so may result in malfunction.
- Neon signs or other devices emitting pulse-type noise nearby may result in malfunction, so keep the set as far away from such devices as possible.

Operating DENON audio components

1 Use the mode selector buttons to select the component you want to operate.

* The function switches as shown below each time one of the mode buttons is pressed.

- AMP/Z2 : AMP, ZONE2
- Z3/Z4 : ZONE3, ZONE4
- TUN/D-TU : TUNER, D-TUNER*
- CD/CDR : CD, CDR
- TV/DBS : TV, DBS
- VCR1/VCR2 : VCR1, VCR2
- VDP : VDP
- DVD/DVDR : DVD, DVDR

* This mode is for future use.

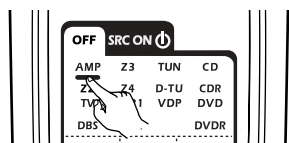

Example : Select "AMP" mode. Select "ZONE2" mode.

AMP

Z2

2 Operate the audio component.
 • For details, refer to the component's operating instructions.
 * It may not be possible to operate some models.

3 [SOURCE MENU]
 • Operate the source.

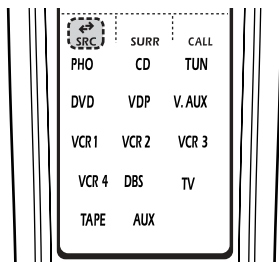

[SURROUND MENU]
 • Operate the surround mode.

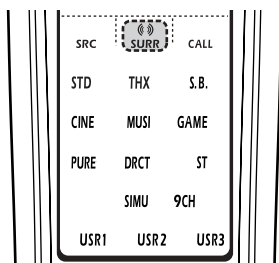

[10KEY / SYSTEM CALL MENU]
 • Operate the 10KEY or SYSTEM CALL mode.

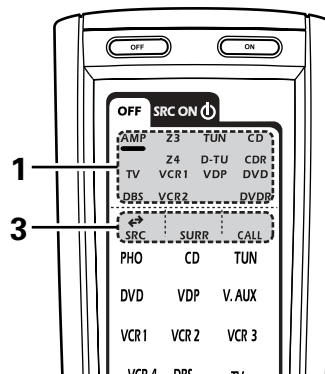
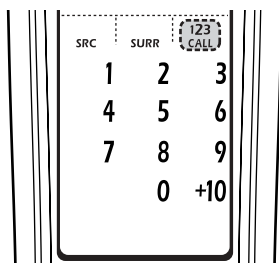

1. CD player (CD) system buttons

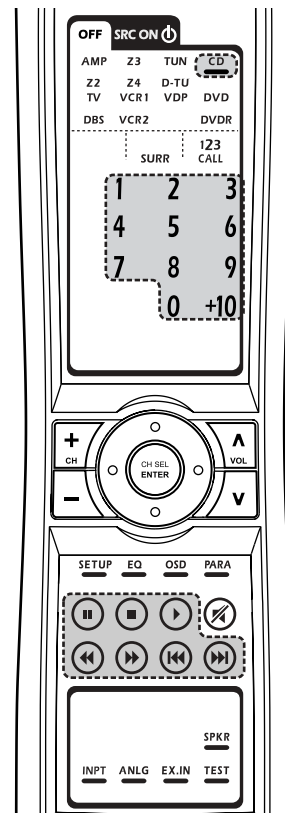

- ◀▶ : Manual search (forward and reverse)
- : Stop
- ▶ : Play
- ◀▶▶▶ : Auto search (to beginning of track)
- ⏸ : Pause
- 0~9, +10 : 10 Key

2. CD recorder (CDR), MD recorder (MD), Tape deck (TAPE) system buttons

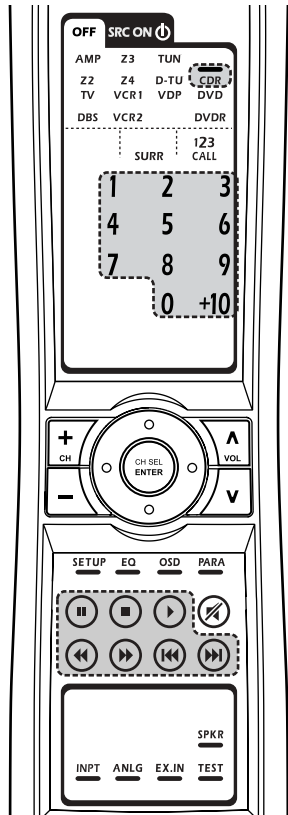

- ◀▶ : Manual search (forward and reverse)
- : Stop
- ▶ : Play
- ◀▶▶▶ : Auto search (to beginning of track)
- ⏸ : Pause
- 0-9, +10 : 10 Key

3. Tuner system buttons

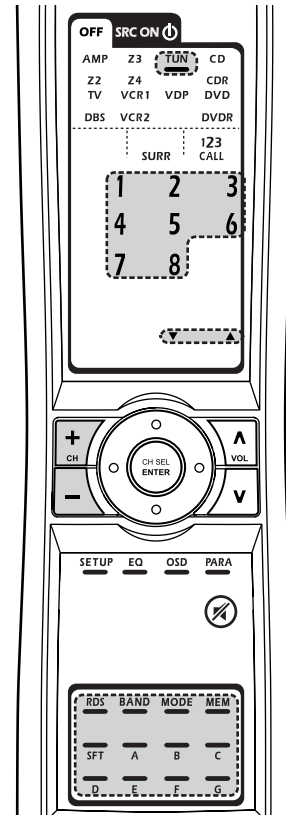

- TUNING ▲, ▼ : Tuning up/down
- BAND : Switch between AM and FM bands
- MODE : Switch between AUTO and MANUAL
- MEM : Preset memory
- SFT : Switch preset channel range
- CHANNEL +, - : Preset channel up/down
- CH A~G : Preset channel range
- 1~8 : Preset channel
- RDS : RDS search

※ The preset codes of an MD or tape player can be recorded in the CDR mode so that the MD or tape player can be operated. (See page 116)
It is only possible to set the preset memory for one player (CDR, MD or TAPE).

Preset memory

The included Remote control unit can be used to operate devices of different brands by registering the preset number corresponding to the brand of your device.

For some models the Remote control unit or the device may not operate properly. In this case, use the learning function (page 119) to store your device's remote control signals in the included Remote control unit.

For instructions on resetting the preset memory, see page 123.

- 1** Press the power ON button and the OFF button at the same time.



- 2** Press the "1" button to select preset memory.

- Setup List
 - 1: Preset memory
 - 2: Learning setup
 - 3: System call
 - 4: Punch through
 - 5: Light setup
 - 6: Reset

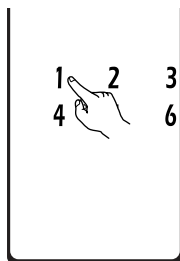

- 3** Press the Mode button for the component you want to preset, then press ENTER button.

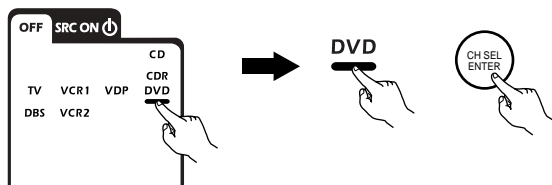

- 4** Referring to the included List of Preset Codes, use the number buttons to input the preset code (a 4-digit number) for the manufacturer of the component whose signals you want to store in the memory.

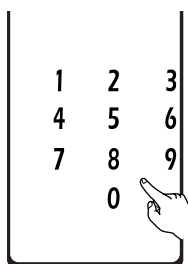

- 5** "OK" is displayed when the signals are registered and the mode is terminated. "FAIL" is displayed when the signals are not registered, repeat steps 1 to 5.

- 6** To store the codes of another component in the memory, repeat steps 1 to 5.

NOTES:

- Depending on the model and year of manufacture, this function cannot be used for some models, even if the your device is listed on the included list of preset codes.
- Some manufacturers use more than one type of remote control code. Refer to the included list of preset codes to change the number and check it out.

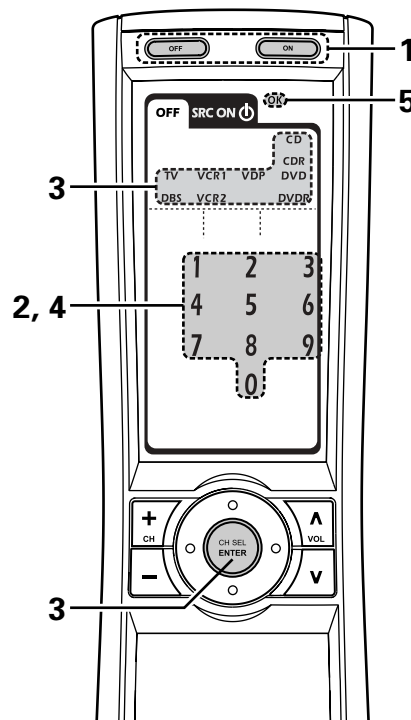

The preset codes are as follows upon shipment from the factory and after resetting:

TV, VCR1HITACHI
 CD, CDR, VDP, DVD, DVDRDENON
 VCR2, DBS.....SONY

DVD preset codes	0000 (default)	0517
DENON Model No.	DVD-555	DVD-800
	DVD-755	DVD-1600
	DVD-900	DVD-2000
	DVD-910	DVD-2500
	DVD-955	DVD-3000
	DVD-1000	DVD-3300
	DVD-1200	
	DVD-1500	
	DVD-1710	
	DVD-1910	
	DVD-2200	
	DVD-2800	
	DVD-2800II	
	DVD-2900	
	DVD-2910	
	DVD-3800	
	DVD-3910	
	DVD-5900	
	DVD-9000	
	DVM-715	
	DVM-1800	
	DVM-1805	
	DVM-1815	
	DVM-2815	
	DVM-4800	

Operating a component stored in the preset memory

- 1** Press the mode selector button for the component you want to operate.

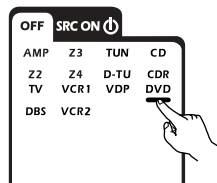

NOTE:

- For the DVD player remote control buttons, function names may differ according to manufacturer. Compare with the remote control operation of the various components.

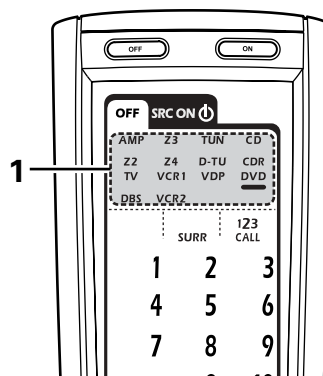

- 2** Operate the component.
- For details, refer to the component's operating instructions.
 - ※ Some models cannot be operated with this Remote control unit.

1. DVD player (DVD), DVD recorder (DVD R) system buttons

- SRC ON : Power on
- OFF : Power off (DENON DVD only)
- ◀▶ : Manual search (forward and reverse)
- : Stop
- ▶ : Play
- ◀▶ : Auto search (to beginning of track)
- ⏸ : Pause
- SETUP : Setup
- TOP : Top menu
- MENU : Menu
- RTN : Return
- ▲▼◀▶ : Cursor up, down, left and right
- ENTER : Enter
- AUD : Switch the audio language
- DISP : Display
- SUB : Switch the subtitle
- AGL : Switch the angle
- 0-9, +10 : 10 key

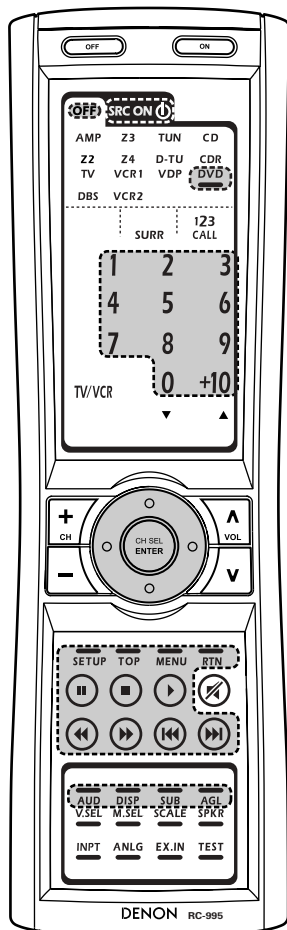

2. Video disc player (VDP) system buttons

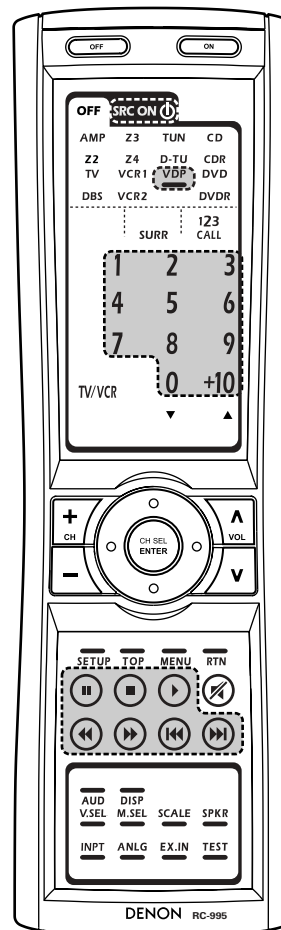

- SRC ON : Power on/Standby
- ◀▶ : Manual search (forward and reverse)
- : Stop
- ▶ : Play
- ◀▶ : Auto search (cue)
- ⏸ : Pause
- 0-9, +10 : 10 key

3. Video deck (VCR-1/VCR-2) system buttons

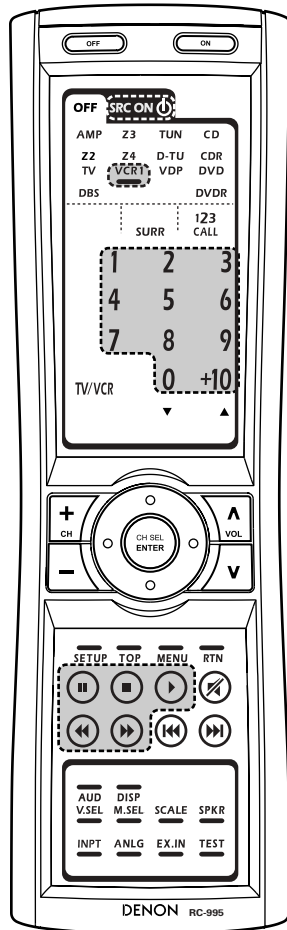

- SRC ON : Power on/Standby
- ◀▶ : Manual search (forward and reverse)
- : Stop
- ▶ : Play
- ⏸ : Pause
- 0-9, +10 : 10 key

4. Monitor TV (TV),digital broadcast satellite (DBS) tuner and cable (CABLE) system buttons

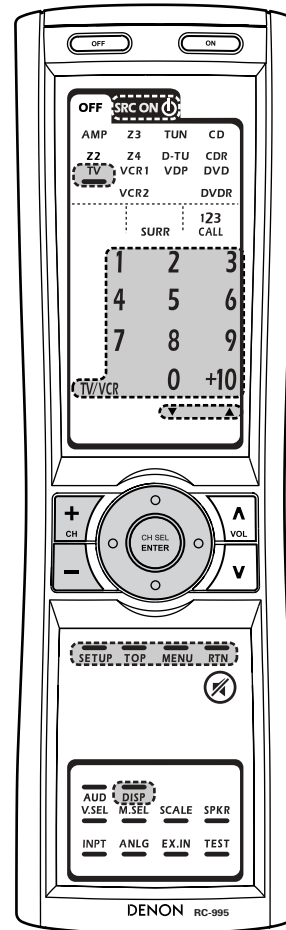

- SRC ON : Power on/standby
- SETUP : Setup
- TOP : Top menu
- MENU : Menu
- RTN : Return
- ▲, ▼, ◀, ▶ : Cursor up,down,left and right
- ENTER : Enter
- DISP : Switch display
- Channel +, - : Switch channels +,-
- 0-9, +10 : 10 key
- TV/VCR : Switch between TV and video player
- VOL ▲, ▼ : Volume up/down

※ The preset codes of cable box decoder can be recorded in the DBS mode so that the cable device can be operated. (See page 116)
It is only possible to set the preset memory for either the DBS or cable device.

Learning function

If an AV component is not a DENON product, or if it cannot be operated via codes provided in the AVR-5805 remote control's internal preset memory, or if its codes cannot be successfully learned by the AVR-5805 remote control, then you should use the remote control that was supplied with that AV component to operate the component.

- 1** Press the power ON button and the OFF button simultaneously.



- 2** Press the "2" button to select Learning setup.

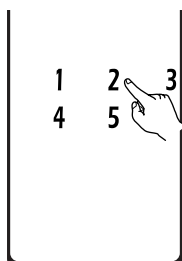

- 3** Press the Mode button for the component you want to learned, then press the ENTER button. Learning is not possible for the AMP, ZONE2, ZONE3 and ZONE4 modes.

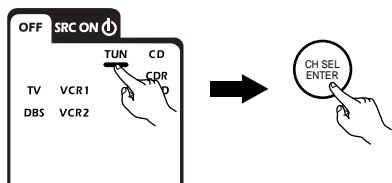

- 4** Buttons that allow learning will light. Press the button that you wish to be learned. **The display will go off and the unit will enter the learning standby mode.**

- To cancel, press the power ON button and the OFF button simultaneously.

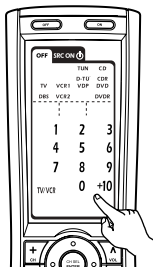

- 5** Point the Remote control units directly at each other and press and hold in the button on the other Remote control unit which you want to "learn".

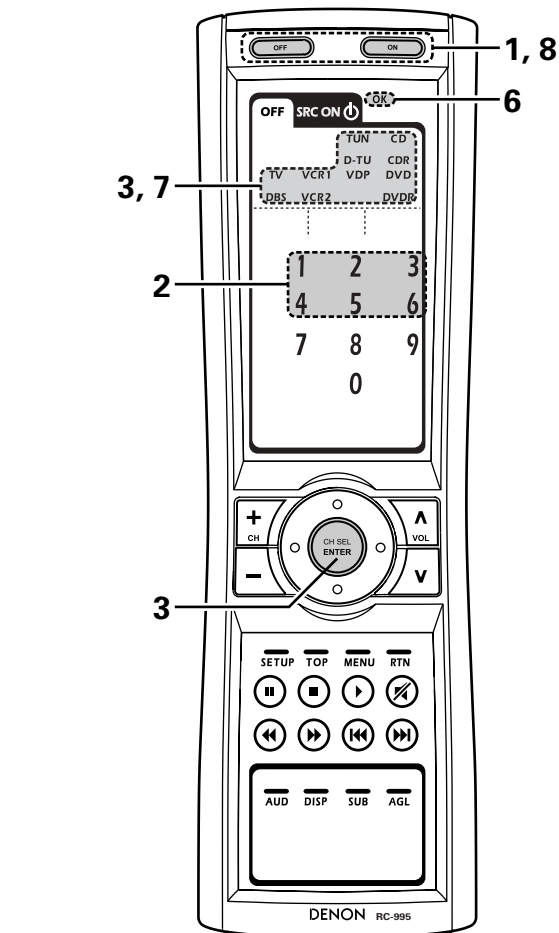
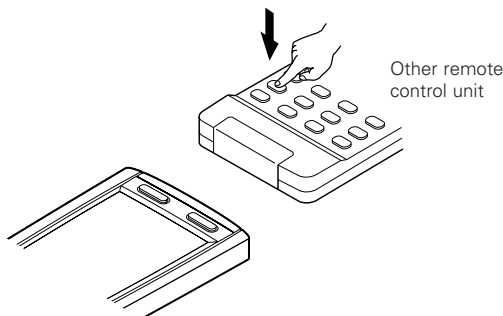

- 6** "OK" appears on the Remote control unit's display and learning is completed.

- Other keys can be "learned" by repeating steps 5 to 6.
- "FAIL" appears on the Remote control unit's display, repeating steps 4 to 6.

- 7** The mode can be switched by pressing a mode selector button. The "Buttons that allow learning" display reappears and the learning standby mode is set.

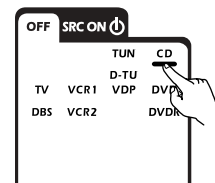

- 8** To cancel the learning mode, press the power ON button and the OFF button simultaneously again.



System call

The accessories Remote control unit is equipped with "system call" function allowing a series of remote control signals to be transmitted by pressing a single button.

This function can be used for example to turn on the amplifier's power, select the input source, turn on the monitor TV's power, turn on the source component's power and set the source to the play mode, all at the touch of a single button.

(1) System call buttons

Up to 12 signals each can be stored at the "CALL1" ~ "CALL6" buttons.

The System Call function can be used in the AMP, ZONE2, ZONE3 and ZONE4 modes.

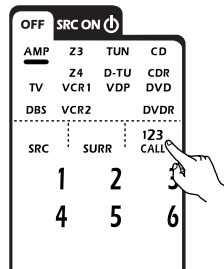

(2) Storing system call signals

- 1 Press the power ON button and the OFF button at the same time.



- 2 Press the "3" button to select system call setting.

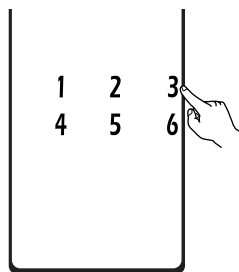

- 3 Press the Mode button for the component you want to register at the system call button, then press the ENTER button.

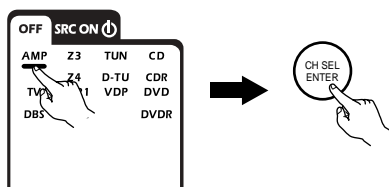

- 4 Press the button you want to register.

- 5 The mode can be switched by pressing a mode button.

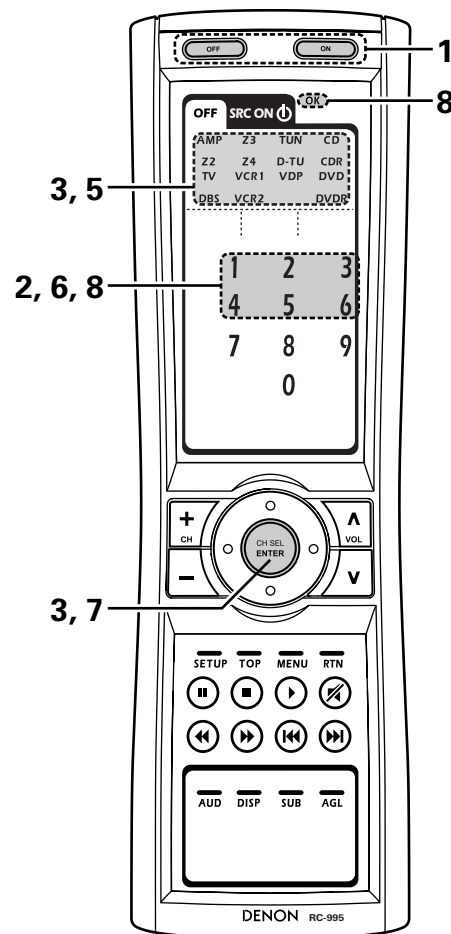
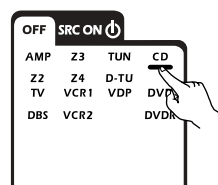

- 6 Repeat steps 4 and 5 to register the desired buttons. Up to 12 signals each can be stored at the CALL1~CALL6.

- 7 Press the ENTER button after the button registration is completed. There will be a changeover to the System Call registration screen.

- 8 Press buttons from "CALL 1" to "CALL 6" to register the System Call.

- "OK" is displayed and the set returns to the normal operating mode.

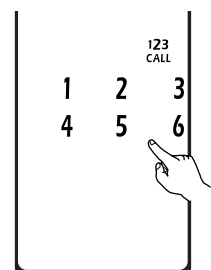

NOTES:

- The remote control signals of the buttons pressed while registering the system call signals are emitted, so be careful not to operate the components accidentally (cover the remote sensors, for example).
- If you exceed the number of signals that can be registered, there will be a changeover to the System Call registration screen.

(3) Using the system call function

- 1** Press the button at which the system call signals have been stored.
- The stored signals are transmitted successively.

Punch Through

(1) Punch through button

Buttons used in the CD, CDR, DVD, DVDR, VDP, VCR1 and VCR2 modes can be assigned to the buttons which are not normally used in the AMP, ZONE2, ZONE3, ZONE4, TV and DBS modes. For example, when the CD mode is set to the punch through mode in the AMP mode, the CD mode's PLAY, STOP, MANUAL SEARCH, AUTO SEARCH and PAUSE buttons' signals are sent in the AMP mode.

(2) Making the punch through setting

- 1** Press the power ON button and the OFF button at the same time.



- 2** Press the "4" button to select punch through setting.

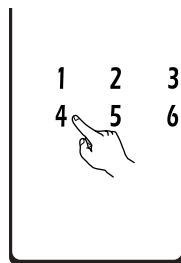

- 3** Press the mode button for the component you want to make the punch through setting, then press the ENTER button.

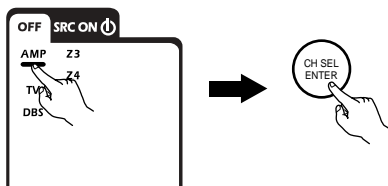

- 4** Press the mode button for the component you want to punch through, then press the ENTER button.
- The punch through is set and the set returns to the normal operating mode.

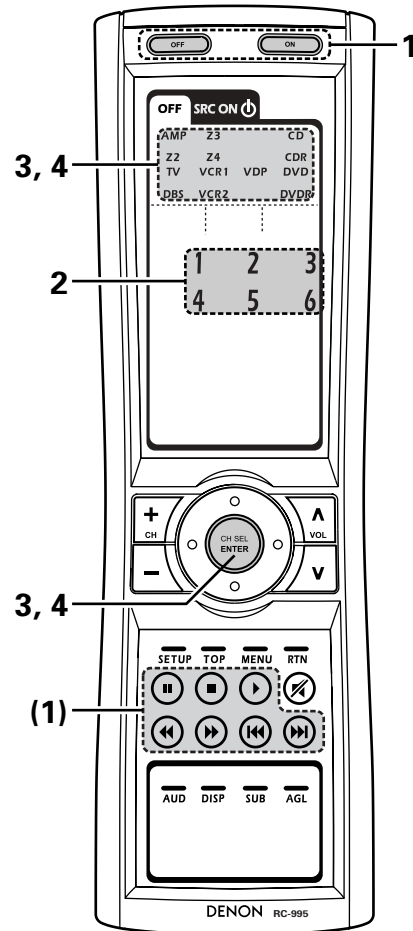
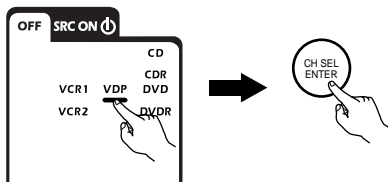

Setting the back light's lighting time

- 1** Press the power ON button and the OFF button at the same time.

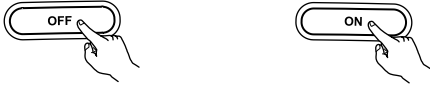

- 2** Press the "5" button to select Light setup.

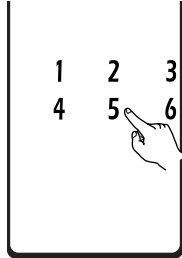

- 3** Press the button you want to adjust the lighting time (5 sec ~ 20 sec).

- Lighting time
 - 1: 5 sec
 - 2: 10 sec (factory default)
 - 3: 15 sec
 - 4: 20 sec

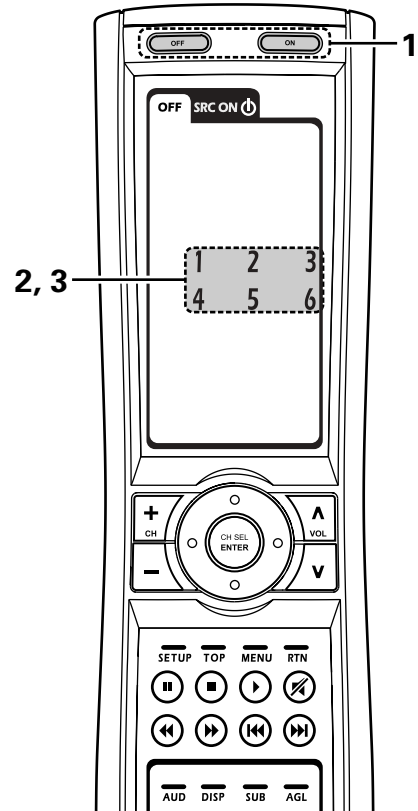
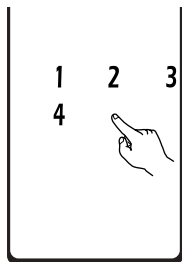

Setting the brightness

The brightness of the display can be adjusted in 3 levels.

- For 1 brightness step increase, hold the ENTER button and press the CH+ (channel up) button.
- For 1 brightness step decrease, hold the ENTER button and press the CH- (channel down) button.

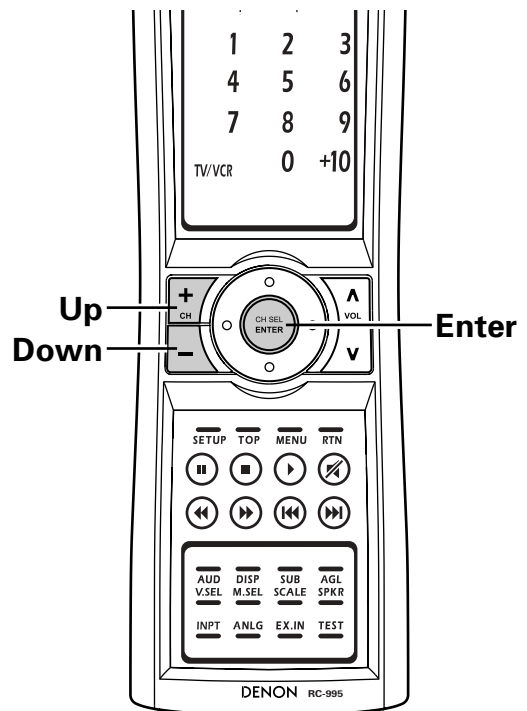
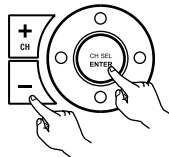

Resetting

(1) Resetting the preset memory

1 Press the power ON button and the OFF button at the same time.



2 Press the "6" button to select Resetting.

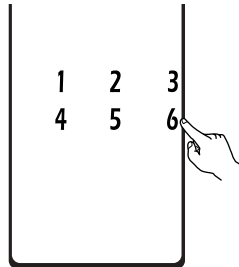

3 Press the "1" button to resetting the preset memory.

• Resetting List

- 1: Resetting the preset memory
- 2: Resetting the "Learned" buttons
- 3: Resetting the system call
- 4: Resetting the punch through setting
- +10: All reset function (factory default)

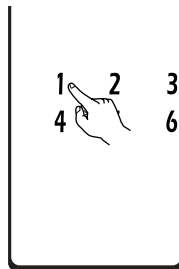

4 The mode buttons that were set in preset memory will all light.

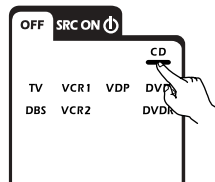

5 Press the mode button you want to resetting, then press the ENTER button.

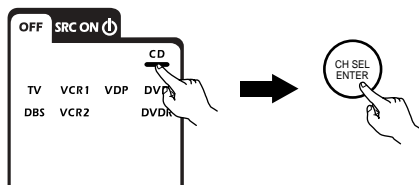

The set returns to the normal operating mode.

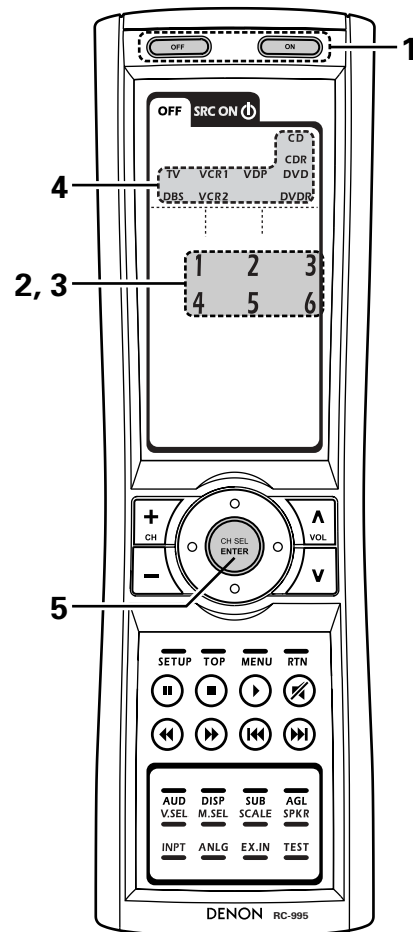

(2) Resetting "learned" buttons

- 1** Press the power ON button and the OFF button at the same time.

 - 2** Press the "6" button to select resetting.

 - 3** Press the "2" button to resetting the "learned" buttons.

 - 4** The mode buttons will all light.

 - 5** Press the mode button you want to resetting, then press the ENTER button.
The set returns to the normal operating mode.
-

(3) Resetting the system call buttons

- 1** Press the power ON button and the OFF button at the same time.

 - 2** Press the "6" button to select resetting.

 - 3** Press the "3" button to resetting the system call buttons.

 - 4** All buttons of System Call will light.

 - 5** Press the button you want to resetting, then press the ENTER button.
The set returns to the normal operating mode.
-

(4) Resetting the punch through setting

- 1** Press the power ON button and the OFF button at the same time.

 - 2** Press the "6" button to select resetting.

 - 3** Press the "4" button to resetting the "punch through" setting.

 - 4** All punched through mode buttons will light.

 - 5** Press the mode button you want to resetting, then press the ENTER button.
The set returns to the normal operating mode.
-

(5) All reset function

- 1** Press the power ON button and the OFF button at the same time.

 - 2** Press the "6" button to select resetting.

 - 3** Press the "+10" button to clear the entire system memory, which will restore the Remote control unit to the factory default settings. This operation will take approximately 20 seconds. Only use this if you wish to clear all customized settings and memories and restore the unit to its out-of-the-box factory default settings.
-

9 OPERATION

Operating the Remote control unit

1 Select "AMP" using the AMP/Z2 button.

2 [SOURCE MENU]
• Operate the source.

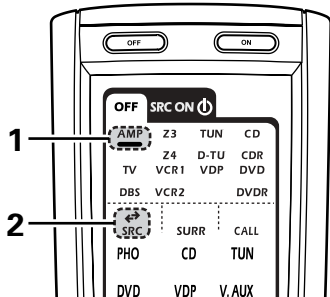

3 [SURROUND MENU]
• Operate the surround mode.

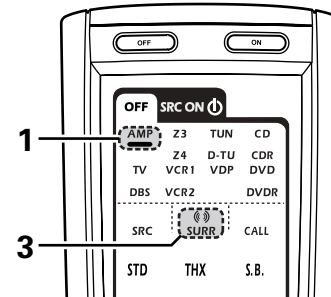

Before operating

1 Refer to "CONNECTIONS" (pages 9 to 21) and check that all connections are correct.

2 Press the POWER switch (button).



- **ON**
The power turns on and the power indicator lights.
Set the power switch to this position to turn the power on and off from the included Remote control unit.
- **OFF**
The power turns off and indicator is off.
In this position, the power cannot be turned on and off from the Remote control unit.

3 Turn on the power
Press the POWER ON/STANDBY switch (button).

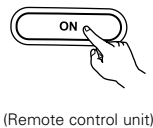

- When pressed, the power turns on and the display lights. The sound is muted for several seconds, after which the unit operates normally.
- When pressed again, the power turns off, the standby mode is set and the display turns off.
- Whenever the ON/STANDBY button is in the STANDBY state, the apparatus is still connected to the AC line voltage. Please be sure to turn off the power switch or unplug the cord when you leave home for, say, a vacation.

4 Select "AMP" using the AMP/Z2 button.
(only when operating with the Remote control unit)

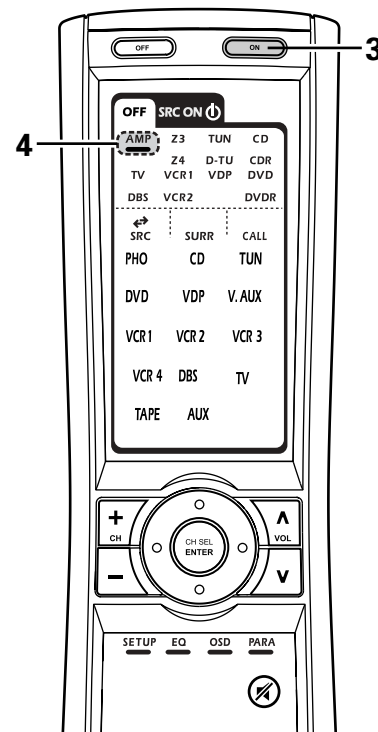
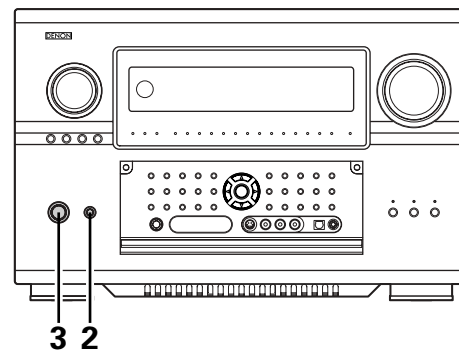
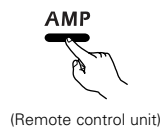

Playing the input source

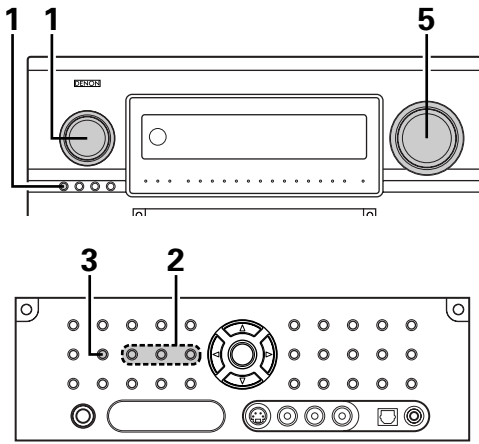

1 Select the input source to be played.

Example: CD

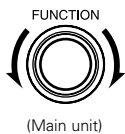

※ When the input source is selected the input indicator lights.

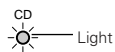

※ To select the input source when ZONE2 SELECT, ZONE3/4/REC SELECT or TUNING PRESET is selected, press the SOURCE button then operate the input function selector.

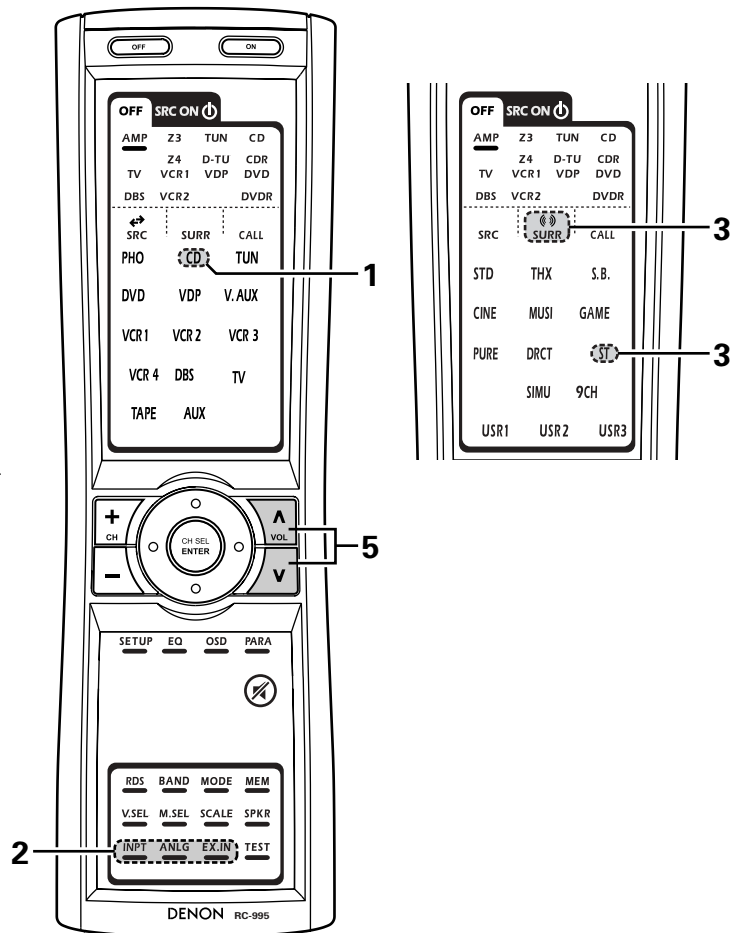

2 Select the input mode.

- Selecting the analog mode
Press the ANALOG button to switch to the analog input.

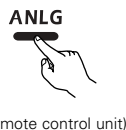

- Selecting the external input (EXT. IN) mode
Press the EXT. IN (on the EXT. IN button on the Remote control unit) to switch the external input.

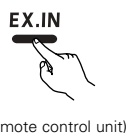

- Selecting the AUTO, PCM and DTS modes
The mode switches as shown below each time the INPUT MODE button is pressed.

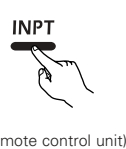

Input mode selection function

Different input modes can be selected for the different input sources. The selected input modes for the separate input sources are stored in the memory.

① AUTO (All auto mode)

In this mode, the types of signals being input to the digital and analog input jacks for the selected input source are detected and the program in the AVR-5805's surround decoder is selected automatically upon playback. This mode can be selected for all input sources other than PHONO and TUNER.

The presence or absence of digital signals is detected, the signals input to the digital input jacks are identified and decoding and playback are performed automatically in DTS, Dolby Digital or PCM (2 channel stereo) format. If no digital signal is being input, the analog input jacks are selected.

Use this mode to play Dolby Digital signals.

② PCM (exclusive PCM signal playback mode)

Decoding and playback are only performed when PCM signals are being input.

Note that noise may be generated when using this mode to play signals other than PCM signals.

③ DTS (exclusive DTS signal playback mode)

Decoding and playback are only performed when DTS signals are being input.

④ ANALOG (exclusive analog audio signal playback mode)

The signals input to the analog input jacks are decoded and played.

⑤ EXT. IN (external decoder input jack selection mode)

The signals being input to the external decoder input jacks are played. (page 128)

Note on playing a source encoded with DTS

- Noise may be generated at the beginning of playback and while searching during DTS playback in the AUTO mode. If so, play in the DTS mode.

3 Select the play mode.
Example: Stereo

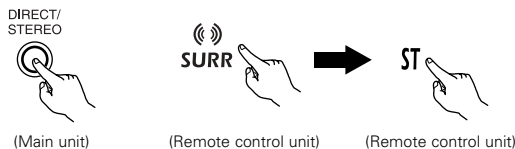

※ The mode switches as shown below each time the DIRECT/STEREO button on the Main unit is pressed.



4 Start playback on the selected component.
 • For operating instructions, refer to the component's manual.

5 Adjust the volume.

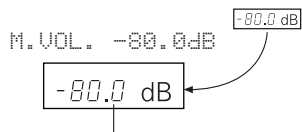
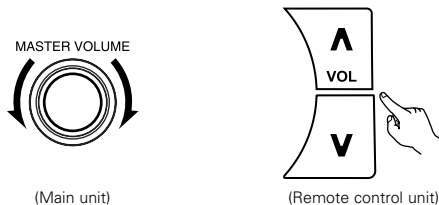

The volume level is displayed on the master volume level display.

※ The volume can be adjusted within the range of -80 to +18 dB, in steps of 0.5 dB. However, when the channel level is set as described on pages 51, 52 or 134, 135, if the volume for any channel is set at +0.5 dB or greater, the volume cannot be adjusted up to 18 dB. (In this case the maximum volume adjustment range is "18 dB — (Maximum value of channel level)".)

Input mode when playing DTS sources

- Noise will be output if DTS-compatible CDs or LDs are played in the "ANALOG" or "PCM" mode.
 When playing DTS-compatible sources, be sure to connect the source component to the digital input jacks (OPTICAL/COAXIAL) and set the input mode to "DTS".

Input mode display

- In the AUTO mode



- In the DIGITAL PCM mode



- In the DIGITAL DTS mode



- In the ANALOG mode



- In the EXT.IN mode



Depending on the input signal.

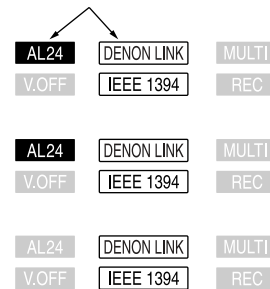

Input signal display

- DOLBY DIGITAL



- DTS



- PCM

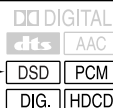

Depending on the input signal.

- The [DSD] indicator lights when the DENON LINK have been connected and the DSD signals have been inputted. (See page 18)

Depending on the input signal.

- The [HDCD] indicator lights when digital signals are being input with a player that supports HDCD playback.

- The [DIG.] indicator lights when digital signals are being input properly. If the [DIG.] indicator does not light, check whether the digital input component setup (pages 58, 59) and connections are correct and whether the component's power is turned on.
- AL24 processing is activated when PCM signals are played while the surround mode is set to PURE DIRECT, DIRECT, STEREO, MULTI CH DIRECT or MULTI CH IN.
- Advanced AL24 processing is activated when PCM (2-channel) signals are played while the surround mode is set to PURE DIRECT or DIRECT.

NOTE:

- The [DIG.] indicator will light when playing CD-ROMs containing data other than audio signals, but no sound will be heard.

Playback using the external input (EXT. IN) jacks

- 1** Set the external input (EXT. IN) mode.
Press the EXT. IN button (on the Remote control unit) to switch the external input.

The playback switches as shown below each time the button is pressed.

EXT. IN-1 ↔ EXT. IN-2

EXT. IN



(Main unit)

EX.IN



(Remote control unit)

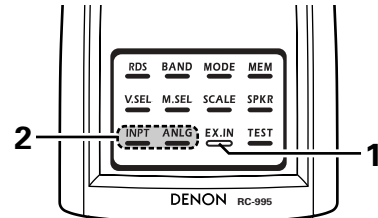
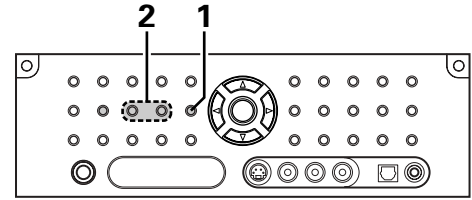

- **EXT. IN-1**
Once this is selected, the input signals connected to the FRONT-L, FRONT-R, CENTER, SURR.-L A/B (surround left A/B), SURR.-R A/B (surround right A/B) SB-L (surround back left) and SB-R (surround back right) channels of the EXT. IN jacks are output directly to the front (left and right), center, surround A/B (left and right A/B) and surround back (left and right) speaker systems as well as the pre-out jacks.
In addition, the signal input to the SW (subwoofer) jack is output to the PRE OUT SW (subwoofer) jack.
- **EXT. IN-2**
Once this is selected, the input signals connected to the FRONT-L, FRONT-R, CENTER, SURR.-L (surround left) and SURR.-R (surround right) channels of the EXT. IN jacks are output directly to the front (left and right), center and surround (left and right) speaker systems as well as the pre-out jacks.
In addition, the signal input to the SW (subwoofer) jack is output to the PRE OUT SW (subwoofer) jack.

Playback using the external input jacks (EXT.IN-1 and EXT.IN-2)

- ① When the "ANALOG" mode is selected at "3-2. EXT.IN Setup" at the System Setup:
The surround playback mode button does not function.
- ② When the "DSP" mode is selected at "3-2. EXT.IN Setup" at the System Setup: The surround playback mode button functions.

Press the SURROUND PARAMETER button to display the surround parameters screen.
Select the parameter (Cursor up/down) and select the setting value (Cursor left/right).
Press the SURROUND PARAMETER button to complete.

- **Input CH parameter**
2 CH: Select when the input source being played is a 2-channel source.
MULTI CH: Select when the input source being played is a multi-channel source.

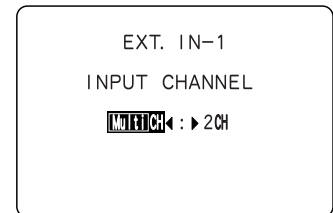
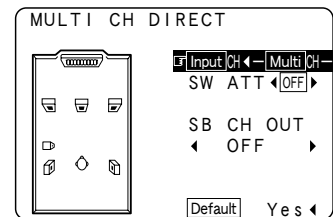

2

INPUT MODE



(Main unit)

ANALOG



INPT



(Remote control unit)

ANLG



Canceling the external input mode

To cancel the external input (EXT. IN) setting, press the INPUT MODE or ANALOG button to switch to the desired input mode.

- When the input mode is set to EXT. IN (1 or 2), playback in the DIRECT, STEREO, DOLBY/DTS SURROUND, HOME THX CINEMA, WIDE SCREEN, 9CH STEREO and DSP SIMULATION modes is only possible when DSP MODE is selected for Ext.In Setup at System Setup.
- When the DIRECT button is pressed while the input channel parameter is set to "MULTI CH", the MULTI CH DIRECT mode is set. When the STANDARD button is pressed, the MULTI CH IN mode is set. (See page 186)

NOTES:

- In play modes other than the external input mode, the signals connected to these jacks cannot be played. In addition, signals cannot be output from channels not connected to the input jacks.
- The external input mode can be set for any input source. To watch video while listening to sound, select the input source to which the video signal is connected, then set this mode.

■ Playback using the DENON LINK connector

Digital transfer and multi-channel playback of DVD audio discs and other multi-channel sources is possible by connecting the AVR-5805 to a Denon DVD player equipped with a DENON Link connector using the connection cable included with the DVD player.

With discs on which special copyright protection measures have been taken, however, the digital signals may not be output from the DVD player. In this case, connect the DVD player's analog multi-channel output to the AVR-5805's EXT. IN-1 or EXT. IN-2 terminals for playback.

Also refer to your DVD player's operating instructions.

Playing audio sources (CDs and DVDs)

The AVR-5805 is equipped with three 2-channel playback modes exclusively for music. Select the mode to suit your tastes.

1 PURE DIRECT mode

In this mode, the music is played with an extremely high level of sound quality.

When this mode is set, all the video-related circuits are turned off so that music signals can be reproduced with high quality. When an analog mode is selected, the digital processing circuitry is also turned off to achieve analog sound with even higher purity. (See NOTES page 129)

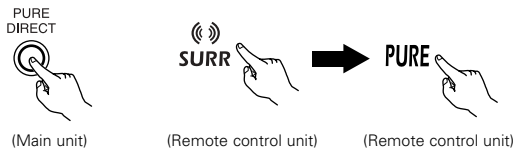

2 DIRECT mode

Use this mode to achieve good quality 2-channel sound while watching images. In this mode, the audio signals bypass such circuits as the tone circuit and are transmitted directly, resulting in good quality sound.

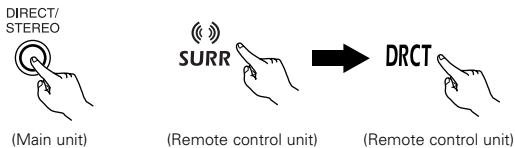

※ The mode switches as shown below each time the DIRECT/STEREO button on the Main unit is pressed.

DIRECT ←→ STEREO

3 STEREO mode

Use this mode to adjust the tone and achieve the desired sound while watching images.

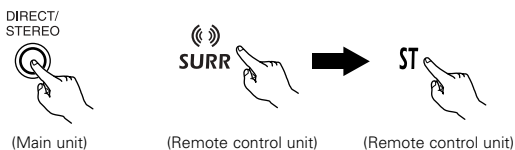

4 VIDEO ON/OFF button

When no video signals of a DVD, etc., are connected to the AVR-5805 and the DVD, etc., are connected directly to a TV, etc., the unneeded video circuitry can be turned off by selecting the "VIDEO OFF" setting.

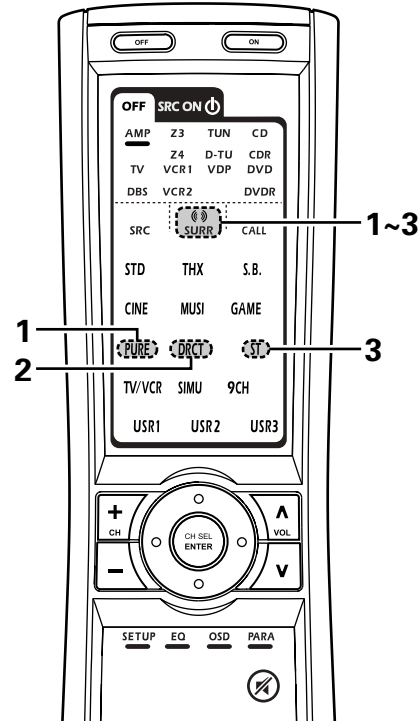
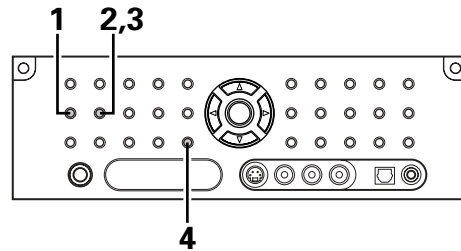

NOTES:

- The system setup function cannot be used when the PURE DIRECT mode is set. To use the system setup function, cancel the PURE DIRECT mode.
- The Zone2 and Zone3 video outputs are not outputted in the VIDEO OFF mode.
- If the HDMI input terminal is selected, video outputs are outputted in the PURE DIRECT mode.
- The channel level and surround parameters in the PURE DIRECT mode are the same as in the DIRECT mode.

After starting playback

[1] Setting the Room EQ

- 1** The Room EQ switches as follows each time the ROOM EQ button is pressed.



(Main unit)



(Remote control unit)



- ※ See pages 30, 40 for descriptions of the correction curves for the "Room EQ" function.
- ※ "MultEQ XT" indicator lights green when "Audyssey", "Front" or "Flat" is selected. If you change the "Speaker Configuration", "Delay Time", "Channel Level" or "Crossover Frequency" settings are changed after performing the "Auto Setup" procedure, the "MultEQ XT" indicator lights red.

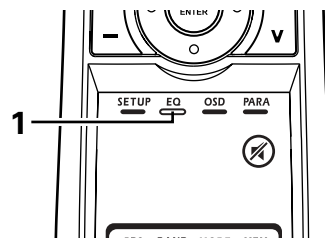
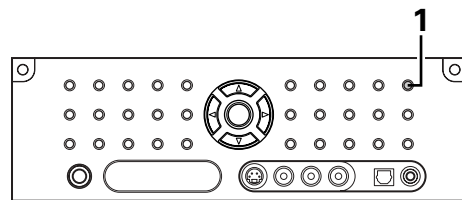

[2] Listening over headphone

- 1** Plug the headphone plug into the jack.

- ※ Connect the headphone to the PHONES jack. The pre-out output (including the speaker output) is automatically turned off when headphones are connected.

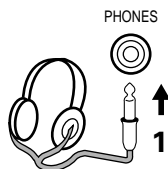

NOTE:

- To prevent hearing loss, be careful not to raise the volume level excessively when using headphones.

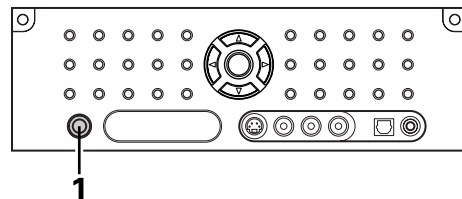

[3] Turning the sound off temporarily (MUTING)

- 1** Use this to mute the audio output temporarily. Press the MUTING button.



(Remote control unit)

- ※ Muting level is the same level as set with "7-3. Volume Control" (pages 106, 107).
- ※ Cancelling MUTING mode. Press the MUTING button again, or press the volume up or down buttons on the Remote control, or adjust the volume up or down via the front panel volume control knob.

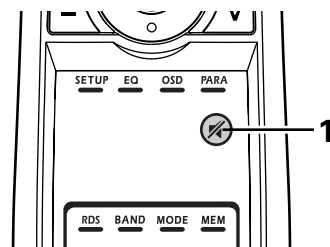

[4] Combining the currently playing sound with the desired image (VIDEO SELECT)

- 1** Press the Remote control unit or Main unit's VIDEO SELECT button until the desired image appears. The video source selected with the video select function is stored in the memory for the different input sources.



(Main unit)



(Remote control unit)

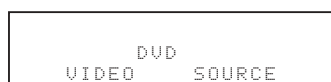

- ※ Cancelling simulcast playback.
 - Select "SOURCE" using the VIDEO SELECT button.

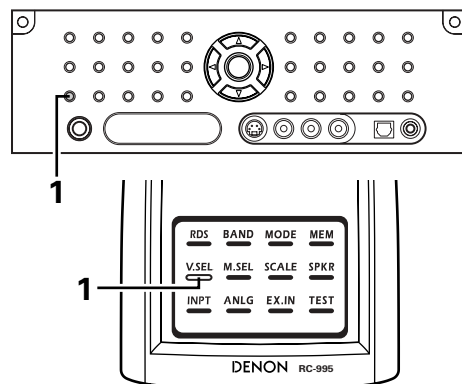

[5] Checking the currently playing program source, etc.

- 1
 - ① On screen display
 Each time an operation is performed, a description of that operation appears on the display connected to AVR-5805's VIDEO MONITOR OUT jack. Also, the unit's operating status can be checked during playback by pressing the Remote control unit's ON SCREEN button.
 Such information as the position of the input selector and the surround parameter settings is output in sequence.
 - ② Front panel display
 Descriptions of the unit's operations are also displayed on the front panel display. In addition, the display can be switched to check the unit's operating status while playing a source by pressing the STATUS button.
 - ③ Using the dimmer function
 Use this to change the brightness of the display.
 The display brightness changes in four steps (bright, medium, dim and off) by pressing the Main unit's DIMMER button repeatedly.

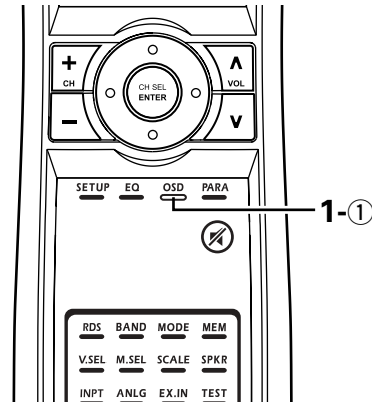
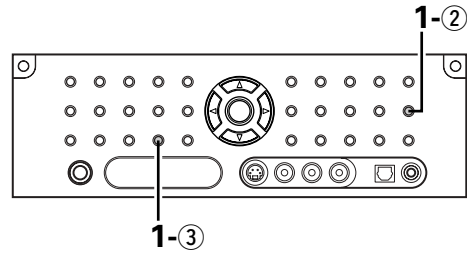
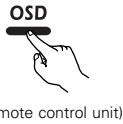

[6] Switching the surround speakers

- 1 The surround speakers switch as shown below each time the SPEAKER button is pressed.

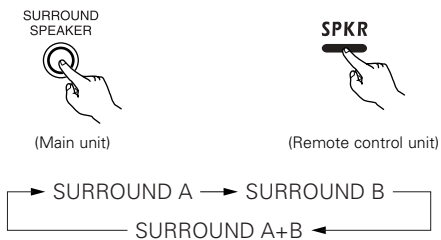

※ This operation is possible when the setting for using both surround speakers A and B is made at "2-1. Speaker Configuration" (pages 46, 47).

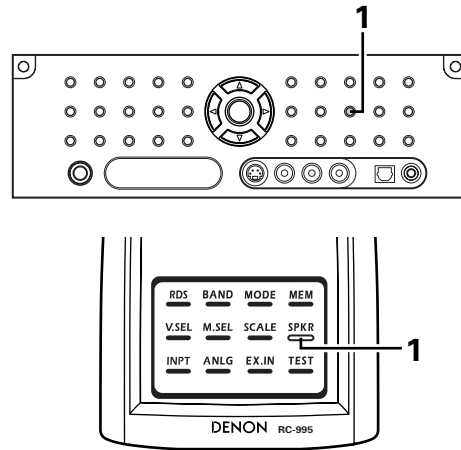

[7] Switching between HDMI and DVI monitor output

- 1 The monitor out terminal switch as shown below each time the MONITOR SELECT button is pressed.

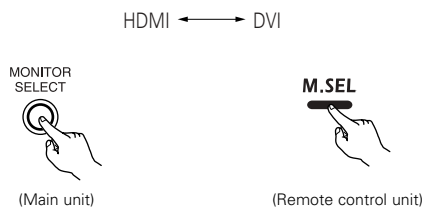

※ This operation is possible when the HDMI or DVI input terminal is assigned to be input source at "4-5. HDMI / DVI In Assign" (pages 75, 76).

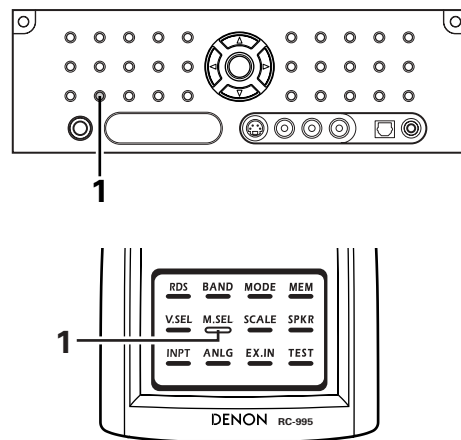

[8] Selection of resolution setting (SCALE)

- 1** The resolution switches as follows each time the SCALE button is pressed.

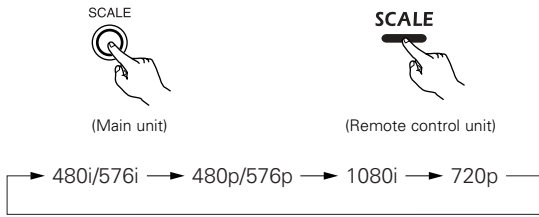

※ See page 73 for descriptions of the different resolution settings.

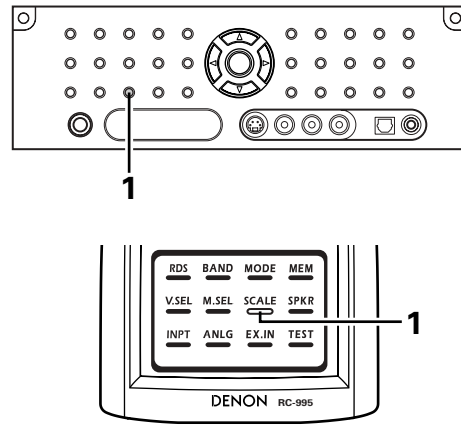

Multi-source recording/playback

[1] Playing one source while recording another (REC OUT mode)

- 1** Press the ZONE3/4/REC SELECT button until "ZONE3 SOURCE" appears on the display.



- 2** With "ZONE3 SOURCE" displayed, turn the FUNCTION knob until "RECOUT SOURCE" appears on the display. With "RECOUT SOURCE" displayed, turn the FUNCTION knob to select the source you wish to record.
- The "REC" indicator lights.

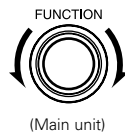

- 3** Set the recording mode.
- For operating instructions, refer to the manual of the component on which you want to record.

- 4** To cancel, turn the function knob and select "SOURCE".

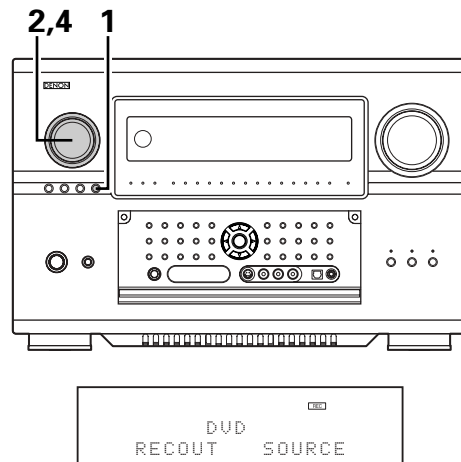
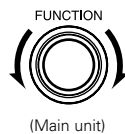

NOTES:

- Recording sources other than digital inputs selected in the REC OUT mode are also output to the Zone3 audio/video output jacks.
- When the REC OUT mode is selected, the Zone3 button on the Remote control unit cannot be operated.

[2] Recording Dolby Digital and DTS multichannel sources

- With this set it is possible to record Dolby Digital and DTS multichannel signals converted into 2-channel analog signals.
- The recording signals are output to the ZONE3 OUT, TAPE and VCR output terminals.
- Down-mixed analog signals converted into digital signals are output from the OPTICAL 3, 4 and 5 digital output terminals at this time.

1 Press the ZONE3/4/REC SELECT button until "RECOU *****" (ZONE3 *****) appears on the display. Then select "RECOU SOURCE".

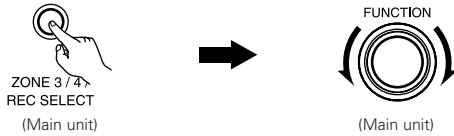

2 Set the input mode according to the source to be played.

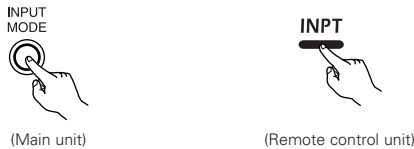

3 Set the surround mode by pressing the DIRECT or STEREO button.

- The multichannel digital signals are down-mixed and output to the TAPE and VCR output terminals.

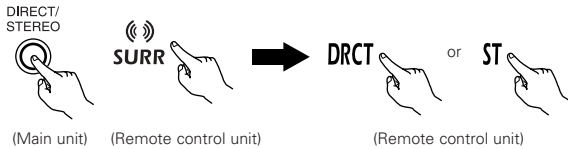

4 Set the recording mode.

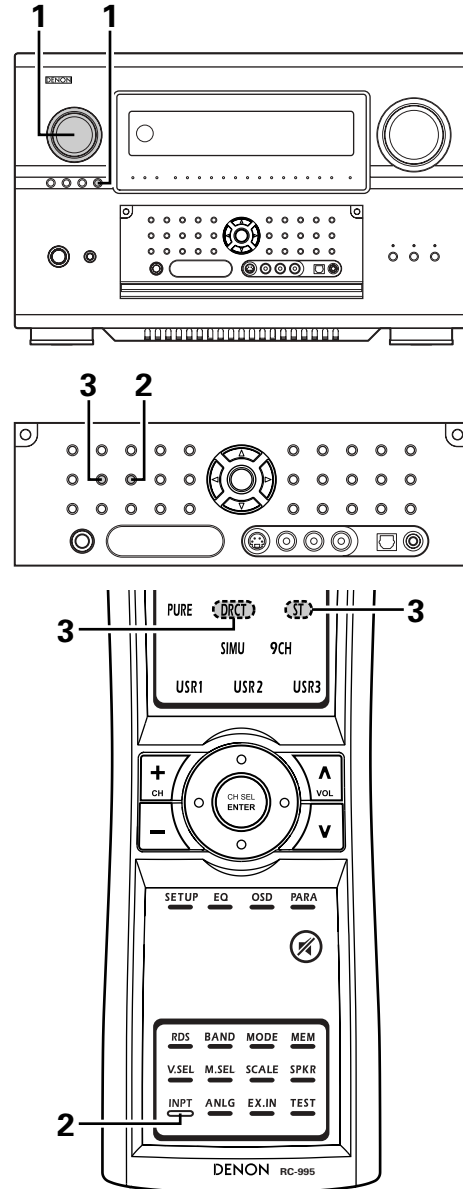

[3] Dolby Headphone recording

- When RECOU mode is set to "source", with the AVR-5805 it is possible to output signals encoded in the Dolby Headphone mode from the recording output terminal and record them on a separate recorder.

1 The Dolby Headphone play mode is set when headphones are connected to the PHONES jack during playback in the DOLBY/DTS surround mode.

2 When this is done, signals encoded in the Dolby Headphone mode are automatically output from the recording output terminals (analog and digital) and can be recorded.

3 Select the parameters and set the desired mode, then record. (Refer to the 10 SURROUND "Dolby Headphone" pages 145, 146.)

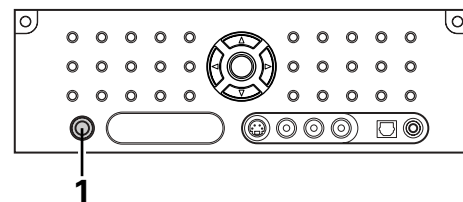

NOTE:
Do not disconnect the headphones during recording.

10 SURROUND

Adjustment steps that need to be performed prior to surround sound playback

※ If the Auto Setup procedure has not been performed or the channel level has not been adjusted at the System Setup Menu, the settings below cannot be made.

[1] Test Tone

- Before playing with the surround function, be sure to use the test tones to adjust the playback level from the different speakers. This adjustment can be performed with the system setup (pages 51, 52) or from the Remote control unit, as described below.
- Adjusting with the Remote control unit using the test tones is only possible in the "Auto" mode and only effective in the STANDARD (DOLBY/DTS SURROUND) modes. The adjusted levels for the different modes are automatically stored in the memory.

1  Press the TEST TONE button.
(Remote control unit)

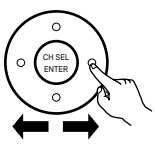
2  Test tones are output from the different speakers. Use the Cursor left and right button to adjust the channel level so that the volume of the test tones is the same for all the speakers.
(Remote control unit)

3  After completing the adjustment, press the TEST TONE button again.
(Remote control unit)

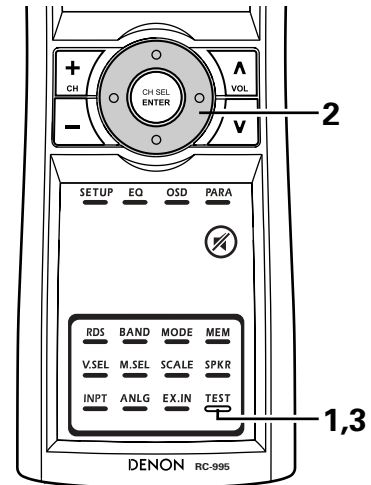

[2] Channel Level

- After adjusting using the test tones, adjust the channel levels either according to the playback sources or to suit your tastes, as described below.

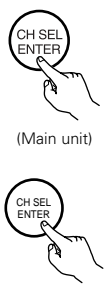
1  Press the ENTER button on the Main unit or Remote control unit. The screen below appears.
(Main unit)
(Remote control unit)

Channel Vol.			
FL	◀ 0.0dB	SR A	0.0dB
C	0.0dB	SR B	0.0dB
FR	0.0dB	SBR	0.0dB
SW	0.0dB	SBL	0.0dB
		SL B	0.0dB
		SL A	0.0dB
		Fader	
		FRONT	◀: ▶REAR

※ Channels which is not used are not displayed.

- 2** Select the speaker level you want to adjust.
- When pressing the ENTER button, the channel switches as shown below each time the ENTER button is pressed.

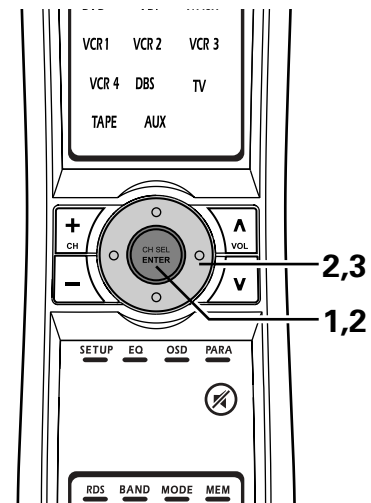
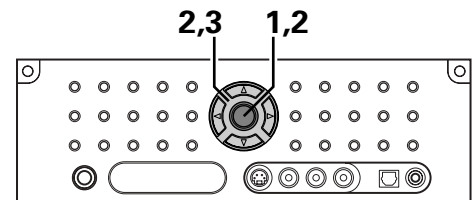
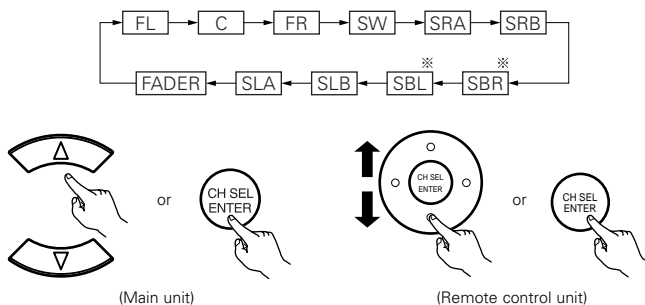

Playing modes for different sources

The AVR-5805 is equipped with many surround modes. We recommend using the surround modes as described below in order to achieve the maximum effect for the specific signal source.

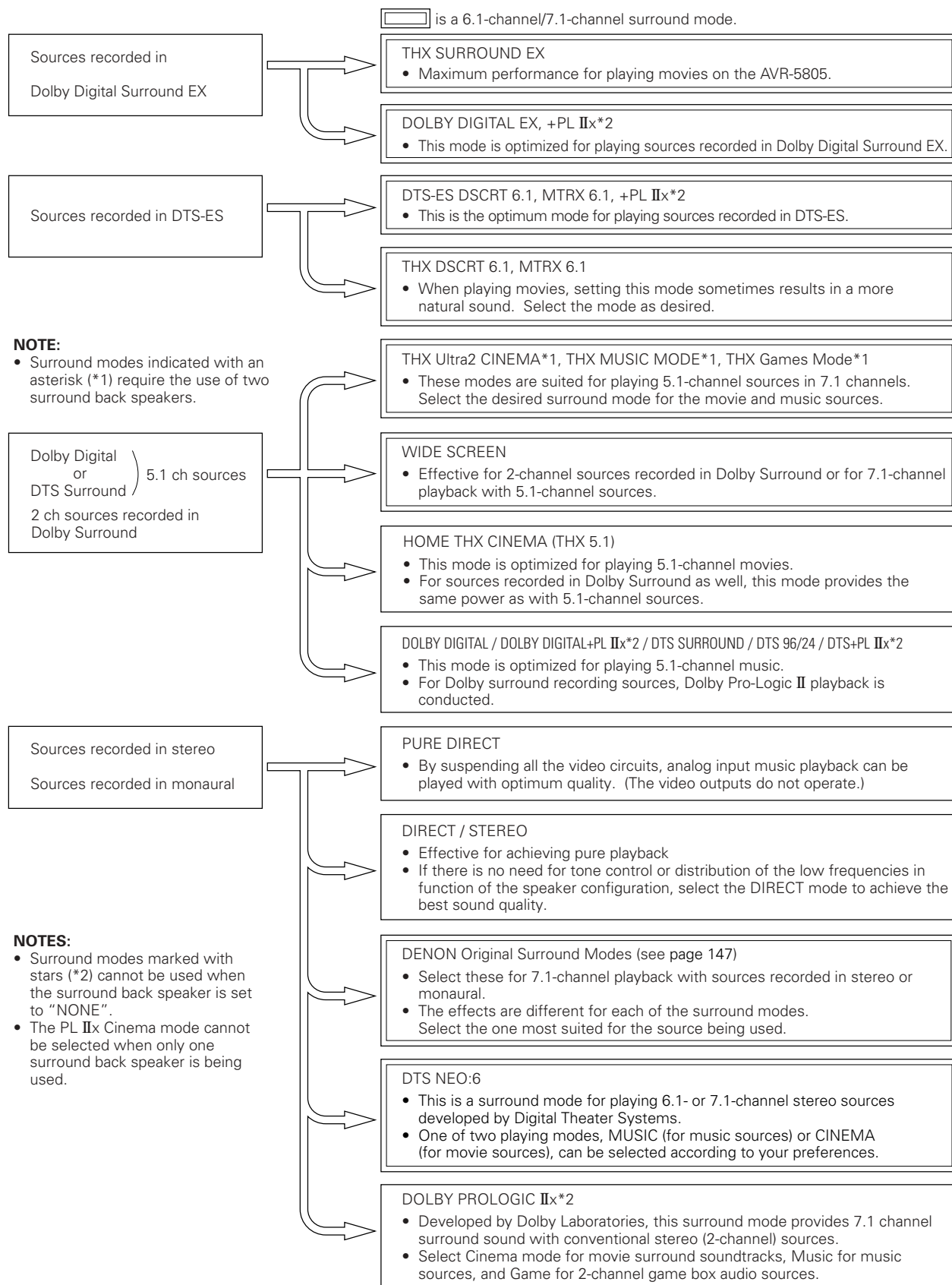

• Though we recommend selecting the surround mode as described above, other surround modes can also be selected.

THX Surround EX / Home THX Cinema mode

When the HOME THX CINEMA button is pressed, the surround mode is set as follows according to the signal that is played:

- ① THX Surround EX (THX Ultra2 Cinema)
- ② Home THX CINEMA
- ③ THX 5.1
- ④ THX DSCRT 6.1, THX MTRX 6.1

When the HOME THX CINEMA mode is set when a DVD is played, check the DVD player's digital output setting and change the setting to one for which Dolby Digital and DTS bit stream signals can be output ("bit stream", for example).

[1] Playing sources recorded in Dolby Surround in the Home THX Cinema surround mode

1 ① Select the input source.



② Set the input mode to "AUTO".



2 Select the Home THX Cinema mode.

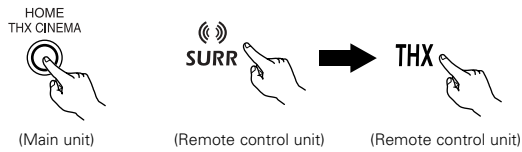

3 Play a program source with the [DOLBY SURROUND] mark.
 • For operating instructions, refer to the manuals of the respective components.

4 Adjust volume.

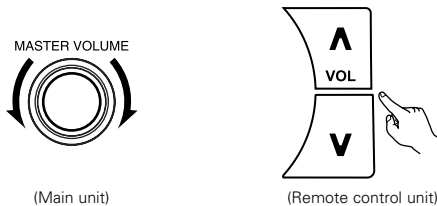

5 Display the Surround Parameter Menu and set the parameters according to the source.

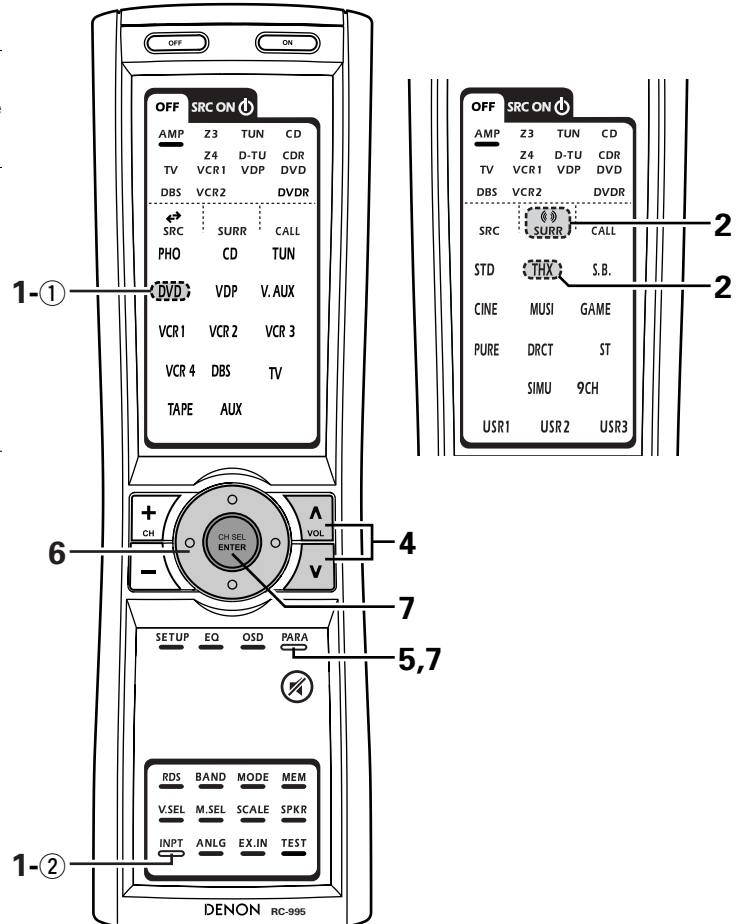
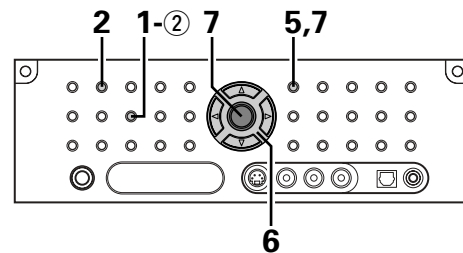
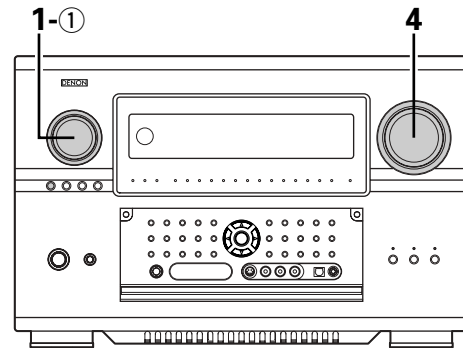
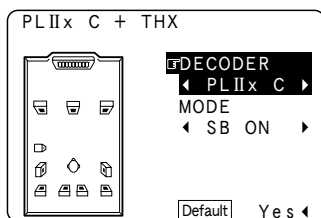

6

① Select the parameter.

② Select the setting.

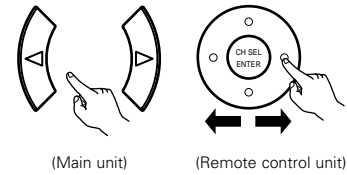
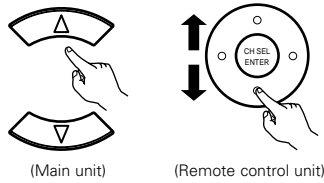

7

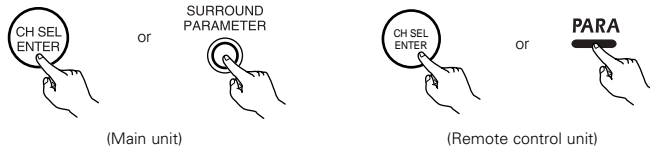

Press the ENTER or SURROUND PARAMETER button to complete the setting.

Surround parameters ①

DECODER:

Select the decoder to be used when playing 2-channel sources in the Home THX Cinema mode.

PL IIx C...The signals are decoded in the Dolby Pro Logic IIx Cinema mode before undergoing THX processing.

PL II C.....The signals are decoded in the Dolby Pro Logic II Cinema mode before undergoing THX processing.

PL.....The signals are decoded in the Dolby Pro Logic mode before undergoing THX processing.

NEO:6 C...The signals are decoded in the NEO:6 Cinema mode before undergoing THX processing.

MODE/SB CH OUT:

Select the surround back channel playback method or mode.

ON.....This is the recommended play mode for using the surround back channel when DTS NEO:6 is selected.

OFF.....This is the recommended play mode when Dolby Pro Logic II is selected. The surround back channel is not played.

Checking the input signal

The input signal can be checked by pressing the Remote control unit's ON SCREEN button. (See page 131)

OSD



SIGNAL: Displays the type of signal (DTS, DOLBY DIGITAL, PCM, etc.).

fs: Displays the input signal's sampling frequency.

FORMAT: Displays the input signal's number of channels.

"Number of front channels/Number of surround channels/LFE on/off"

"SURROUND" is displayed for 2-channel signal sources recorded in Dolby Surround.

OFFSET: Displays the dialog normalization offset value. (See page 141)

FLAG: Displays the special identification signal recorded in the input signal. (See page 139)

"MATRIX" is displayed when matrix processing is conducted on the surround back channel, "DISCRETE" is displayed when discrete processing is conducted.

Not displayed when no identification signal is recorded.

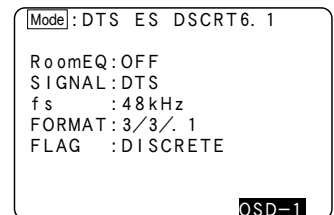
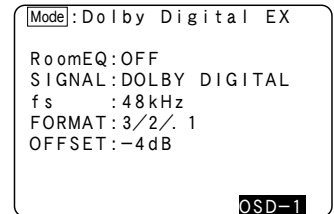

In addition, screen information is displayed in the following order when the ON SCREEN button is pressed repeatedly:

- OSD-1 Audio input signal
- OSD-2 Video information
- OSD-3 Input/output
- OSD-4 Auto surround mode
- OSD-5 USER MODE 1
- OSD-6 USER MODE 2
- OSD-7 USER MODE 3
- OSD-8~14 Tuner preset stations

NOTE:

OSD-4: This is displayed when the auto surround mode is set to "ON" (see page 81) and the input mode is set to "Auto". It is not displayed when the input mode is set to "Analog" or "EXT. IN-1,-2".

OSD-2: This is not displayed on ZONE2 MONITOR OUT when ZONE2 ON SCREEN button is pressed.

[2] To play in the THX Surround EX/Home THX Cinema Surround mode for sources recorded in Dolby Digital or DTS

1 Select the program source.
 Selecting a digital input source
 Perform step 1 under "Dolby Digital mode and DTS Surround" (page 140).

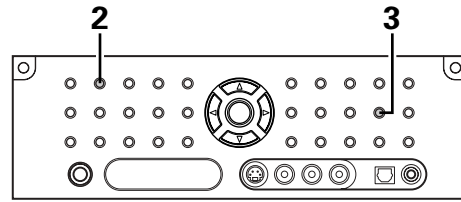

2 Select the Home THX Cinema mode.

 (Main unit) (Remote control unit) (Remote control unit)

3 Play a program source with the mark.
 For operating instructions, refer to the manuals of the respective components.
 The channel status information during playback of Dolby Digital and DTS sources can be checked using the STATUS button on the Main unit.

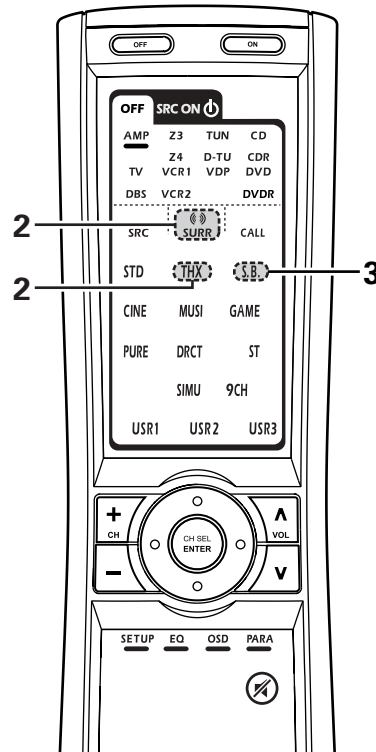

- DIGITAL — Light
 - DTS — Light
 - SBL SB SBR — Light
 - SBL SB SBR — Light
 - SURROUND BACK — Light
- The Dolby Digital indicator lights when playing Dolby Digital sources.
 - The DTS indicator lights when playing DTS sources.
 - Press the SURROUND BACK button. Lights when the Surround Back CH is on.
- (Main unit) (Remote control unit)

Surround parameters ②

For instructions on setting the surround parameters, see page 137.

MODE/SB CH OUT:

Select the surround back channel playback method or mode.

(1) (Multi channel source)

- THX Surround EX.....Dolby Digital signals are played in the THX Surround EX mode.
- Ultra2 Cinema.....The signals are played in the THX Ultra2 Cinema mode.
- Music ModeThe signals are played in the THX Music mode.
- Games Mode.....The signals are played in the THX Games mode.
- NON MTRX.....The same signals as those of the surround channels are output from the surround back channels.
- MTRX ON.....The surround channel signals undergo digital matrix processing and are output from the surround back channels.
- SB OFF (OFF)No signal is played from the surround back channels.
- ES MTRX.....When playing DTS signals, the surround back signals undergo digital matrix processing for playback.
- ES DSCRT.....When a signal identifying the source as a discrete 6.1-channel source is included in the DTS signals, the surround back signals included in the source are played.
- PL IIx CinemaProcessing is performed with the Cinema mode of the PL IIx decoder and the Surround Back channel is reproduced.
- PL IIx MusicProcessing is performed with the Music mode of the PL IIx decoder and the Surround Back channel is reproduced.

(2) (2ch source)

- OFF.....Playback is conducted without using the surround back speaker.
- ON.....Playback is conducted using the surround back speaker.

※ This operation can be performed directly using the SURROUND BACK on the Main unit or Remote control unit.

AFDM (Auto Flag Detect Mode):

- ON.....This function only works with software on which a special identification signal is recorded. This software is scheduled to go on sale in the future.
 This is a function for automatically playing in the 6.1-channel mode using the surround back speakers if the software is recorded in THX Surround EX or DTS-ES or in the normal 5.1-channel mode without using the surround back speakers when the software is not recorded in THX Surround EX or DTS-ES.
- OFF.....Set the "OFF" mode to perform 6.1-channel playback with conventional 5.1-channel sources or sources on which the identification signal described below is not recorded.

Dolby Digital mode (only with digital input) and DTS Surround (only with digital input)

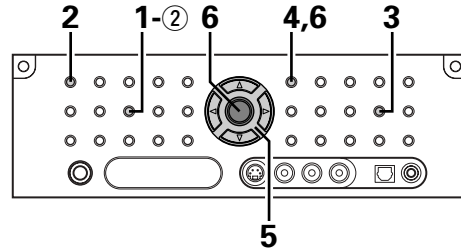
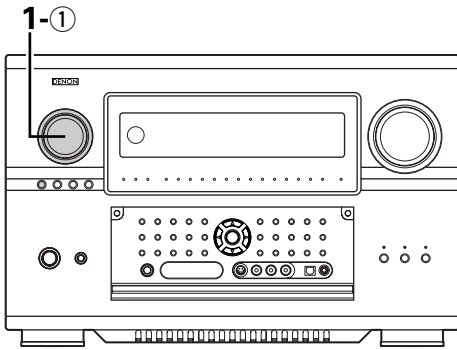

1 Select the input source.

Playback with digital input

- 1 Select an input source set to digital (COAXIAL/OPTICAL) (see pages 58, 59).

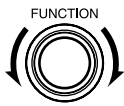

(Main unit)



(Remote control unit)

- 2 Set the input mode to "AUTO".



(Main unit)



(Remote control unit)

2 Select the STANDARD (Dolby/DTS Surround) mode.



(Main unit)



(Remote control unit)



(Remote control unit)

3 Play a program source with the mark.

DIGITAL — Light

- The Dolby Digital indicator lights when playing Dolby Digital sources.

— Light

- The DTS indicator lights when playing DTS sources.

— Light

- Press the SURROUND BACK button. Lights when the Surround Back CH is on.

— Light

SURROUND BACK



(Main unit)



(Remote control unit)

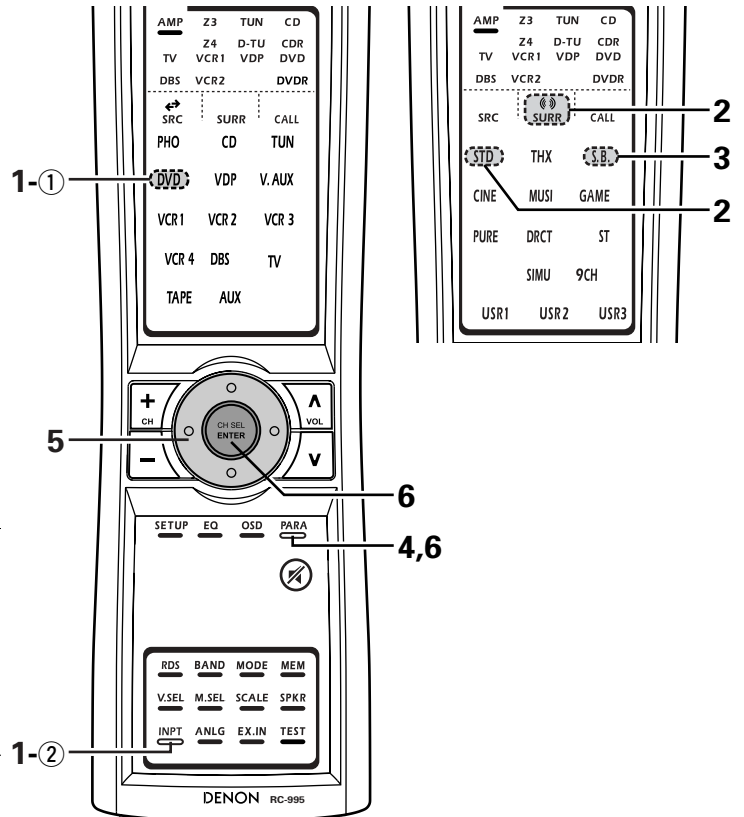

4 Display the Surround Parameter Menu.

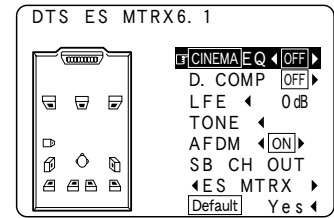
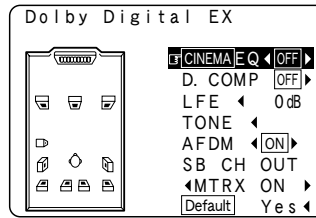
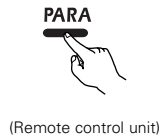

5 ① Select the parameter.

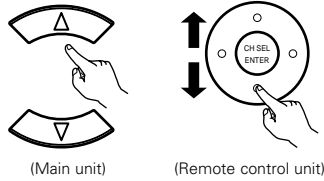

② Select the setting.

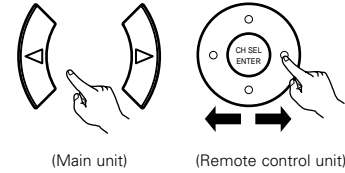

6



Press the ENTER or SURROUND PARAMETER button to complete the setting.

NOTE:

- When "Default" is selected and the Cursor left button is pressed, "CINEMA EQ." and "D.COMP." are automatically turned off, "LFE" is reset, and "Tone" is set to the default value.

Surround parameters ③

CINEMA EQ. (Cinema Equalizer):

The Cinema EQ function gently decreases the level of the extreme high frequencies, compensating for overly-bright sounding motion picture soundtracks. Select this function if the sound from the front speakers is too bright.

This function only works in the Dolby Pro Logic IIx, Dolby Pro Logic, Dolby Digital, DTS Surround, DTS NEO:6 and WIDE SCREEN modes.

D.COMP. (Dynamic Range Compression):

Motion picture soundtracks have tremendous dynamic range (the contrast between very soft and very loud sounds). For listening late at night, or whenever the maximum sound level is lower than usual, the Dynamic Range Compression allows you to hear all of the sounds in the soundtrack (but with reduced dynamic range). (This only works when playing program sources recorded in Dolby Digital or DTS.) Select one of the four parameters ("OFF", "LOW", "MID" (middle) or "HI" (high)). Set to OFF for normal listening.

This parameter is displayed only when playing compatible sources in DTS mode.

LFE (Low Frequency Effect):

This sets the level of the LFE (Low Frequency Effect) sounds included in the source when playing program sources recorded in Dolby Digital or DTS.

Program source and adjustment range:

1. Dolby Digital: -10 dB to 0 dB
2. DTS Surround: -10 dB to 0 dB

※ When DTS encoded movie software is played, it is recommended that the LFE LEVEL be set to 0 dB for correct DTS playback.

※ When DTS encoded music software is played, it is recommended that the LFE LEVEL be set to -10 dB for correct DTS playback.

TONE:

This adjusts the tone control. (See pages 149, 150)

This can be set individually for the separate surround mode other than PURE DIRECT, DIRECT and Home THX Cinema mode.

■ Dialogue Normalization

The dialogue normalization function is activated automatically when playing Dolby Digital program sources.

Dialogue normalization is a basic function of Dolby Digital which automatically normalizes the dialog level (standard level) of the signals which are recorded at different levels for different program sources, such as DVD, DTV and other future formats that will use Dolby Digital. When this function is activated, the following message appears on the Main unit's display:

Display

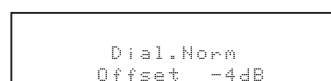

The number indicates the normalization level when the currently playing program is normalized to the standard level.

Dolby Pro Logic IIx (Pro Logic II) mode

To play in the PL IIx mode, set "Sp.Back" at the Speaker Configuration setting to "1Spkr" or "2Spkr".
 To play in the PL IIx mode, set "Surround Back" at the Power Amp Assign setting.

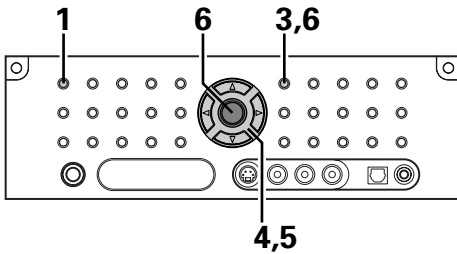

1 Select the Dolby Pro Logic IIx mode using the STANDARD button.

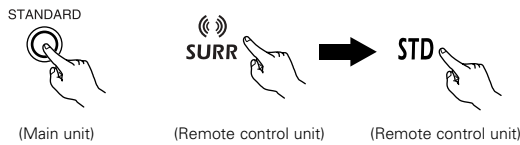

- The mode switches as shown below each time the STANDARD button is pressed.

DOLBY PL IIx ←→ DTS NEO:6

- The Dolby Pro Logic indicator lights.

Light
 DOLBY PRO LOGIC II

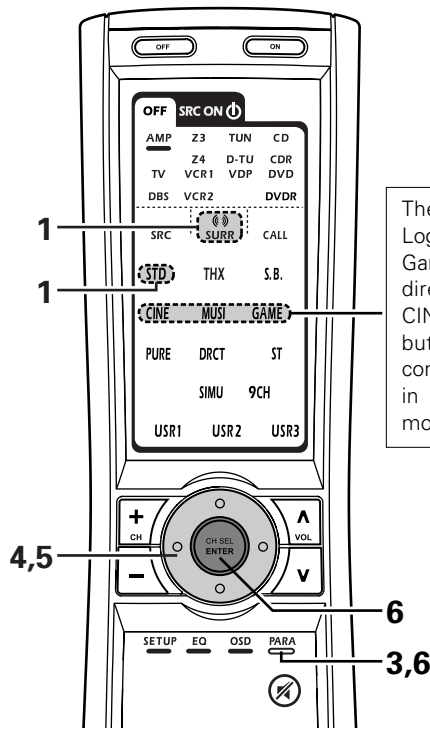

The Dolby Surround Pro Logic IIx Cinema, Music or Game mode can be chosen directly by pressing the CINEMA, MUSIC or GAME button on the Remote control unit during playback in the Dolby Pro Logic IIx mode.

2 Play a program source with the DOLBY SURROUND mark.
 • For operating instructions, refer to the manuals of the respective components.

3 Display the Surround Parameter Menu.

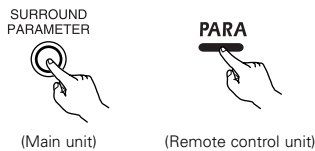

*Surr Parameter
 MODE: ◀ PL IIx C ▶

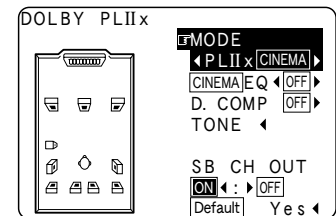

4 Select the play mode.

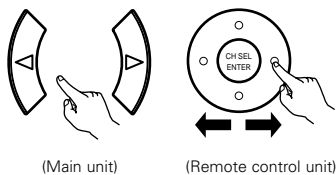

NOTE:

- The PL IIx mode is set when the "SB CH OUT" surround parameter is set to "ON", and the PL II mode is set when this parameter is set to "OFF".

- When the "SB CH OUT" parameter is set to "ON". (Set "SP.Back" at the System Setup to "1spkr" or "2spkr").

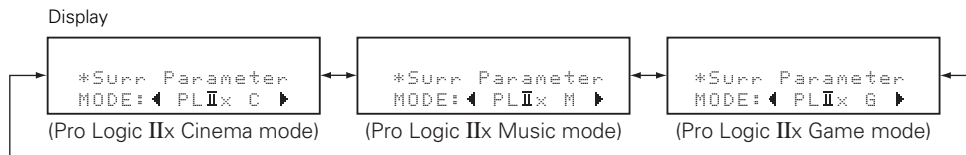

- When the "SB CH OUT" parameter is set to "OFF". (Set "SP.Back" at the System Setup to "None").

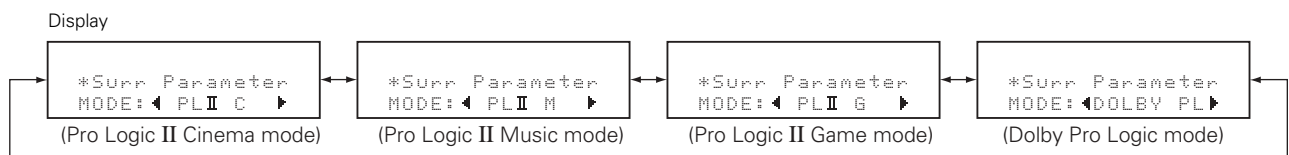

5

① Select the various surround parameters.

② Adjust the parameters setting.

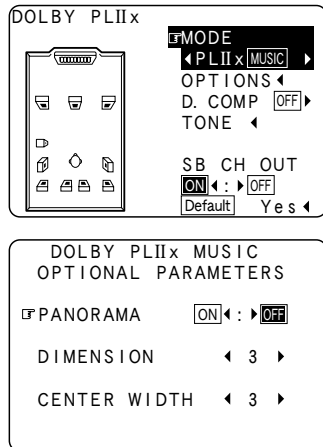
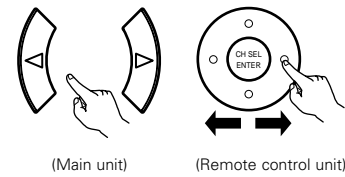
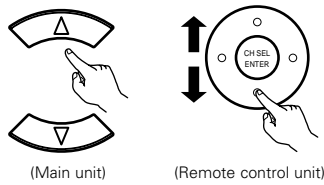

Example: DOLBY PL IIx music mode screen.

※ When set with the on-screen display using the Remote control unit while in the MUSIC mode, set the “☐” mark to “OPTION” using the Cursor up and down buttons, then press the Cursor left button. Press the ENTER button to return to the previous screen.

• DEFAULT setting

Select “Default Yes ◀”, then parameters set to default setting.

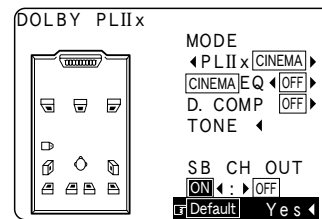
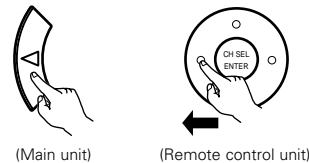

6



Press the ENTER or SURROUND PARAMETER button to complete the setting.

NOTE:

- There are four Dolby Surround Pro Logic modes (NORMAL, PHANTOM, WIDE and 3 STEREO). The AVR-5805 sets the mode automatically according to the types of speakers set during the system setup process (pages 46, 47).

Surround parameters ④

Pro Logic IIx and Pro Logic II Mode:

- Select one of the modes (“Cinema”, “Music”, “Pro Logic” or “Game”).
- The Cinema mode is for use with stereo television shows and all programs encoded in Dolby Surround.
- The Music mode is recommended for stereo music and surround-encoded stereo music sources.
- The Pro Logic mode emulates Dolby Laboratories’ original Dolby Pro Logic surround decoding, and may provide better results with older, legacy surround-encoded program material.
- The Game mode is optimized for computer and/or dedicated game box consoles, that feature stereo analog or digital outputs. It can only be used with 2-channel stereo sources.

Panorama Control:

This mode extends the front stereo image to include the surround speakers for an exciting “wraparound” effect with side wall imaging. Select “OFF” or “ON”.

Dimension Control:

This control gradually adjust the soundfield either towards the front or towards the rear. The control can be set in 7 steps from 0 to 6.

Center Width Control:

This control adjust the center image so it may be heard only from the center speaker; only from the left/right speakers as a phantom image; or from all three front speakers to varying degrees. The control can be set in 8 steps from 0 to 7.

DTS NEO:6 mode

- Surround playback can be performed for the analog input and digital input 2-channel signals.

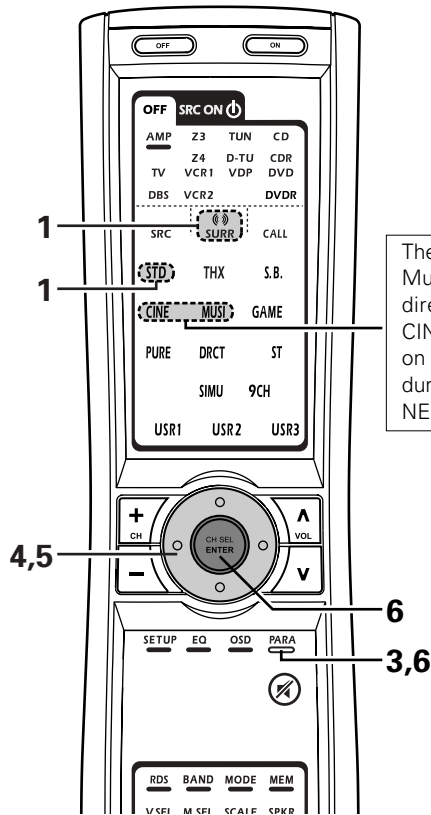
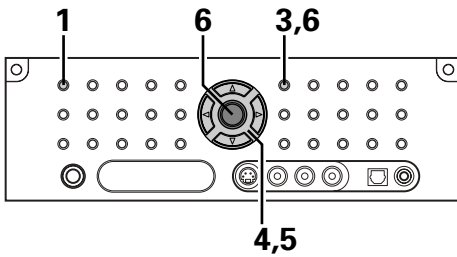

The DTS NEO:6 Cinema or Music mode can be chosen directly by pressing the CINEMA or MUSIC button on the Remote control unit during playback in the DTS NEO:6 mode.

1 Select the DTS NEO:6 mode.

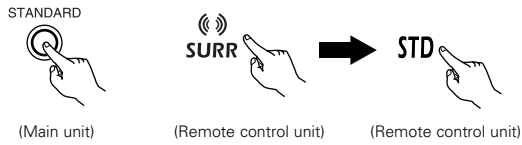

- The mode switches as shown below each time the STANDARD button is pressed.

DOLBY PL IIx ↔ DTS NEO:6

Light
DTS
NEO:6

- The DTS NEO:6 indicator lights.

2 Play a program source.

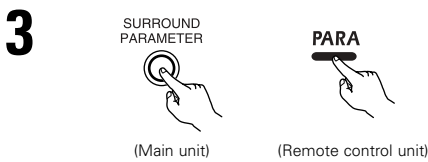

Display the Surround Parameter Menu.

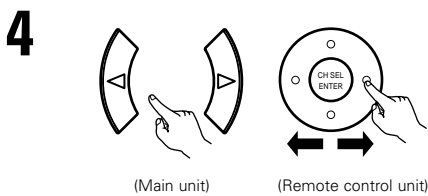
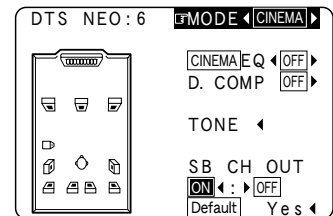

Select the play mode.

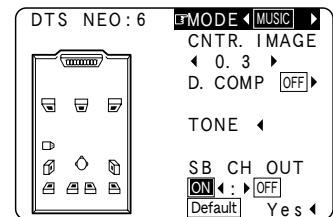

5 ① Select the various surround parameters.

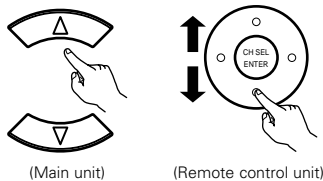

② Adjust the parameters setting.

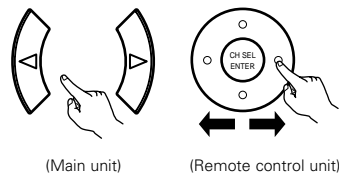

6

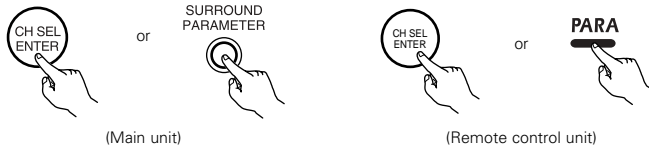

Press the ENTER or SURROUND PARAMETER button to complete the setting.

NOTE:

- When "Default" is selected and the Cursor left button is pressed, "MODE" and "TONE" are automatically reset to the default values and "CINEMA EQ" is set to "OFF".

Surround parameters ⑤

DTS NEO:6 Mode:

• **Cinema**

This mode is optimum for playing movies. Decoding is performed with emphasis on separation performance to achieve the same atmosphere with 2-channel sources as with 6.1-channel sources.

This mode is effective for playing sources recorded in conventional surround formats as well, because the in-phase component is assigned mainly to the center channel (C) and the reversed phase component to the surround (SL, SR and SB channels).

• **Music**

This mode is suited mainly for playing music. The front channel (FL and FR) signals bypass the decoder and are played directly so there is no loss of sound quality, and the effect of the surround signals output from the center (C) and surround (SL, SR and SB) channels add a natural sense of expansion to the sound field.

CENTER IMAGE (0.0 to 1.0: default 0.3):

The center image parameter for adjusting the expansion of the center channel in the DTS NEO:6 MUSIC mode has been added.

The Dolby Headphone

The Dolby Headphone mode is set when headphones are connected to the PHONES jack while in the DOLBY/DTS SURROUND mode.

- 1** When the SURROUND PARAMETER button is pressed, the parameter selection screen appears.

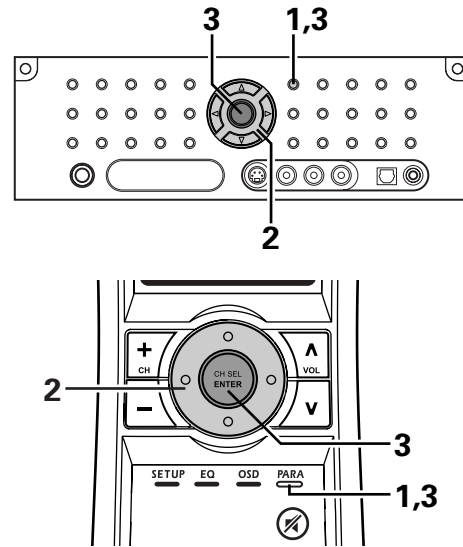
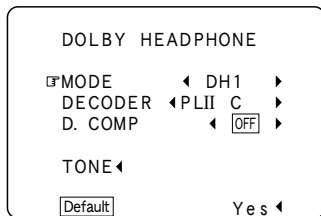

- 2** ① Select the parameters.



- ② Select the settings.

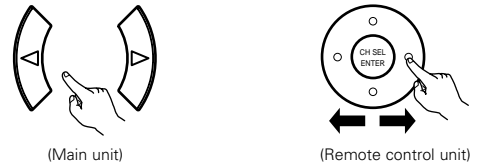

3

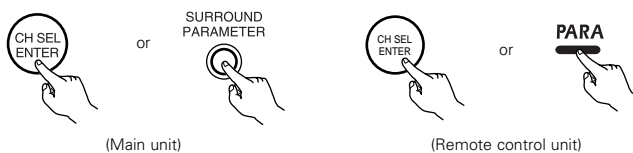

Press the ENTER or SURROUND PARAMETER button to complete the setting.

Parameters

MODE:

- DH1Reference room (small room with weak reverberations)
- DH2Live room (room with a bit stronger reverberations than DH1)
- DH3Large room (larger room than DH1, offers a sense of distance and sound diffusion effects)
- BYPASSStereo sound.

DECODER:

Select this when playing analog, PCM or other 2-channel sources.

The signals are converted into multichannel signals using the decoders shown below and played in the Dolby Headphone mode.

- PL II C.....Dolby Pro Logic II Cinema mode
- PL II M.....Dolby Pro Logic II Music mode
- NEO:6 C.....DTS NEO:6 Cinema mode
- NEO:6 M.....DTS NEO:6 Music mode
- OFF.....The signals are played in the Dolby Headphone mode as such (2 channels).

– Recording –

When RECOU mode is set to "SOURCE", with this amplifier signals encoded in the Dolby Headphone mode can be output from the recording output terminals and recorded on another recorder. (See page 133)

Memory and call-out functions (USER MODE function)

- The AVR-5805 is equipped with a function for storing the selected input source, the auto surround mode and input mode in the memory and selecting these settings when you want to use them.
- Three patterns of settings can be stored in the memory using the USER MODE 1, 2 and 3 buttons.

■ Storing the settings in the memory

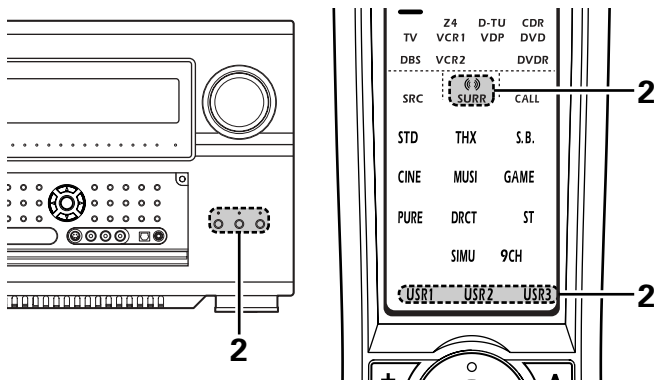

- 1** The following are stored in the memory:
- ① Currently set input source
 - ② Currently set auto surround mode
 - ③ Currently set input mode

- 2** Press and hold the USER MODE button at which you want to store the settings.
In this case, press the button and hold it in until the LED of the selected USER MODE button lights.

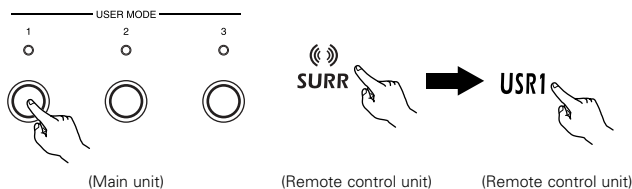

■ Calling the settings out

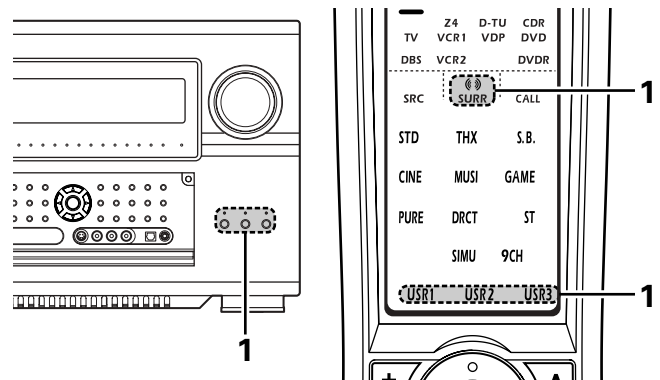

- 1** Press the USER MODE button at which the settings you want to call out are stored.
- The LED for the selected USER MODE button lights.
 - This LED turns off if you perform any operations that change the settings stored at the USER MODE buttons.

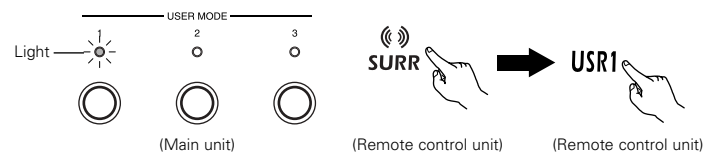

NOTE:

- When the Setup Lock function is activated, memory operation of the USER MODE button can not be performed.

11 DENON ORIGINAL SURROUND MODES

- The AVR-5805 is equipped with a high performance DSP (Digital Signal Processor) which uses digital signal processing to synthetically recreate the sound field. One of ten preset surround modes can be selected according to the program source and the parameters can be adjusted according to the conditions in the listening room to achieve a more realistic, powerful sound.

Surround modes and their features

1	WIDE SCREEN	Select this to achieve an atmosphere like that of a movie theater with a large screen. In this mode, all signal sources are played in the 7.1-channel mode, including Dolby Pro Logic and Dolby Digital 5.1-channel sources. Effects simulating the multi surround speakers of movie theaters are added to the surround channels.
2	SUPER STADIUM	Select this when watching baseball or soccer programs to achieve a sound as if you were actually at the stadium. This mode provides the longest reverberation signals.
3	ROCK ARENA	Use this mode to achieve the feeling of a live concert in an arena with reflected sounds coming from all directions.
4	JAZZ CLUB	This mode creates the sound field of a live house with a low ceiling and hard walls. This mode gives jazz a very vivid realism.
5	CLASSIC CONCERT	Select this for the sound of a concert hall rich in reverberations.
6	MONO MOVIE (NOTE 1)	Select this when watching monaural movies for a greater sense of expansion.
7	VIDEO GAME	Use this to enjoy video game sources.
8	MATRIX	Select this to emphasize the sense of expansion for music sources recorded in stereo. Signals consisting of the difference component of the input signals (the component that provides the sense of expansion) processed for delay are output from the surround channel.
9	VIRTUAL	Select this mode to enjoy a virtual sound field, produced from the front 2-channel speakers. ※ This mode can be selected when surround playback is being performed in Zone2.
10	9CH STEREO	The front left channel signals are output to the surround and surround back signal left channels, the front right channel signals are output to the surround and surround back signal right channels, and the in-phase component of the left and right channels is output to the center channel. Use this mode to enjoy stereo sound.

※ Depending on the program source being played, the effect may not be very noticeable.

In this case, try other surround modes, without worrying about their names, to create a sound field suited to your tastes.

(NOTE 1): When playing sources recorded in monaural, the sound will be one-sided if signals are only input to one channel (left or right), so input signals to both channels. If you have a source component with only one audio output (monophonic camcorder, etc.) obtain a "Y" adaptor cable to split the mono output to two outputs, and connect to the L and R inputs.

Personal Memory Plus

This set is equipped with a personal memorize function that automatically memorizes the surround modes and input modes selected for the input different sources. When the input source is switched, the modes set for that source last time it was used are automatically recalled.

※ The surround parameters, tone control settings and playback level balance for the different output channels are memorized for each surround mode.

DSP surround simulation

1 Select the surround mode for each input channel.

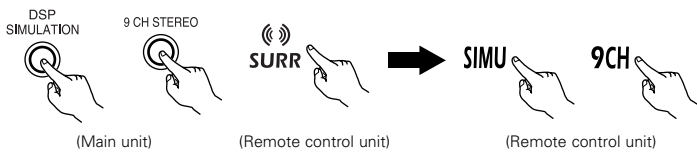

The surround mode switches in the following order each time the DSP SIMULATION button is pressed:

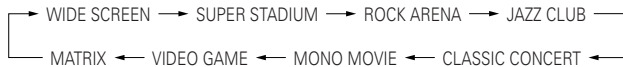

2 Press the SURROUND PARAMETER button.

Display the Surround Parameter Menu.
 ※ The screen for the selected surround mode appears.

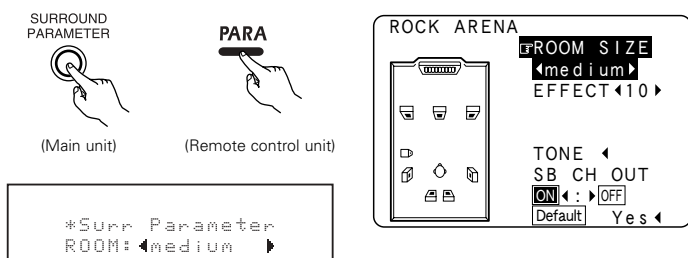

3 ① Select the various surround parameters.



② Adjust the parameters setting.



4 Press the ENTER or SURROUND PARAMETER button to complete the setting.

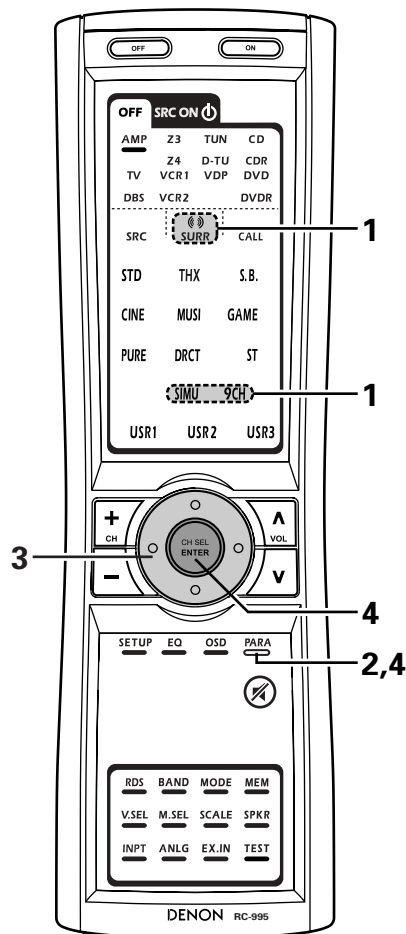
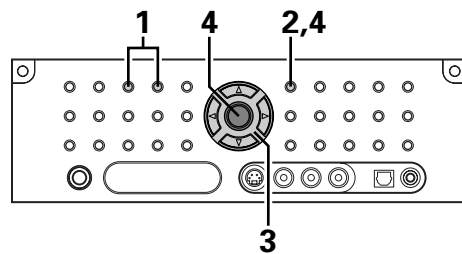
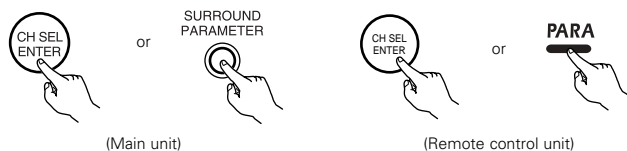

※ The "9CH STEREO" display changes as shown below according to the surround back speaker setting and the surround speaker setting.

SURROUND BACK SPEAKER	SURROUND SPEAKER SETTING	DISPLAY
ON	A + B	9 CH STEREO
	A or B	7 CH STEREO
OFF	A + B	7 CH STEREO
	A or B	5 CH STEREO

NOTES:

- The surround speaker setting can also be changed with the SPEAKER button on the Main unit or Remote control unit.
- When "Default" is selected and the Cursor left button is pressed, "CINEMA EQ." and "D.COMP." are automatically turned off, "ROOM SIZE" is set to "medium", "EFFECT LEVEL" to "10", "DELAY TIME" to "30ms" and "LFE" to "0dB".
- The "ROOM SIZE" expresses the expansion effect for the different surround modes in terms of the size of the sound field, not the actual size of the listening room.
- When playing PCM digital signals or analog signals in the DOLBY PRO LOGIC II, DOLBY PRO LOGIC IIx, DTS NEO:6 modes and the input signal switches to a digital signal encoded in Dolby Digital, the Dolby surround mode switches automatically. When the input signal switches to a DTS signal, the mode automatically switches to DTS surround.

Tone control setting

- Use the tone control setting to adjust the bass and treble as desired.
- The tone control function will not work in the PURE DIRECT, DIRECT or Home THX Cinema mode.

[1] Adjusting the tone using the Remote control unit

1  Press the SURROUND PARAMETER button. Display the Surround Parameter Menu.
 ※ The screen selected surround mode appears.

(Remote control unit)

*Surr Parameter
 ROOM: ◀medium▶

ROCK ARENA
 ROOM SIZE
 ◀medium▶
 EFFECT ◀10▶
 TONE ◀
 SB CH OUT
 ON ◀: ▶ OFF
 Default Yes ◀

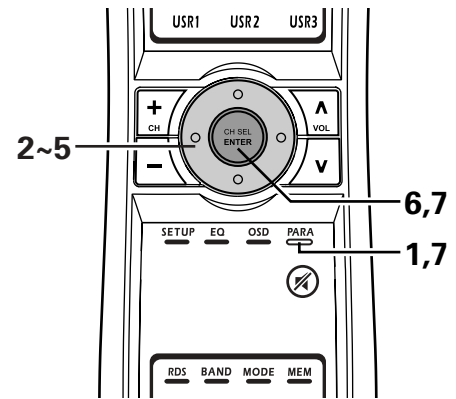

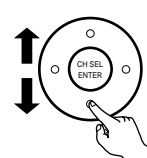
2  Select "TONE".

(Remote control unit)

*Surr Parameter
 TONE ◀

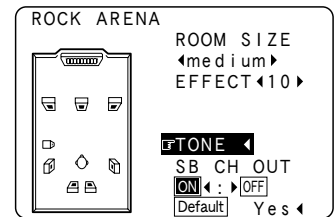

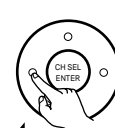
3  Switch to Tone Control screen.

(Remote control unit)

*Tone Control
 Tone Def.: ON ▶

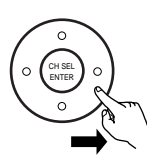

4  Select Tone Defeat OFF.

(Remote control unit)

*Tone Control
 Tone Def.: ◀OFF

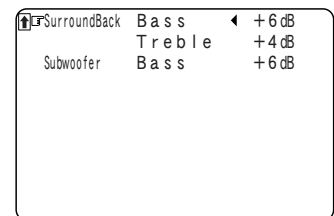
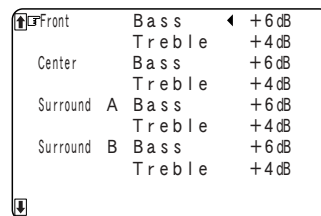

5

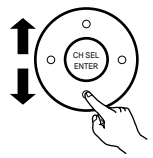

(Remote control unit)

① Select Bass or Treble.

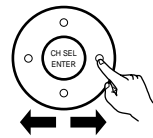

(Remote control unit)

② Set the level.

6



(Remote control unit)

Enter the setting.
The Surround Parameter Menu screen re-appears.

7



(Remote control unit)

or



Press the ENTER or SURROUND PARAMETER button to complete the setting.

[2] Adjusting the tone from the Main unit

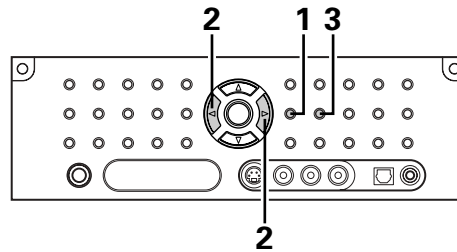

1



(Main unit)

The tone switches as follows each time the TONE CONTROL button is pressed.

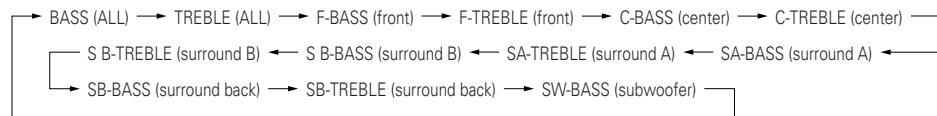

2

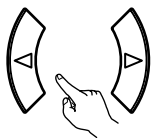

(Main unit)

Select with the name of the volume to be adjusted and adjust the level.

- To increase the bass or treble:
The bass or treble sound can be increased to up to +6 dB in steps of 1 dB.
- To decrease the bass or treble:
The bass or treble sound can be decreased up to -6 dB in steps of 1 dB.

3



(Main unit)

If you do not want the bass and treble to be adjusted, turn on the tone defeat mode.

※ The signals do not pass through the bass and treble adjustment circuits, providing higher quality sound.

Surround parameters ⑥

EFFECT:

This parameter turns the effect signals with multi surround mode speaker effects on and off in the WIDE SCREEN mode. When this parameter is turned off, the SBL and SBR channel signals are equivalent to the SL and SR channels, respectively.

LEVEL:

This parameter sets the strength of the effect signals in the WIDE SCREEN mode. It can be set in 15 steps, from "1" to "15". Set this to a low level if the positioning or phase of the surround signals sounds unnatural.

SB CH OUT:

"ON"Playback is conducted using the surround back speaker.

"OFF"Playback is conducted without using the surround back speaker.

NOTE: This operation can be performed directly using the SURROUND BACK button on the Main unit's panel.

ROOM SIZE:

This sets the size of the sound field.

There are five settings: "small", "med.s" (medium-small), "medium", "med.l" (medium-large) and "large". "small" recreates a small sound field, "large" a large sound field.

EFFECT LEVEL:

This sets the strength of the surround effect.

The level can be set in 15 steps from 1 to 15. Lower the level if the sound seems distorted.

DELAY TIME:

In the matrix mode only, the delay time can be set within the range of 0 to 300 ms.

SW ATT:

This parameter for reducing the level of the subwoofer channel when playing in the EXT. IN input mode has been added. Depending on the player you are using, the subwoofer channel's playback level may seem too high. If so, set "SW ATT" to "ON".

For Denon players, use with the default settings.

Subwoofer ON/OFF:

The subwoofer output can be controlled directly.

12 MULTI ZONE

Multi-zone playback with multi-source

MULTI ZONE MUSIC ENTERTAINMENT SYSTEM

- When the outputs of the "ZONE2 (ZONE3, ZONE4)" OUT terminals are wired and connected to integrated or power amplifiers installed in other rooms, different sources can be played in rooms other than the MAIN ZONE in which this unit and the playback devices are installed. (Refer to ZONE2 (ZONE3, ZONE4) on the diagram below.)
 - Settings can be made at "7-2. Power Amp Assign" in the System Setup Menu so that the same source as the ZONE2 (ZONE3, ZONE4) pre-out terminals can be played from the speakers connected to the ZONE2 (ZONE3, ZONE4) speaker terminals. (See pages 101~105)
 - When a sold separately room-to-room Remote control unit (DENON RC-616, 617 or 618) is wired and connected between the MAIN ZONE and ZONE2 (ZONE3, ZONE4), the remote-controllable devices in the MAIN ZONE can be controlled from ZONE2 (ZONE3, ZONE4) using the Remote control unit.
- ※ To control playback devices other than the ones above, either use that device's Remote control unit or preset a separately sold programmable Remote control unit.

NOTES:

- For the AUDIO output, use high quality pin-plug cords and wire in such a way that there is no humming or noise.
- For instructions on installation and operation of separately sold devices, refer to the devices' operating instructions.
- The multi zone video output is not output in the Video OFF modes.

MULTI ZONE MUSIC ENTERTAINMENT SYSTEM

[1] ZONE2 playback

The AVR-5805 is equipped with pre-out terminals for which the volume is adjustable and video output terminals (composite, S-Video and component) as the ZONE2 output terminals.

A separately sold power amplifier or preamplifier can be connected to enjoy ZONE2 playback.

■ ZONE2 5.1-channel system

- 5.1 channel playback is possible in ZONE2 if "5.1CH" is selected for the ZONE2 playback channel setting at "7-1. Channel Setup" (pages 97~100) in the System Setup Menu. (Default setting of ZONE2 channel is "5.1CH".)

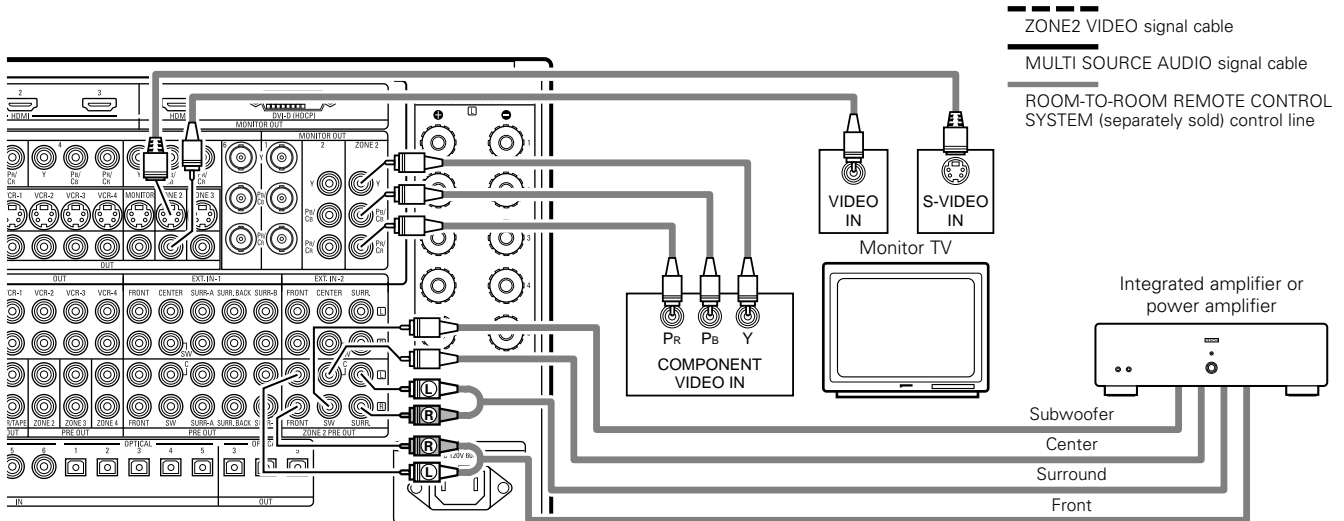
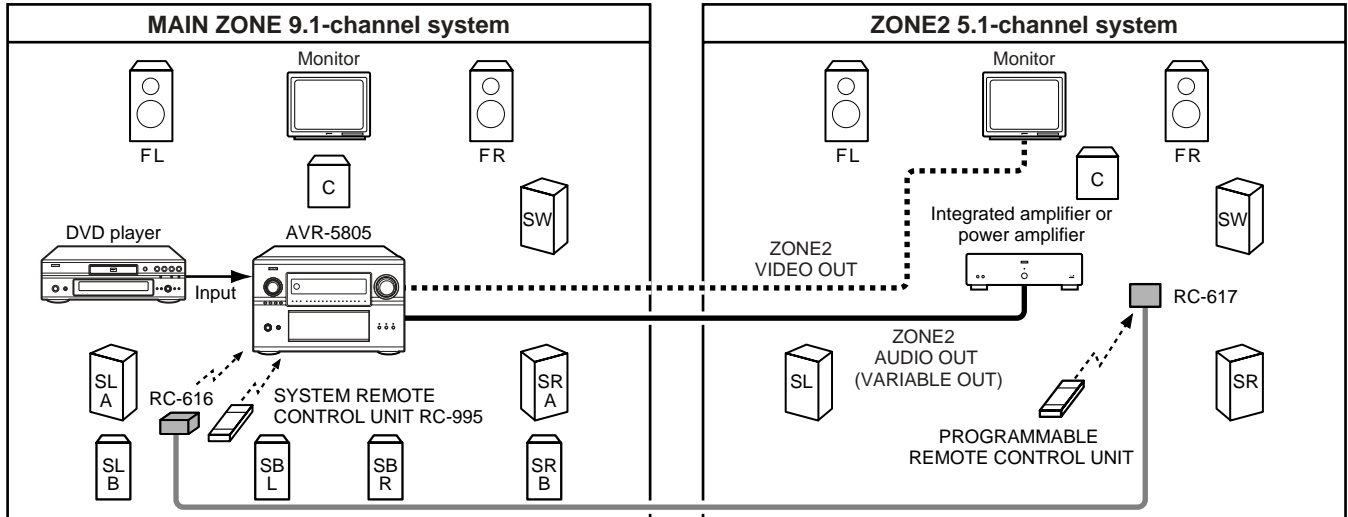

■ **ZONE2 7.1-channel system**

- 7.1 channel playback is possible in ZONE2 if "7.1CH" is selected for the ZONE2 channel setting at "7-1. Channel Setup" in the System Setup Menu.

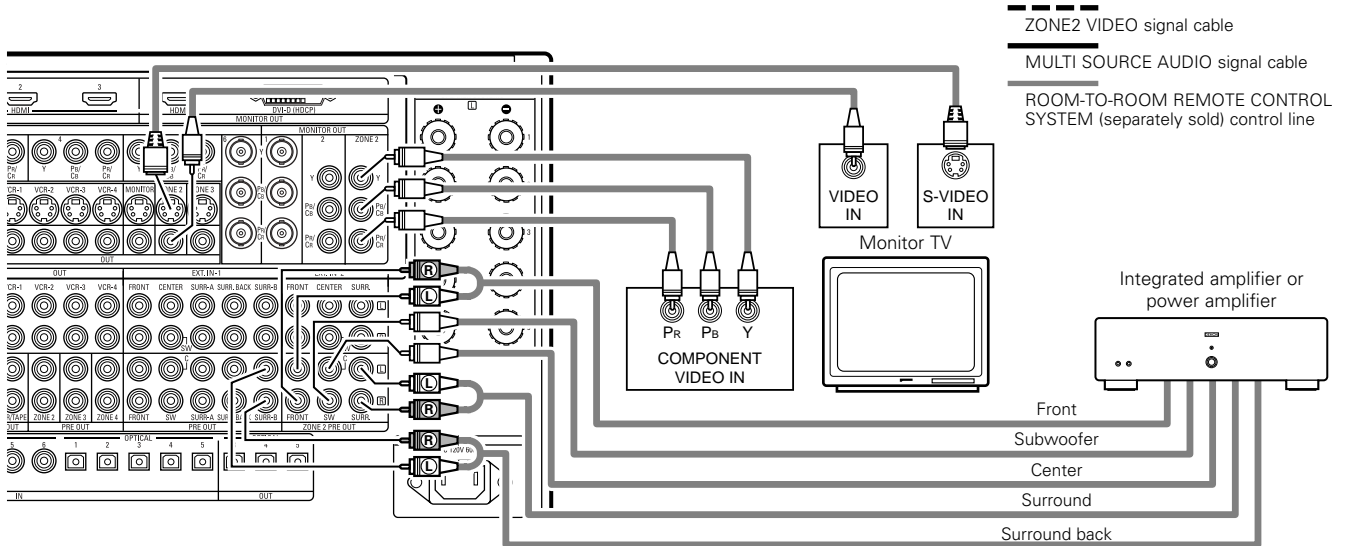
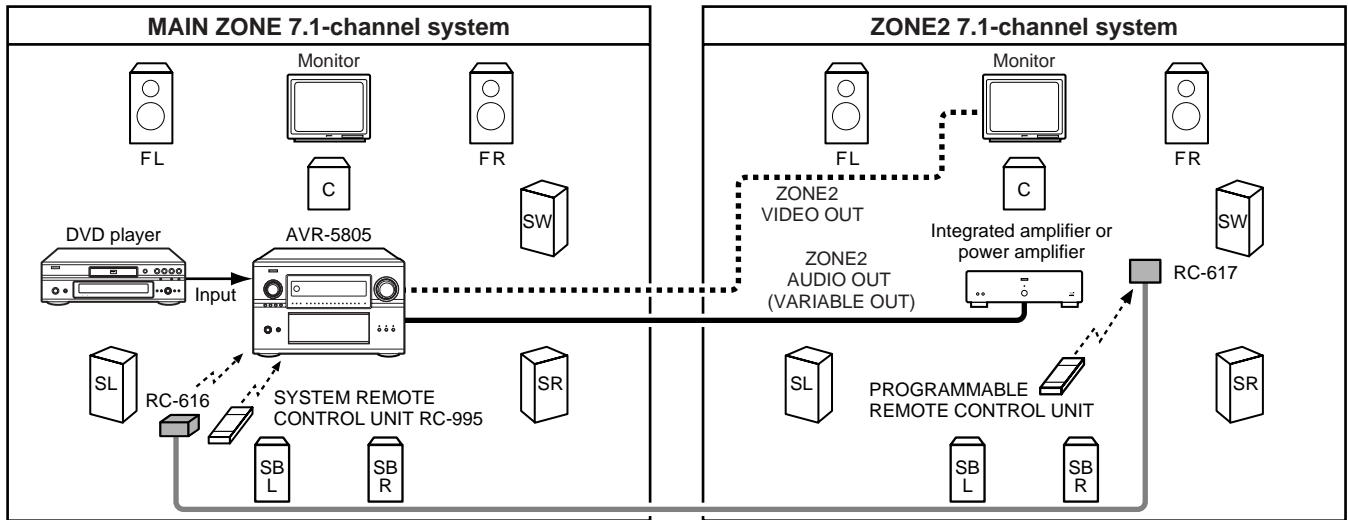

■ ZONE2 STEREO/MONO system

- When two speakers are being used in ZONE2, select “STEREO” for the ZONE2 channel setting at “7-1. Channel Setup” in the System Setup Menu. Stereo sound can be enjoyed in ZONE2.
- When only one speaker is being used in ZONE2, select “MONO” for the ZONE2 channel setting at “7-1. Channel Setup” in the System Setup Menu. In this case, monaural sound can be enjoyed in ZONE2.

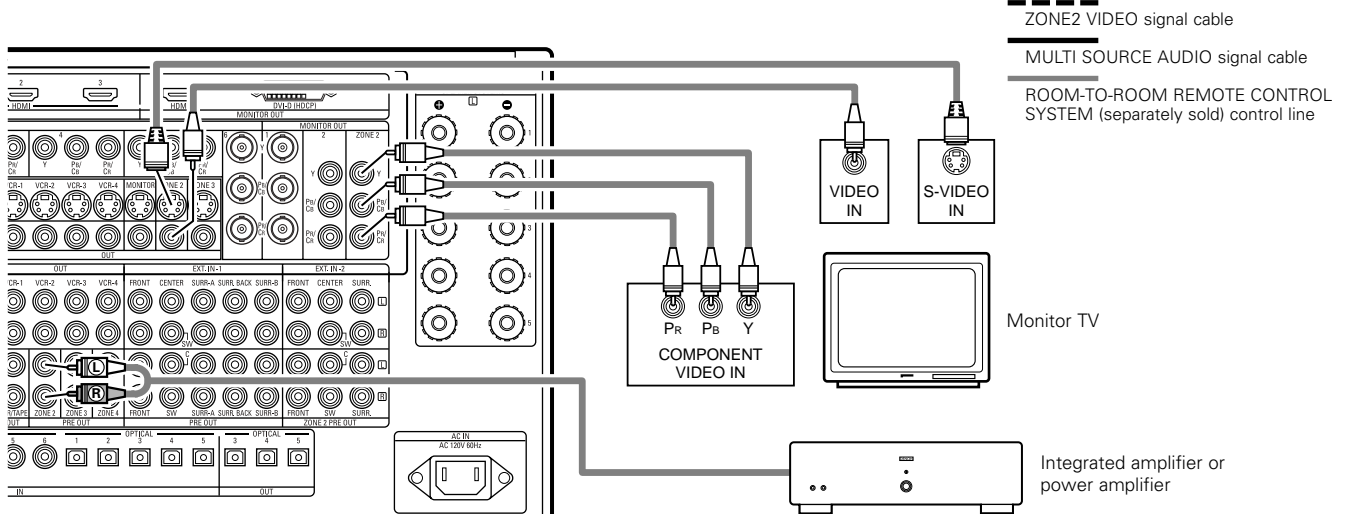
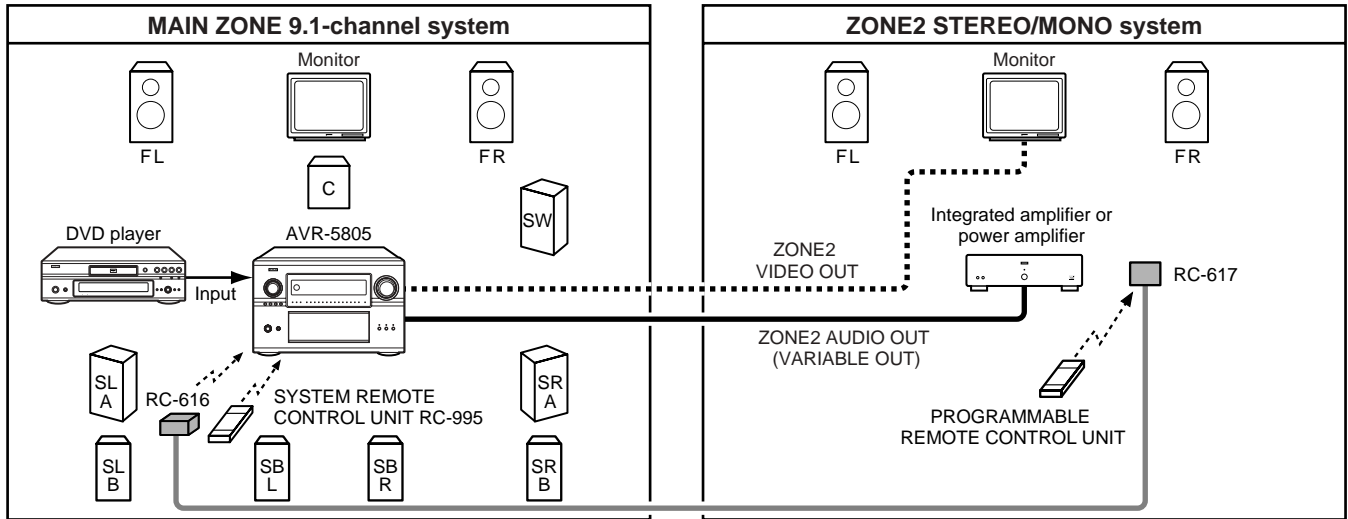

[2] ZONE3 playback

The AVR-5805 is equipped with pre-out terminals for which the volume is adjustable and video output terminals (composite and S-Video) as the ZONE3 output terminals.

■ ZONE3 STEREO/MONO system

- Stereo and monaural sound can be enjoyed in ZONE3. (By default, "STEREO" is selected.)
- When only one speaker is being used in ZONE3, select "MONO" for the ZONE3 channel setting at "7-1. Channel Setup" in the System Setup Menu.

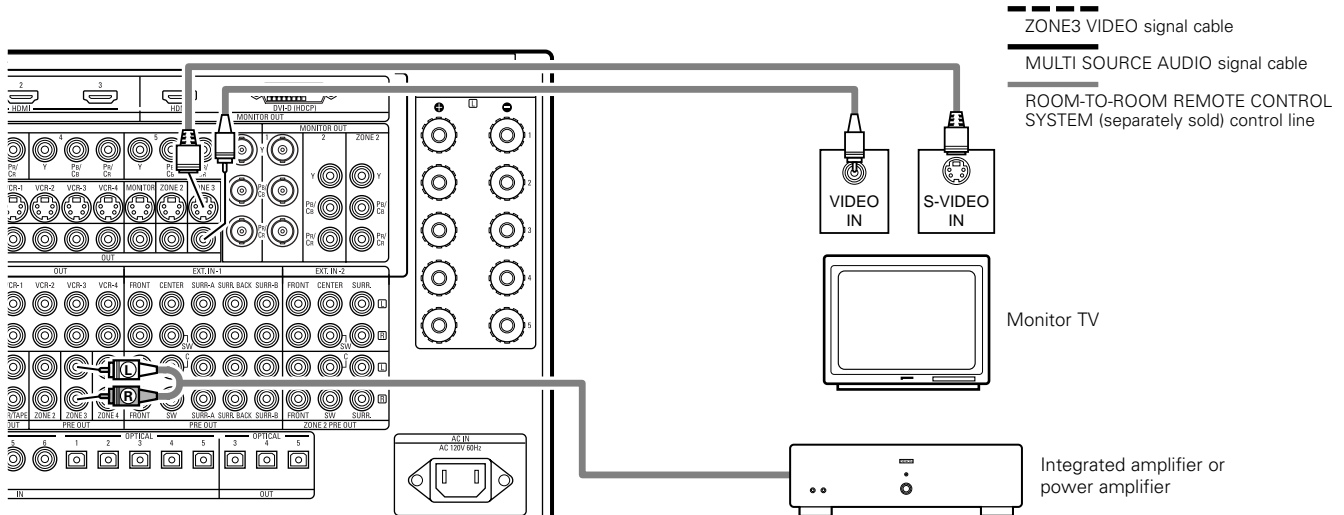
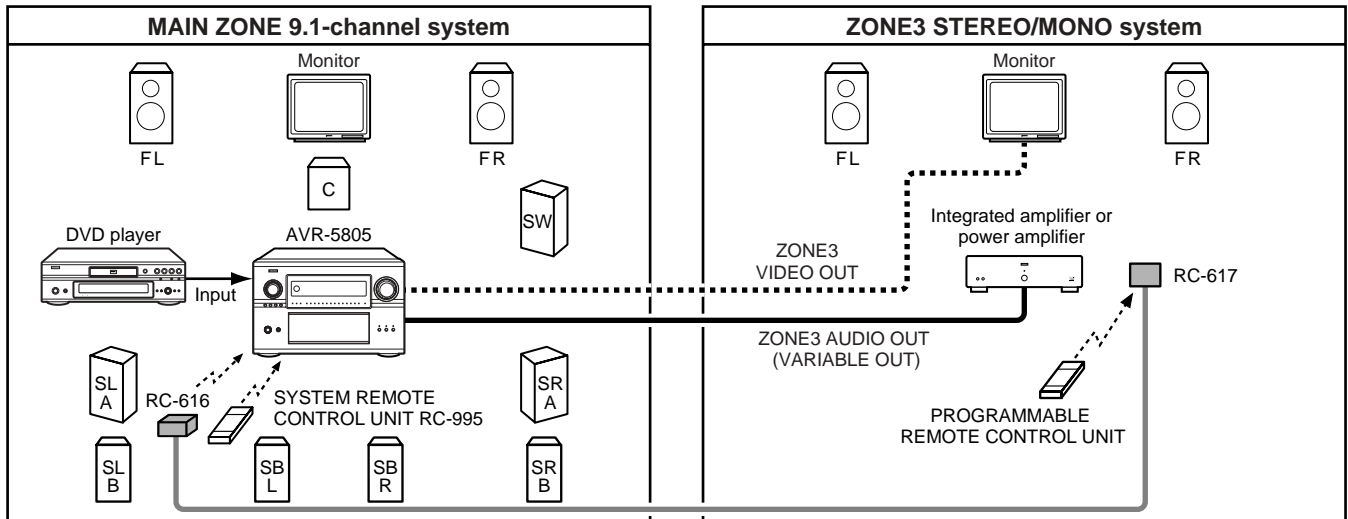

[3] ZONE4 playback

The AVR-5805 is equipped with pre-out terminals for which the volume is adjustable as the ZONE4 output terminals.

■ ZONE4 STEREO/MONO system

- Stereo and monaural sound can be enjoyed in ZONE4. (By default, "STEREO" is selected.)
- When only one speaker is being used in ZONE4, select "MONO" for the ZONE4 channel setting at "7-1. Channel Setup" in the System Setup Menu.

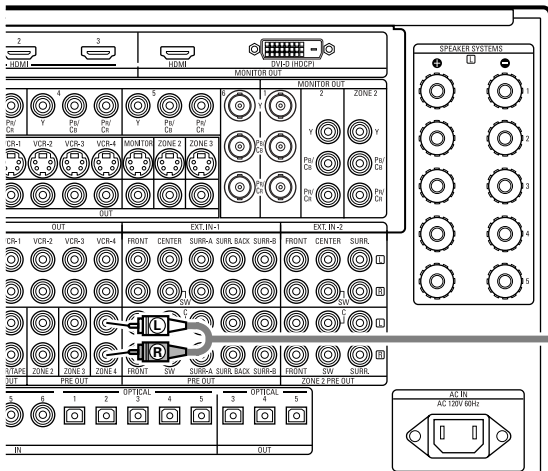
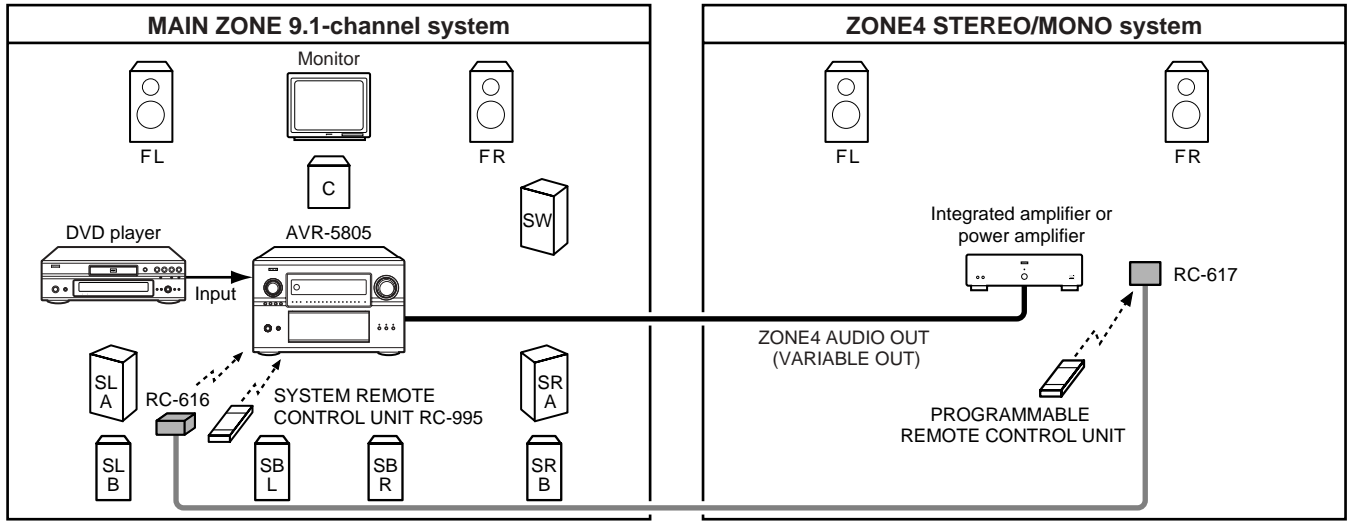

— MULTI SOURCE AUDIO signal cable
 - - - ROOM-TO-ROOM REMOTE CONTROL SYSTEM (separately sold) control line

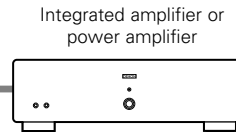

[4] Outputting a program source to an amplifier, etc., in a ZONE2 room (ZONE2 SELECT mode)

- 1** Press the ZONE2 SELECT button.



ZONE 2
SELECT
(Main unit)
- 2** Select the source you want to output appears on the set's display.

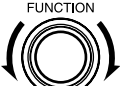

FUNCTION
(Main unit)
- 3** Start playing the source to be output.

 - For operating instructions, refer to the manuals of the respective components.

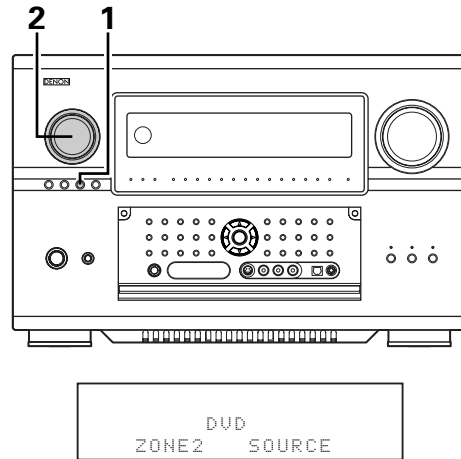

[5] Outputting a program source to an amplifier, etc., in a ZONE3 or ZONE4 room (ZONE3, ZONE4 SELECT mode)

- 1** Press the ZONE3/4/REC SELECT button. The display switches as follows each time the button is pressed.



ZONE 3 / 4
REC SELECT
(Main unit)

ZONE3 ←→ ZONE4
(REC OUT)
- 2** With "ZONE3 SOURCE" displayed, turn the FUNCTION knob and select the source you wish to output.

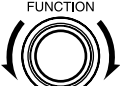
 - The MULTI indicator light.
 - The display switches the selected source.

FUNCTION
(Main unit)
- 3** Start playing the source to be output.

 - For operating instructions, refer to the manuals of the respective components.

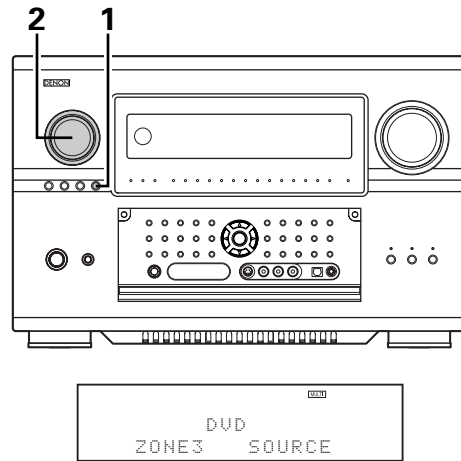

※ The ZONE4 SELECT can also be set with a method similar to the above.

NOTES:

- The signals of the source selected in the ZONE3 mode are also output from the VCR-1, VCR-2, VCR-3, VCR-4 and CDR/TAPE recording output jacks.
- Digital signals are not output from the Zone4 audio output jacks.
- Refer to pages 152~156 about the MULTI ZONE connections.

Remote control unit operations during multi-source playback

1 Select the Zone which you want to operate using the mode selector buttons.

Example: ZONE2



(Remote control unit)



(Remote control unit)

Press the SOURCE ON button to turn on the Zone power.

- The multi zone power indicator on Main unit is light.
- ※ Press the SOURCE OFF button to turn off the Zone power. The multi zone power indicator on Main unit is off.



(Remote control unit)

Select the input source you wish to output.



(Remote control unit)

Select the input mode. (only ZONE2 mode)

- Selecting the analog mode
Press the ANALOG button to switch to the analog input.



(Remote control unit)

- Selecting the digital mode
Press the INPUT MODE button to switch to the digital input.

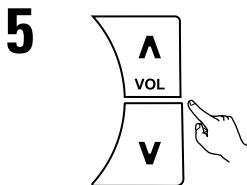

(Remote control unit)

The volume of the outputs of the different zones can be adjusted with the VOLUME + and - buttons on the Remote control unit.

The output level can be controlled only if the zone volume level is set "variable" at "7-3. Volume Control" in the System Setup Menu. (See pages 106, 107)

※ DEFAULT VOLUME SETTING

ZONE2 : -40 dB

ZONE3 : -40 dB

ZONE4 : -40 dB

※ The Zone volume can be adjusted within the range of -80 to 18 dB, in steps of 1 dB.

However, when using with ZONE2 set to multi-channel (5.1- or 7.1-channel), the Zone2 volume can be adjusted in steps of 0.5 dB. (See pages 97~100)



(Remote control unit)

Use this to mute the audio temporarily.

Press the MUTING button.

※ The Muting level is same as set with "7-3. Volume Level".

※ Cancelling MUTING mode.

Press the MUTING button again, or press the volume up or down buttons on the remote control.



(Remote control unit)

To combine the sound being played in ZONE2 with the desired image:

Press the Remote control unit's ZONE2 VIDEO SELECT button until the desired image appears on the ZONE2 monitor out.

The video source selected with the video select function is stored in the memory for the different ZONE2 input sources.

※ Canceling simulcast playback.

Select "SOURCE" using the ZONE2 VIDEO SELECT button.



(Remote control unit)

On screen display

Each time an operation is performed, a description of that operation appears on the display connected to AVR-5805's ZONE2 MONITOR OUT jack. Also, the unit's operating status can be checked during playback by pressing the Remote control unit's ON SCREEN button.

Such information as the position of the input selector and the surround parameter settings is output in sequence. For details, see page 138.

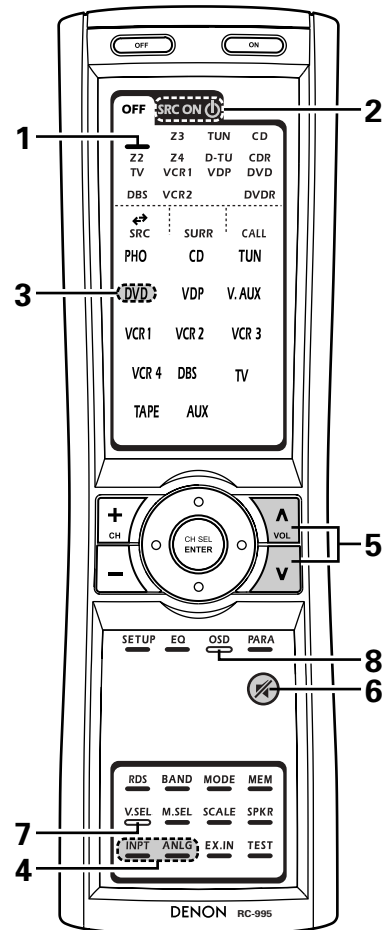

System setup for multi-zone

- This makes it possible to make the optimum setting for the speaker systems used in Zone2.

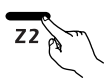
1  Select the ZONE2 mode using the AMP/Z2 button.
(Remote control unit)

2  Press the SYSTEM SETUP button and display the ZONE2 System Setup Menu.
(Remote control unit)

※ The screen displayed depends on the settings made at "7-1. Channel Setup" (pages 97~100).

6. Zone Setup

- 1. Speaker Config.
- 2. Subwoofer Mode
- 3. Delay Time
- 4. Channel Level
- 5. Crossover Frequency
- 6. Video Setup
- 7. Zone3/4 Tone/Ch Lev.
- Exit

Example: 5.1 or 7.1-channel system

6. Zone Setup

- 1. Zone2 Tone/Ch Lev.
- 2. Zone3 Tone/Ch Lev.
- 3. Zone4 Tone/Ch Lev.
- 4. Video Setup
- Exit

Example: STEREO or MONO system

For instructions on making the settings, see pages 85~96.

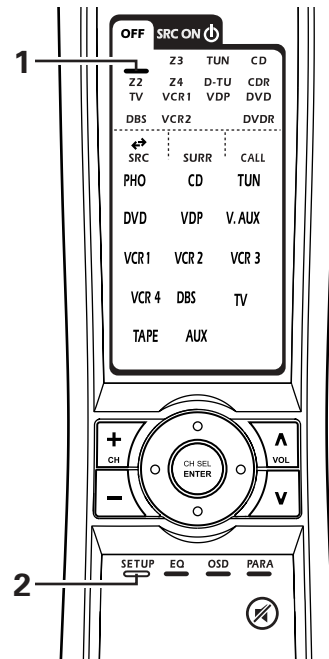

Adjustment steps that need to be performed prior to surround sound playback in Zone2

[1] Test Tone

- Before playing with the surround function, be sure to use the test tones to adjust the playback level from the different speakers. This adjustment can be performed with the system setup (see pages 90, 91) or from the Remote control unit, as described below.
- Adjusting with the Remote control unit using the test tones is only possible in the "Auto" mode and only effective in the STANDARD (DOLBY/DTS SURROUND) modes. The adjusted levels for the different modes are automatically stored in the memory.

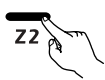
1  Select the ZONE2 mode using the AMP/Z2 button.
(Remote control unit)

2  Press the TEST TONE button.
(Remote control unit)

The Test Tone screen is displayed on the Zone2 monitor out.

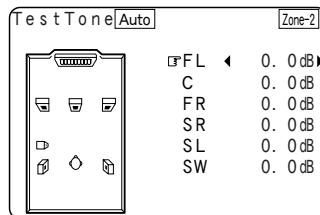

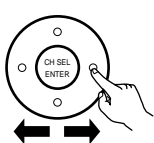
3  Test tones are output from the different speakers used in Zone2. Use the channel volume adjust buttons to adjust so that the volume of the test tones is the same for all the speakers.
(Remote control unit)

4  After completing the adjustment, press the TEST TONE button again.
(Remote control unit)

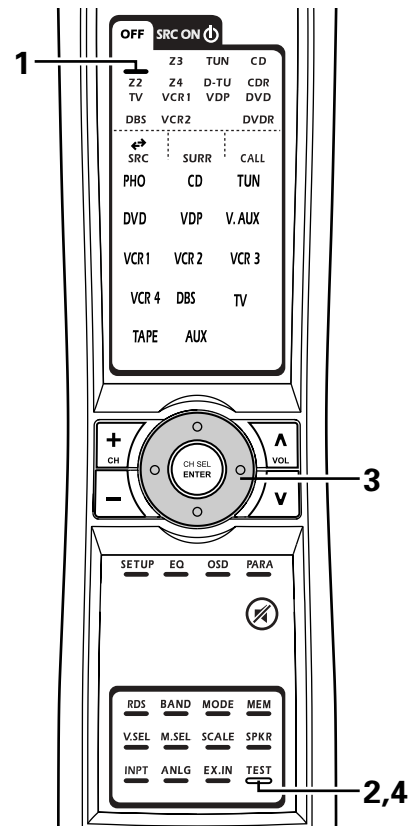

[2] Channel Level

- After adjusting using the test tones, adjust the channel levels either according to the playback sources or to suit your tastes, as described below.

1  Select the ZONE2 mode using the AMP/Z2 button.
(Remote control unit)

2  The channel Volume is displayed at Zone2 monitor out.
(Remote control unit)

Channel Vol.			
FL	◀ 0.0dB	SR	0.0dB
C	0.0dB	SBR	0.0dB
FR	0.0dB	SBL	0.0dB
SW	0.0dB	SL	0.0dB
Fader			
FRONT ◀ : ▶ REAR			

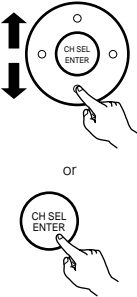
3  Select the speaker level you want to adjust.
• When pressing the ENTER button, the channel switches as shown below each time the ENTER button is pressed.
(Remote control unit)

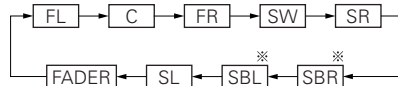

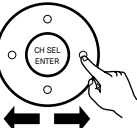
4  Adjust the level of the selected speaker.
• The adjustment range for the different channels is +12 dB to -12 dB.
• The sound from the subwoofer can be completely cut by lowering the SW (subwoofer) setting one additional step from -12 dB (setting it to "OFF").
(Remote control unit)

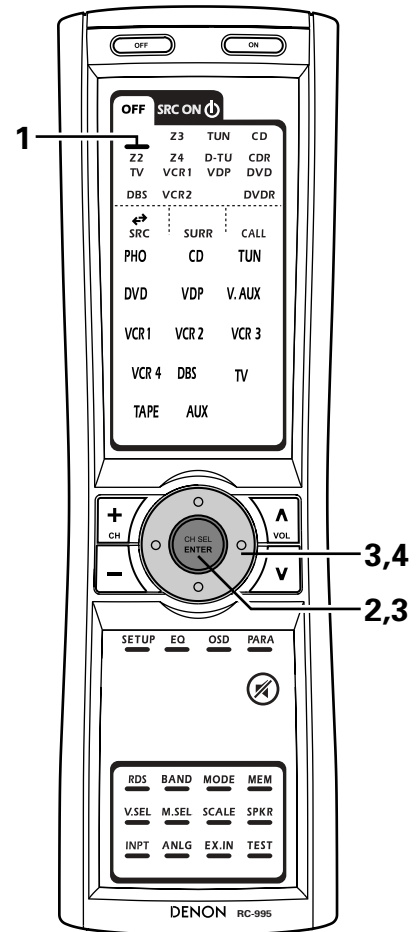

- ※ Zone2 surround back speakers are only displayed when "7.1ch" is selected for the Zone2 channel output setting at "7-1. Channel Setup".
- ※ When the Zone2 surround back speaker setting is set to "1spkr" for "6-1. Speaker Configuration", this is set to "SB".

Fader function

- This function makes it possible to lower the volume of the front channels (FL, C and FR) or the rear channels (SL, SR, SBL and SBR) of Zone2 together. Use it for example to adjust the balance of the sound from each position when multi-channel music sources are played.

1  Select the ZONE2 mode using the AMP/Z2 button.
(Remote control unit)

2  The Channel Volume screen is displayed at Zone2 monitor out.
(Remote control unit)

Channel Vol.			
FL	◀ 0.0dB ▶	SR	0.0dB
C	0.0dB	SBR	0.0dB
FR	0.0dB	SBL	0.0dB
SW	0.0dB	SL	0.0dB
Fader FRONT ◀ : ▶ REAR			

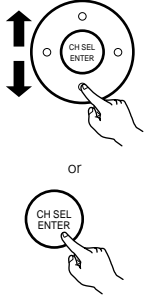
3  Select "FADER".
• When pressing the ENTER button, the channel switches in order shown below each time the ENTER button is pressed.

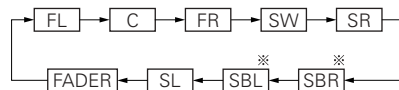

Channel Vol.			
FL	0.0dB	SR	0.0dB
C	0.0dB	SBR	0.0dB
FR	0.0dB	SBL	0.0dB
SW	0.0dB	SL	0.0dB
Fader FRONT ◀ : ▶ REAR			

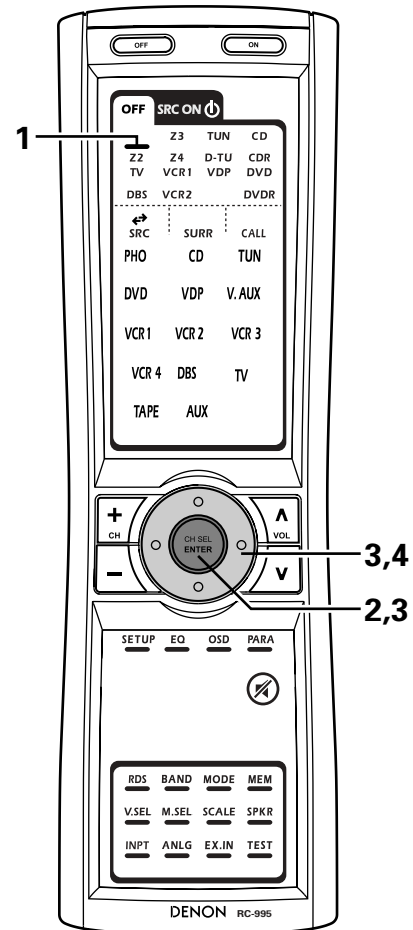

- ※ Zone2 surround back speakers are only displayed when "7.1ch" is selected for the Zone2 channel output setting at "7-1. Channel Setup".
- ※ When the Zone2 surround back speaker setting is set to "1spkr" for "6-1. Speaker Configuration", this is set to "SB".

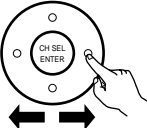
4  Press the Cursor left button to reduce the volume of the front channels, the Cursor right button to reduce the volume of the rear channels.
(Remote control unit)

- ※ The fader function does not affect the SW channel.
- The channel whose channel level is adjusted lowest can be faded to -12 dB using the fader function.
- If the channel levels are adjusted separately after adjusting the fader, the fader adjustment values are cleared, so adjust the fader again.

Zone2 Surround

- When Zone2 is used with a 5.1- or 7.1-channel system, various surround modes can be selected according to the program source being played.
- The desired sound field can be achieved by adjusting the parameters for the various surround modes.

1 Select the ZONE2 mode using the AMP/Z2 button.

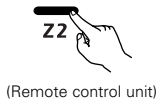

2 Select the surround mode.

- ① Dolby Digital and DTS surround mode. ② DSP surround simulation mode.

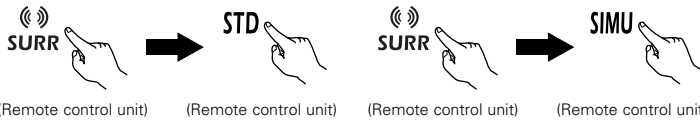

The surround mode switches in the following order each time the DSP SIMULATION button is pressed:

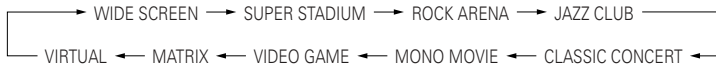

- ③ STEREO mode. ④ 5CH/7CH STEREO mode.

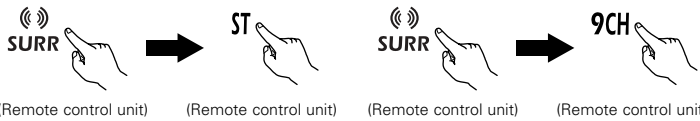

※ See pages 129, 140~144, 147 for a description of the features of the various surround modes.

NOTE:

- The following surround modes can be selected in Zone2: STEREO, DOLBY/DTS SURROUND, 5/7CH STEREO, WIDE SCREEN, SUPER STADIUM, ROCK ARENA, JAZZ CLUB, CLASSIC CONCERT, MONO MOVIE, VIDEO GAME, MATRIX and VIRTUAL.

3 Press the SURROUND PARAMETER button.
Display the Surround Parameter Menu.



4 ① Select the various parameters.

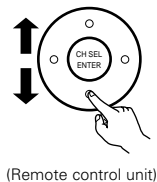

② Adjust the parameter settings.

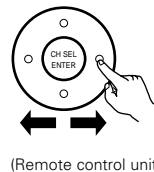

5 Press the ENTER or SURROUND PARAMETER button to complete the setting.

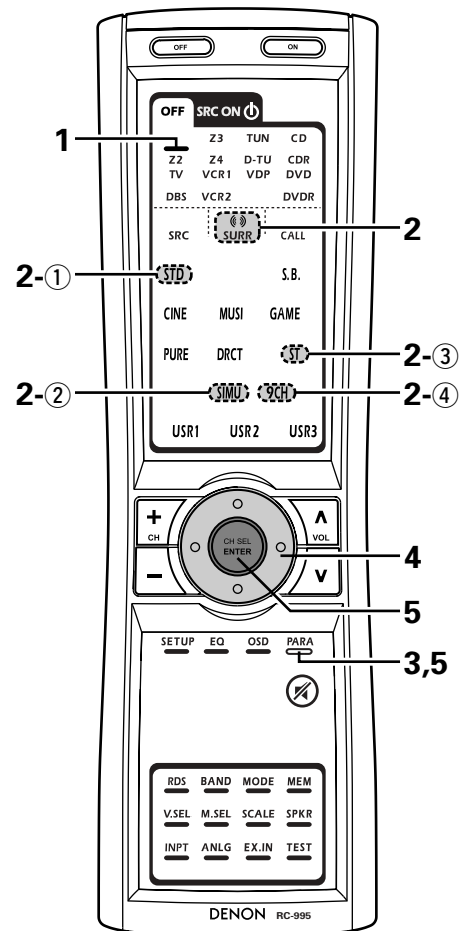
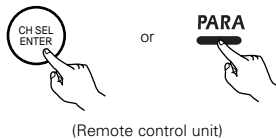

Memory and call-out functions of Zone2 (USER MODE function)

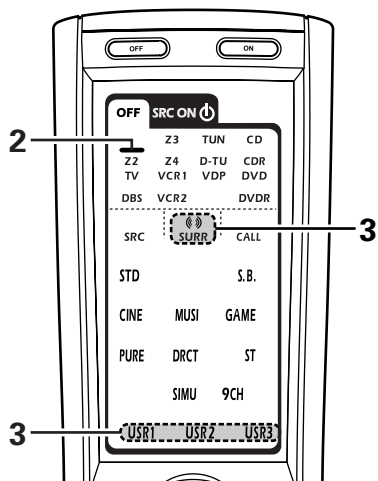

- The AVR-5805 is equipped with a function for storing the input source, auto surround mode and input mode settings selected for the main zone and Zone2 in the memory so they can be used whenever desired.
- For Zone2, three patterns of settings can be stored in the memory using the USER MODE 1, 2 and 3 buttons on the Remote control unit.
- See page 146 for a description of the Main zone's "USER MODE" function.

■ Storing the settings in the memory



- 1** Set the following to the desired status:
- ① Zone2 input source
 - ② Zone2 auto surround mode
 - ③ Zone2 input mode

- 2**  Select the ZONE2 mode using the AMP/Z2 button.
(Remote control unit)

- 3**  Press and hold the USER MODE button at which you want to store the settings.
-  
- (Remote control unit)

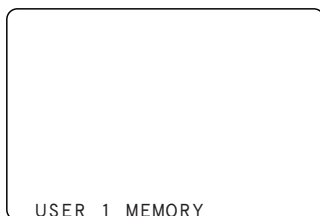

■ Calling the settings out

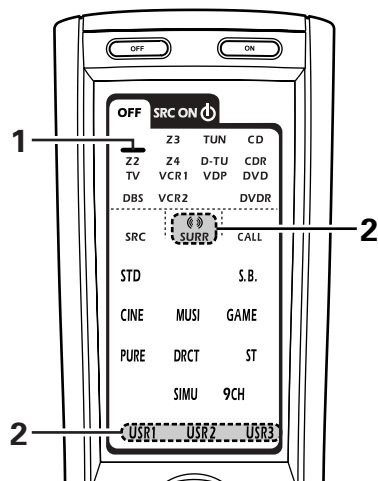

- 1**  Select the ZONE2 mode using the AMP/Z2 button.
(Remote control unit)

- 2**  Select the USER MODE button at which the settings you want to call out have been stored.

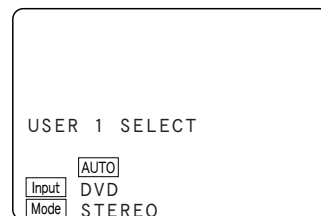
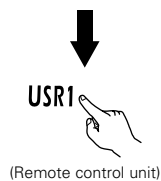

NOTE:

- When the setup lock function is activated, memory operation of the USER MODE button can not be performed.

Zone2 tone control setting

- This function allows you to adjust the bass and treble of the Zone2 audio output during surround playback in Zone2 to suit your tastes.

1 Select the ZONE2 mode using the AMP/Z2 button.

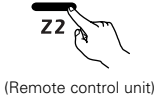

2 Press the SURROUND PARAMETER button.
Display the Surround Parameter Menu on the Zone2 monitor out.
※ The screen for the selected surround mode appears.

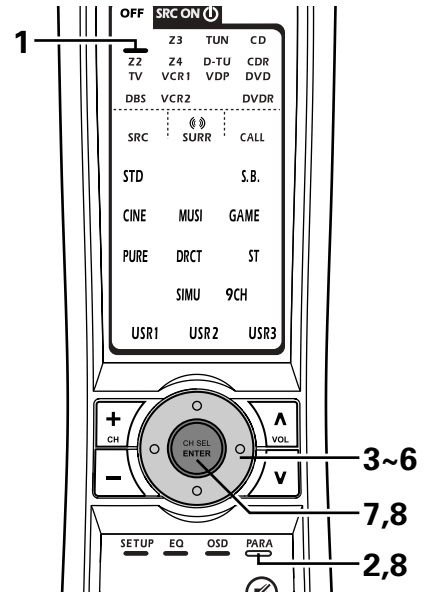
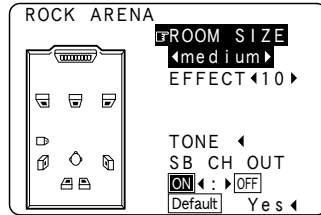
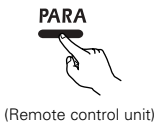

3 Select "TONE".

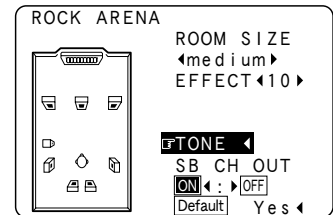
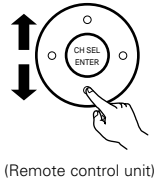

4 Display the Tone Control screen.

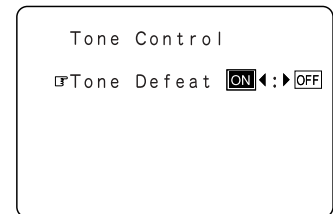
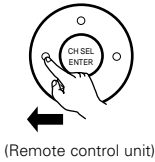

5 Display the Tone Control screen.
Select Tone Defeat OFF.

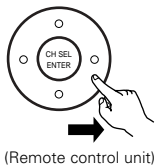

- ※ If you do not want the tone to be adjusted, set "Tone Defeat" to "ON".

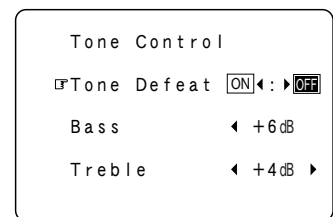

6 ① Select Bass or Treble.

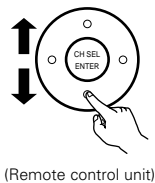

② Select the level.

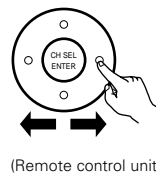

7 Enter the setting.
The Surround Parameter Menu screen re-appears.

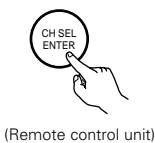

8

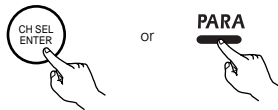

(Remote control unit)

If the setting ends, press the ENTER or SURROUND PARAMETER button again.

13 LISTENING TO THE RADIO

- Check that the Remote control unit is set to AMP or TUNER.

Auto tuning

- 1 Set the input source to "TUNER".

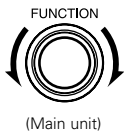

- 2 Select the TUNER mode using the TUN/D-TU button.



Select the TUNER mode using the TUN/D-TU button.

- 3 Watching the display, press the BAND button to select the desired band (AM or FM).



- 4 Press the MODE button to set the auto tuning mode.
- "Auto" appears on the display.



- 5 Press the TUNING + or - button.
- Automatic searching begins, then stops when a station is tuned in.

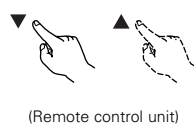
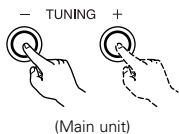

※ If tuning does not stop at the desired station, use to the "Manual tuning" operation.

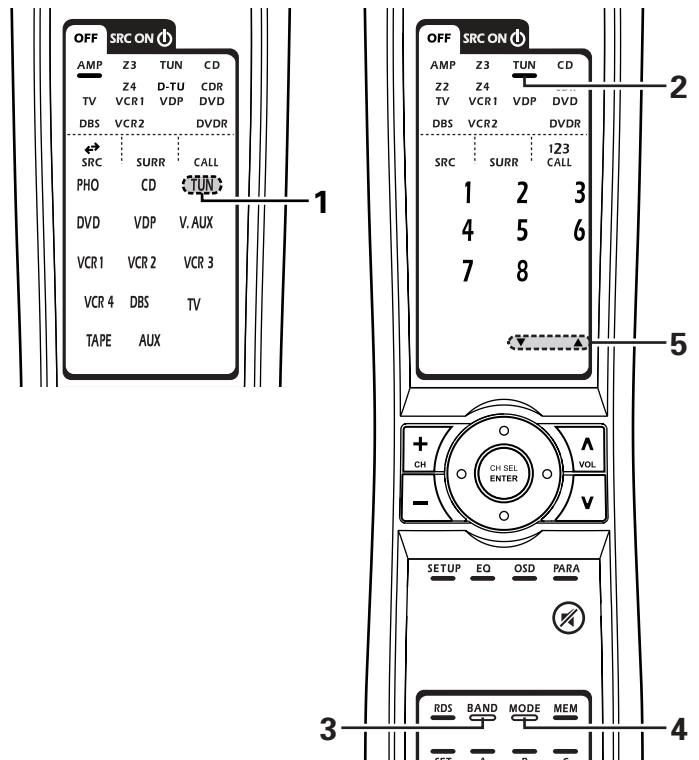
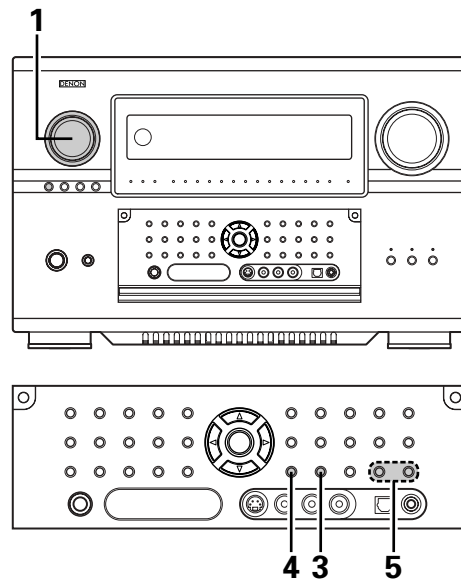

Manual tuning

- 1** Set the input source to "TUNER".

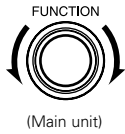

(Main unit)



(Remote control unit)

- 2** Select the TUNER mode using the TUN/D-TU button.



(Remote control unit)

- 3** Watching the display, press the BAND button to select the desired band (AM or FM).



(Main unit)



(Remote control unit)

- 4** Press the MODE button to set the manual tuning mode. Check that the display's "AUTO" indicator turns off.



(Main unit)



(Remote control unit)

- 5** Press the TUNING + or – button to tune in the desired station. The frequency changes continuously when the button is held in.

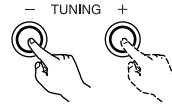

(Main unit)



(Remote control unit)

NOTES:

- When in the auto tuning mode on the FM band, the "STEREO" indicator lights on the display when a stereo broadcast is tuned in. At open frequencies, the noise is muted and the "TUNED" and "STEREO" indicators turn off.
- When the manual tuning mode is set, FM stereo broadcasts are received in monaural and the "STEREO" indicator turns off.

Preset memory

1 Use the "Auto tuning" or "Manual tuning" operation to tune in the station to be preset in the memory.

2  Select the TUNER mode using the TUN/D-TU button.
(Remote control unit)

3 Press the MEMORY button.



4  Press the memory block (A to G) button.

(Remote control unit)



(Remote control unit)

※ The memory block can also be selected by pressing the SHIFT button.

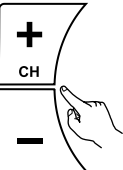
5  Press the CHANNEL + (UP) or - (DOWN) button to select the desired preset channel (1 to 8).

(Remote control unit)

6 Press the MEMORY button again to store the station in the preset memory.

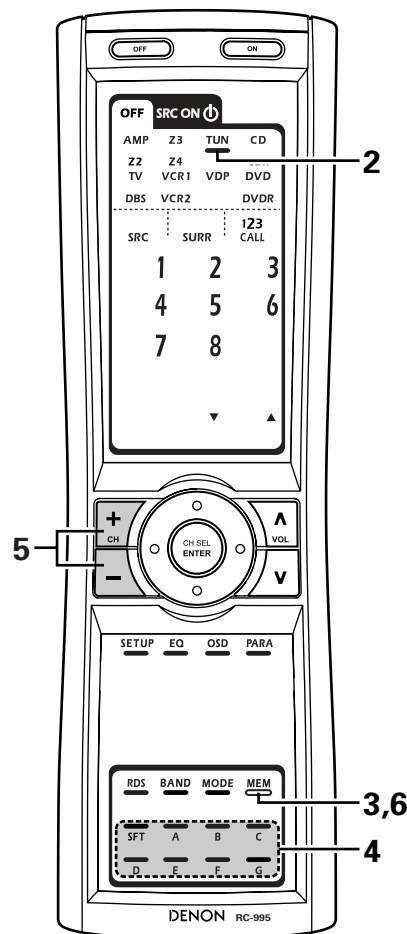
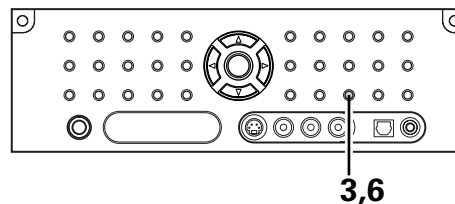

※ To preset other channels, repeat steps 2 to 5.
A total of 56 broadcast stations can be preset — 8 stations (channels 1 to 8) in each of blocks A to G.

Checking the preset stations

- The preset (broadcast) stations can be checked on the on screen display.

- Press the ON SCREEN button on the Remote control unit repeatedly until the "Tuner Preset Stations" screen appears on the OSD.

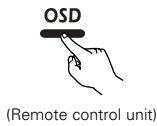

Tuner Preset Stations	
A1FM	87.50MHz
A2FM	89.10MHz
A3FM	98.10MHz
A4FM	107.90MHz
A5FM	90.10MHz
A6FM	90.10MHz
A7FM	90.10MHz
A8FM	90.10MHz

OSD-8

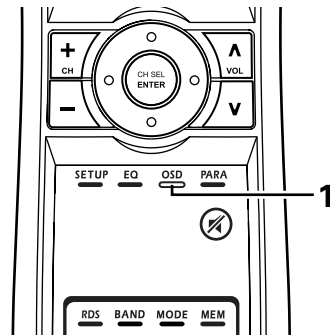

Recalling preset stations

- Recalling preset stations from the Remote control unit.
- Preset stations can be chosen directly preset channel and channel range button. (see page 115)

- Select the preset memory block.

(Remote control unit)

- Watching the display, press the CHANNEL + (UP) or - (DOWN) button to select the desired preset channel.

(Remote control unit)

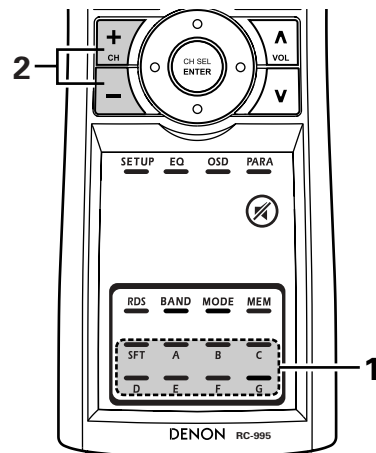

- Recalling preset stations from the Main unit's panel.

- Press the TUNING PRESET button.

(Main unit)

- Turn the FUNCTION knob and select the desired preset channel.

(Main unit)

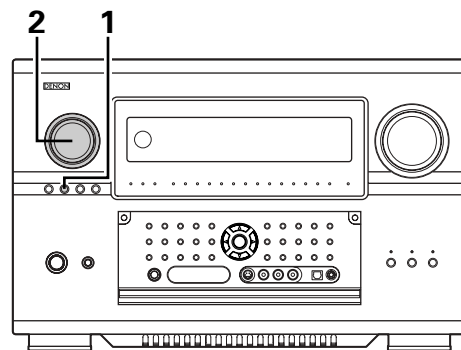

RDS (Radio Data System)

RDS (works only on the FM band) is a broadcasting service which allows station to send additional information along with the regular radio program signal.

The following three types of RDS information can be received on this unit:

■ Program Type (PTY)

PTY identifies the type of RDS program.

The program types and their displays are as follows:

R1 AM 87.50MHz PTY NEWS

NEWS
INFORM
SPORTS
TALK
ROCK
CLS ROCK
ADLT HIT
SOFT RCK

News
Information
Sports
Talk
Rock
Classic rock
Adult hits
Soft rock

TOP 40
COUNTRY
OLDIES
SOFT
NOSTALGA
JAZZ
CLASSICL
R & B

Top 40
Country
Oldies
Soft
Nostalgia
Jazz
Classical
R & B

SOFT R&B
LANGUAGE
REL MUSC
REL TALK
PERSNLTY
PUBLIC
COLLEGE
WEATHER

Soft R&B
Language
Religious music
Religious talk
Personality
Public
College
Weather

■ Traffic Program (TP)

TP identifies programs that carry traffic announcements.

This allows you to easily find out the latest traffic conditions in your area before you leaving home.

■ Radio Text (RT)

RT allows the RDS station to send text messages that appear on the display.

NOTE: The operations described below using the RDS button will not function in areas in which there are no RDS broadcasts.

RDS search

Use this function to automatically tune to FM stations that provide RDS service.



Set the input source to "TUNER".

(Remote control unit)



Press the RDS button until "RDS SEARCH" appears on the display.

(Remote control unit)

※ The Main unit's display switches as follows each time the RDS buttons are pressed.

Display

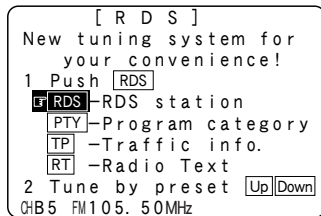

This is the screen when operated.

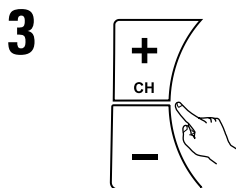

Press the CHANNEL + (UP) or - (DOWN) button to automatically begin the RDS search operation.

If no RDS stations is found with above operation, all the reception band are searched.

(Remote control unit)

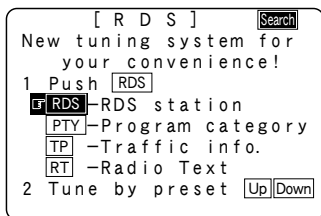

4 When a broadcast station is found, that station's name appears on the display.

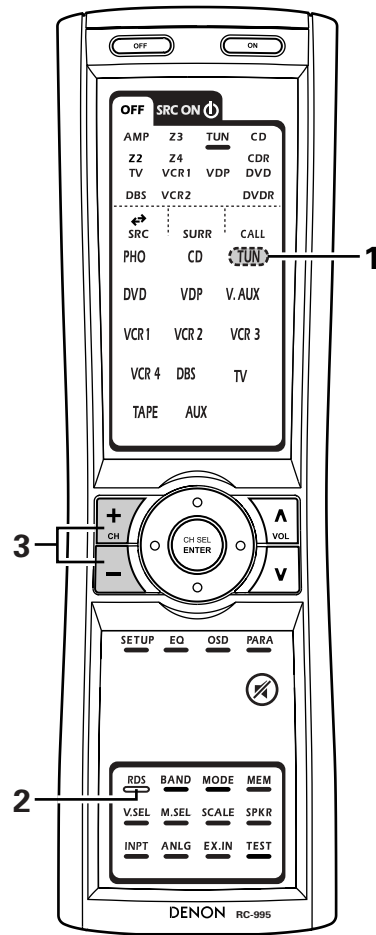

5 To continue searching, repeat step 3. If no other RDS station is found when all the frequencies are searched, "NO RDS" is displayed.

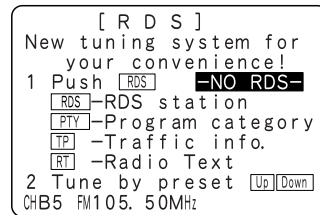

This is the screen when operated.

PTY search

Use this function to find RDS stations broadcasting a designated program type (PTY).
For a description of each program type, refer to "Program Type (PTY)".

- 1** Set the input source to "TUNER".

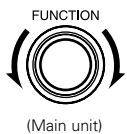

- 2** Press the RDS button until "PTY SEARCH" appears on the display.



(Remote control unit)

※ The Main unit's display switches as follows each time the RDS buttons are pressed.

Display

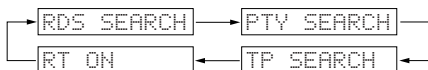

- 3** Watching the display, press the Cursor left and right buttons to call out the desired program type.

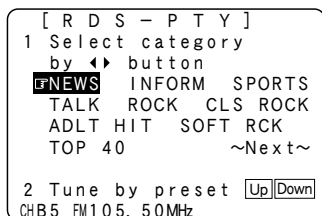
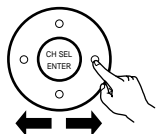
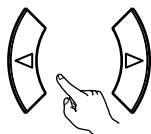

- 4** Press the CHANNEL + (UP) or - (DOWN) button to automatically begin the PTY search operation.

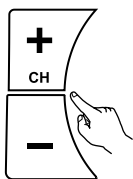

If there is no station broadcasting the designated program type with above operation, all the reception bands are searched.

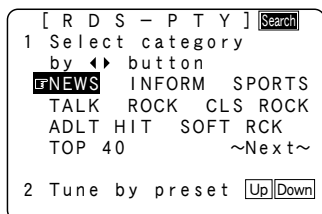

- 5** The station name is displayed on the display after searching stops.

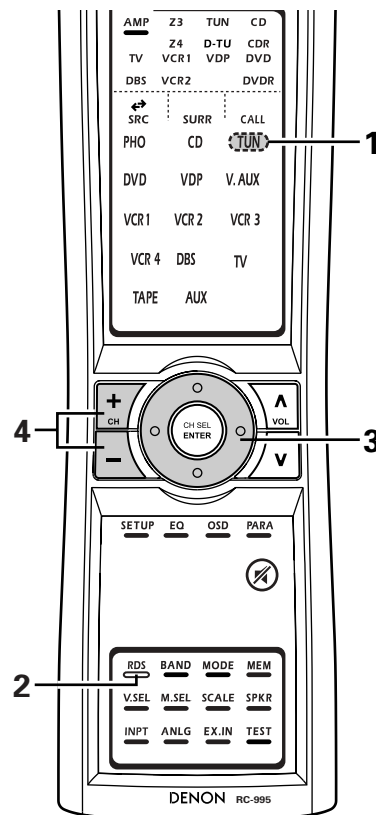
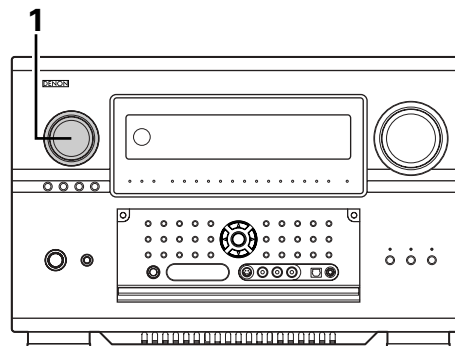

- 6** To continue searching, repeat step 4.
If no other station broadcasting the designated program type is found when all the frequencies are searched, "NO PROGRAMME" is displayed.

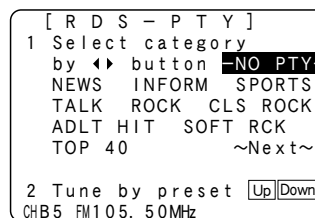

This is the screen when operated.

TP search

Use this function to find RDS stations broadcasting traffic program (TP stations).

- 1** Set the input source to "TUNER".

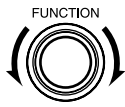

(Main unit)



(Remote control unit)

- 2** Press the RDS button until "TP SEARCH" appears on the display.



(Remote control unit)

※ The Main unit's display switches as follows each time the RDS buttons are pressed.

Display

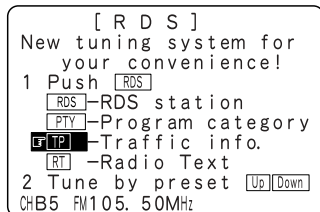

This is the screen when operated.

- 3** Press the CHANNEL + (UP) or - (DOWN) button TP search begins.

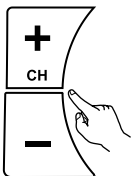

(Remote control unit)

If no TP station is found with above operation, all the reception bands are searched.

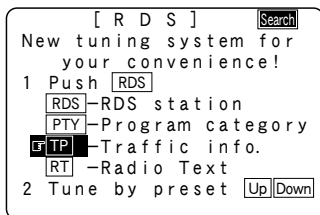

- 4** The station name is displayed on the display after searching stops.

- 5** To continue searching, repeat step 3.
If no other TP station is found when all the frequencies are searched, "NO PROGRAMME" is displayed.

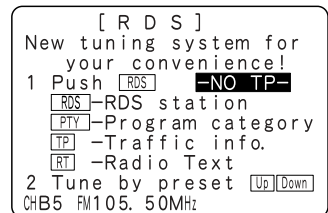

This is the screen when operated.

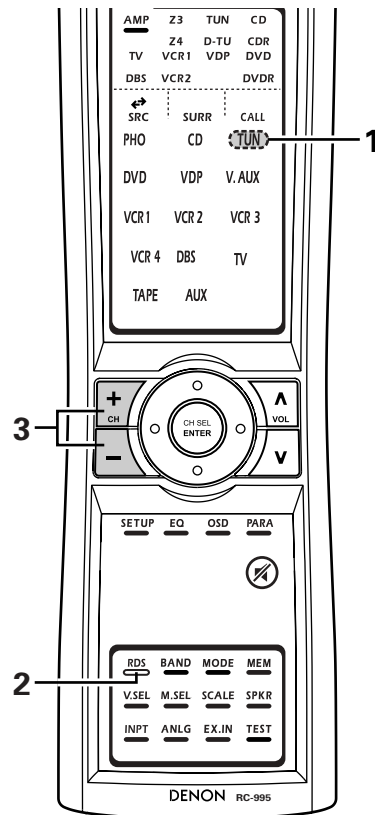
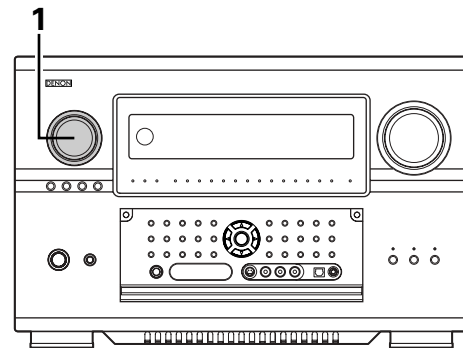

RT (Radio Text)

"RT" appears on the display when radio text data is received. When the RDS button is pressed until "RT" appears on the display while receiving an RDS broadcast station, the text data broadcast from the station is displayed. To turn the display off, use the left and right cursor buttons on the Remote control unit. If no text data is being broadcast, "NO TEXT DATA" is displayed.

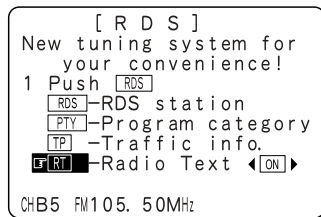

This is the screen when operated.

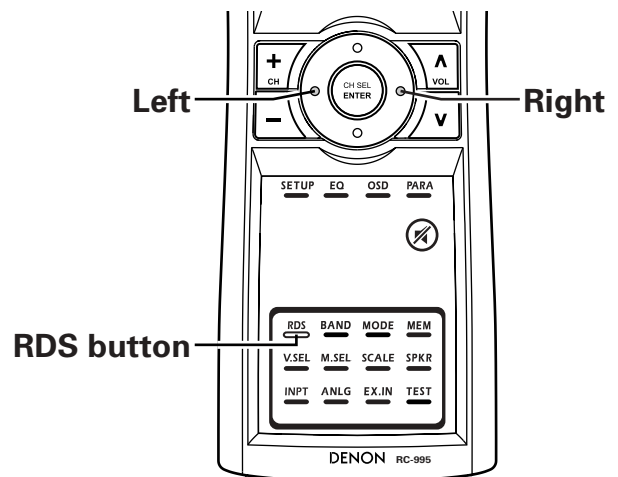

14 LAST FUNCTION MEMORY

- This unit is equipped with a last function memory which stores the input and output setting conditions as they were immediately before the power is switched off. This function eliminates the need to perform complicated resetting when the power is switched on.
- The unit is also equipped with a back-up memory. This function provides approximately one week of memory storage from when the Main unit's power switch is off and with the power cord disconnected.

15 INITIALIZATION OF THE MICROPROCESSOR

In very rare instances, the AVR-5805 internal microprocessor might lock up, or otherwise cause mis-operation. This might be caused due to an AC line surge or line spike noise, or by static electric discharge on or nearby the unit, or to connected components. If the condition cannot be corrected by powering off the unit, including disconnection of the AC cord for a period of ten minutes and subsequent re-connection, then the unit may have to be re-initialized. Doing so will restore the microprocessor to its original out-of-the-box state, with all custom memories and settings erased, and the original factory default settings restored. Only use this procedure if you are sure that the microprocessor requires re-initialization.

- 1 Switch off the unit using the Main unit's power operation switch.
- 2 Hold the following STANDARD button and HOME THX CINEMA button, and turn the Main unit's power operation switch on.
- 3 Check that the entire display is flashing with an interval of about 1 second, and release your fingers from the 2 buttons and the microprocessor will be initialized.

NOTES:

- If step 3 does not work, start over from step 1.
- If the microprocessor has been reset, all the settings are reset to the default values (the values set upon shipment from the factory).

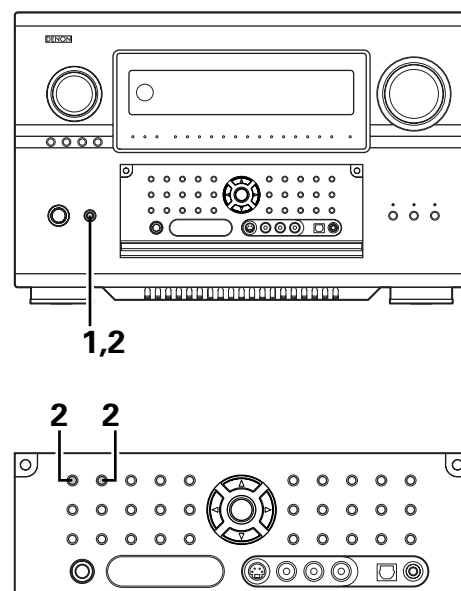

16 TROUBLESHOOTING

If a problem should arise, first check the following.

1. Are the connections correct?
2. Have you operated the receiver according to the Operating Instructions?
3. Are the speakers, and other connected components operating properly?

If this unit is not operating properly, check the items listed in the table below. Should the problem persist, there may be a malfunction. Disconnect the power immediately and contact your store of purchase.

Symptom	Cause	Measures	Page
DISPLAY not lit and sound not produced when power switch set to on.	<ul style="list-style-type: none"> Power cord not plugged in securely. 	<ul style="list-style-type: none"> Check the insertion of the power cord plug. 	10
DISPLAY lit but sound not produced.	<ul style="list-style-type: none"> Speaker cords not securely connected. FUNCTION knob position is not appropriate. Volume control set to minimum. MUTING is on. No digital signal is being input. 	<ul style="list-style-type: none"> Connect securely. Switch to the proper position. Turn volume up to suitable level. Switch off MUTING. Properly select a digital signal input source. 	20, 21 126 127 130 58
Nothing is displayed on monitor.	<ul style="list-style-type: none"> AVR-5805's video output jacks and monitor's input jacks are not properly connected. Monitor TV's input setting is wrong. The VIDEO OFF mode is set. The PURE DIRECT mode is set. The resolution of the monitor device connected to the component monitor output connector does not match the AVR-5805's resolution. 	<ul style="list-style-type: none"> Check that the connections are correct. Set the TV's input selector to the jacks to which video signals are connected. Set the VIDEO ON mode. Set a surround mode other than the PURE DIRECT mode. Use the SCALE button on the main unit or the remote control unit to check the resolution setting. 	11~15 — 129 129 132
No DTS sound is produced.	<ul style="list-style-type: none"> DVD player's audio output setting is not set to bit stream. DVD player is not DTS-compatible. AVR-5805's input setting is set to analog. 	<ul style="list-style-type: none"> Make the DVD player's initial settings. Use a DTS-compatible player. Set to AUTO or DTS. 	— — 126
Ultra2 Cinema / THX Music Mode / THX Games Mode cannot be set.	<ul style="list-style-type: none"> Surround back speaker set to 1. 	<ul style="list-style-type: none"> Connect two surround back speakers. 	29, 46, 47, 57
Copying from DVD to VCR is not possible.	<ul style="list-style-type: none"> Copying between a source such as DVD and a VCR is not usually possible, as DVDs are often encoded with copy-protection signals that prevent VCR recording. 	<ul style="list-style-type: none"> Copying is not possible. 	—
No sound is produced from subwoofer.	<ul style="list-style-type: none"> Subwoofer's power is not on. Subwoofer's initial setting is set to "NO". Subwoofer's output is not connected. 	<ul style="list-style-type: none"> Turn on the power. Set the setting to "YES". Connect properly. 	— 46, 47 21, 99, 100
No test tones are produced.	<ul style="list-style-type: none"> Surround mode is set to a mode other than Dolby Surround. 	<ul style="list-style-type: none"> Set to Dolby Surround. 	—
No sound is produced from surround speakers.	<ul style="list-style-type: none"> Surround mode is set to "STEREO". 	<ul style="list-style-type: none"> Set to a mode other than "STEREO". 	—
This unit does not operate properly when Remote control unit is used.	<ul style="list-style-type: none"> Batteries dead. Remote control unit too far from this unit. Obstacle between this unit and Remote control unit. Different button is being pressed. ⊕ and ⊖ ends of battery inserted in reverse. 	<ul style="list-style-type: none"> Replace with new batteries. Move closer. Remove obstacle. Press the proper button. Insert batteries properly. 	113 113 113 — 113
An image is not projected with an HDMI/DVI-D connection.	<ul style="list-style-type: none"> AVR-5805's HDMI/DVI-D output jacks and monitor's input jacks are not properly connected. No HDMI/DVI-D signal is being input. The connected monitor equipment or other equipments do not support HDCP. The settings of "MONITOR SELECT" is not appropriate. The output format of the connected player (HDMI/DVI-D FORMAT) does not match the supported input format of connected monitor equipments. 	<ul style="list-style-type: none"> Check the HDMI/DVI-D connection. Properly select HDMI or DVI-D signal input source. The AVR-5805 will not output video signal unless the other equipment supports HDCP. Check the settings of "MONITOR SELECT". Check whether the output format of the connected player (HDMI/DVI-D FORMAT) matches the supported input format of connected monitor equipments. 	14, 15 75, 76 14, 15 75, 76, 131 75, 76
The HDMI audio is not output.	<ul style="list-style-type: none"> The AVR-5805 does not play HDMI audio signals. The HDMI audio signals are not output from the connected monitor device. 	<ul style="list-style-type: none"> Set the HDMI audio playback setting at the "HDMI/DVI In Assign" settings to "AMP". Set the HDMI audio playback setting at the "HDMI/DVI In Assign" settings to "TV". 	75, 76 75, 76

17 ADDITIONAL INFORMATION

Optimum surround sound for different sources

There are currently various types of multi-channel signals (signals or formats with more than two channels).

■ Types of multi-channel signals

Dolby Digital (including Surround EX), DTS (including Surround ES), DVD-Audio, and SACD (Super Audio CD).

Note on the above: MUSE 3.1 and MPEG multi-channel audio are not available to North American consumers – same is true for Dolby's AAC.

“Source” here does not refer to the type of signal (format) but the recorded content. Sources can be divided into two major categories.

2 Types of sources

• Movie audio

Signals created to be played in movie theaters. In general sound is recorded to be played in movie theaters equipped with multiple surround speakers, regardless of the format (Dolby Digital, DTS, etc.).

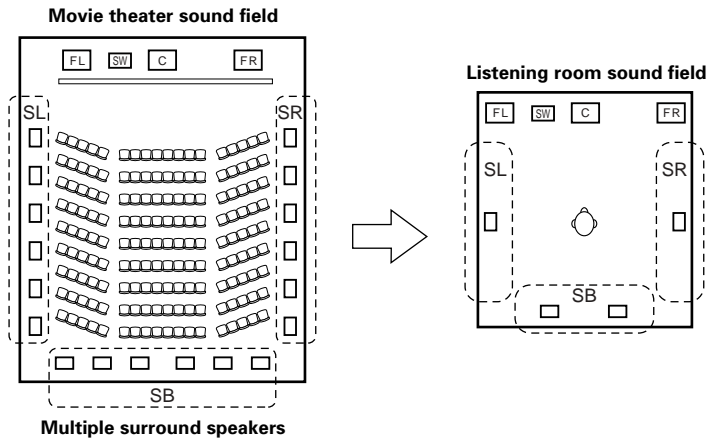

In this case it is important to achieve the same sense of expansion as in a movie theater with the surround channels. To do so, in some cases the number of surround speakers is increased (to four or eight) or speakers with bipolar or dipolar properties are used.

(SL: Surround L channel
SR: Surround R channel
SB: Surround B (back) channel

- **Other types of audio** These signals are designed to recreate a 360° sound field using three to five speakers.

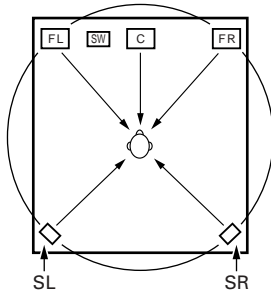

In this case the speakers should surround the listener from all sides to create a uniform sound field from 360°. Ideally the surround speakers should function as “point” sound sources in the same way as the front speakers.

These two types of sources thus have different properties, and different speaker settings, particularly for the surround speakers, are required in order to achieve the ideal sound.

The AVR-5805's surround speaker selection function makes it possible to change the settings according to the combination of surround speakers being used and the surrounding environment in order to achieve the ideal surround sound for all sources. This means that you can connect a pair of bipolar or dipolar surround speakers (mounted on either side of the prime listening position), as well as a separate pair of direct radiating (monopolar) speakers placed at the rear corners of the listening room.

Surround back speakers

The THX Surround EX format adds new "Surround Back" (SB) channels to the conventional 5.1-channel system. This makes it easy to achieve sound positioned directly behind the listener, something that was previously difficult with sources designed for conventional multi surround speakers. In addition, the acoustic image extending between the sides and the rear is narrowed, thus greatly improving the expression of the surround signals for sounds moving from the sides to the back and from the front to the point directly behind the listening position.

Change of positioning and acoustic image with 5.1-channel systems

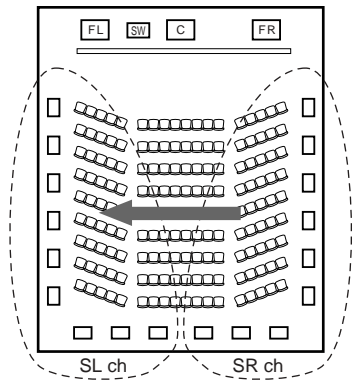

Movement of acoustic image from SR to SL

Change of positioning and acoustic image with THX Surround EX system

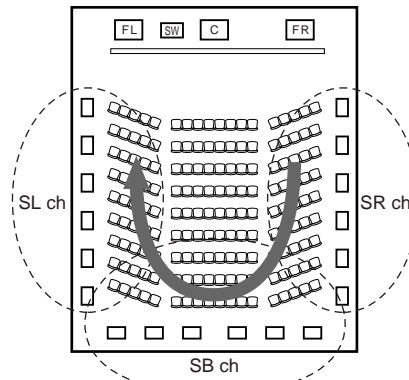

Movement of acoustic image from SR to SB to SL

Speaker(s) for one or two channels are required in order to achieve a THX Surround EX system with the AVR-5805. Adding these, however, allows you to achieve stronger surround effects not only with sources recorded in THX Surround EX, but also with conventional 2- to 5.1-channel sources. The WIDE SCREEN mode is a mode for achieving surround sound with up to 7.1 channels using surround back speakers, for sources recorded in conventional Dolby Surround as well as Dolby Digital 5.1-channel and DTS Surround 5.1-channel sources. Furthermore, all the Denon original surround modes (see page 147) are compatible with 7.1-channel playback, so you can enjoy 7.1-channel sound with any signal source.

■ Number of surround back speakers

With THX Surround EX, the surround back channel consists of one channel of playback signals, but we recommend using two speakers. When using dipolar speakers in particular, it is essential to use two speakers.

Using two speakers results in a smoother blend with the sound of the surround channels and better sound positioning of the surround back channel when listening from a position other than the center.

■ Placement of the surround left and right channels when using surround back speakers

Using surround back speakers greatly improves the positioning of the sound at the rear. Because of this, the surround left and right channels play an important role in achieving a smooth transition of the acoustic image from the front to the back. As shown on the diagram above, in a movie theater the surround signals are also produced from diagonally in front of the listeners, creating an acoustic image as if the sound were floating in space.

To achieve these effects, we recommend placing the speakers for the surround left and right channels slightly more towards the front than with conventional surround systems. Doing so sometimes increases the surround effect when playing conventional 5.1-channel sources in the THX Surround EX mode. Check the surround effects of the various modes before selecting the surround mode.

Speaker setting examples

Here we describe a number of speaker settings for different purposes. Use these examples as guides to set up your system according to the type of speakers used and the main usage purpose.

[1] For THX Surround EX systems (using surround back speakers)

① Basic setting for primarily watching movies

This is recommended when mainly playing movies and using regular single way or 2-way speakers for the surround speakers.

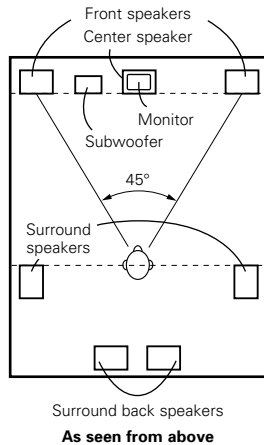

- Set the front speakers with their front surfaces as flush with the TV or monitor screen as possible. Set the center speaker between the front left and right speakers and no further from the listening position than the front speakers.
- Consult the owner's manual for your subwoofer for advice on placing the subwoofer within the listening room.
- If the surround speakers are direct-radiating (monopolar) then place them slightly behind and at an angle to the listening position and parallel to the walls at a position 60 to 90 centimeters (2 to 3 feet) above ear level at the prime listening position.
- When using two surround back speakers, set them at the back facing front and with both speakers at the same distance from the listening point. When using one surround back speaker, place it at the rear center facing the front at a slightly higher position (0 to 20 cm) than the surround speakers.
- We recommend installing the surround back speaker(s) at a slightly downward facing angle. This effectively prevents the surround back channel signals from reflecting off the monitor or screen at the front center, resulting in interference and making the sense of movement from the front to the back less sharp.
- Connect the surround speakers to the surround speaker A jacks on the AVR-5805 and set settings on the setup menu to "A". (This is the factory default setting. For details, see page 27.)

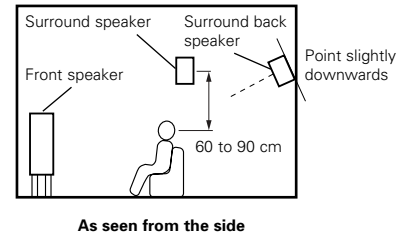

② Setting for primarily watching movies using diffusion type speakers for the surround speakers

For the greatest sense of surround sound envelopment, diffuse radiation speakers such as bipolar types, or dipolar (THX) types, provide a wider dispersion than is possible to obtain from a direct radiating speaker (monopolar). Place these speakers at either side of the prime listening position, mounted above ear level.

Path of the surround sound from the speakers to the listening position

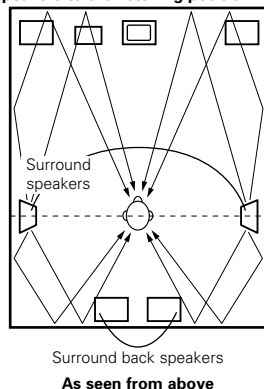

- Set the front speakers, center speaker and subwoofer in the same positions as in example (1).
- It is best to place the surround speakers directly at the side or slightly to the front of the viewing position, and 60 to 90 cm above the ears.
- Same as surround back speaker installation method (1).
- Connect the surround speakers to the surround speaker A jacks on the AVR-5805 and set settings on the setup menu to "A". (This is the factory default setting. For details, see page 27.)
- The signals from the surround channels reflect off the walls as shown on the diagram at the left, creating an enveloping and realistic surround sound presentation. For multi-channel music sources however, the use of bipolar or dipolar speakers mounted at the sides of the listening position may not be satisfactory in order to create a coherent 360 degree surround sound field. Connect another pair of direct radiating speakers as described in example (3) and place them at the rear corners of the room facing towards the prime listening position.

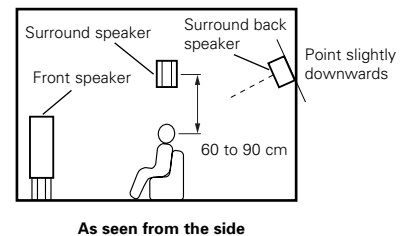

③ **When using different surround speakers for movies and music**

To achieve more effective surround sound for both movies and music, use different sets of surround speakers and different surround modes for the two types of sources.

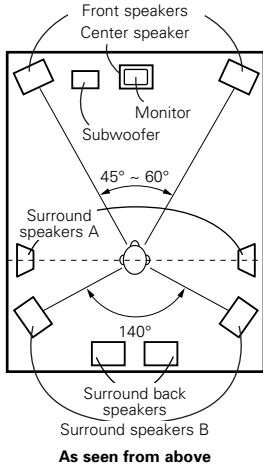

- Set the front speakers slightly wider apart than the setup for watching movies only and point them toward the listening position in order assure clear positioning of the sound.
- Set the center speaker in the same positions as in example (1).
- Set surround speakers A for watching movies in the positions described in example (1) or (2), depending on the types of speakers used.
- Set surround speakers B for playing multi-channel music at the same height as the front speakers and slightly at an angle to the rear of the listening position, and point them toward the listening position.
- Connect the surround speakers for watching movies to the surround speaker A jacks on the AVR-5805, the surround speakers for playing multi-channel music to the surround speaker B jacks. Set the surround speaker selection on the setup menu. (For instructions, see page 55.)
- To activate the appropriate speakers for movies and music, we suggest that during setup, choose Dolby Digital/DTS with THX and Surround Speakers A (the bipolar or dipolar speakers mounted at the sides of the listening position).

Choose Dolby Digital/DTS without THX and Surround Speakers B (the direct radiating speakers mounted at the rear corners of the listening room). Then, by simply activating the THX function (used during movie playback, the Surround A speakers are automatically activated. For multi-channel music listening (Dolby Digital or DTS music programs), turn off the THX enhancements by touching the THX button on the remote control, and the Surround B speakers will be automatically activated.

Example: Movie sources (Dolby, DTS surround, etc.)
 "THX" or "THX 5.1" mode: Speakers A
 Music sources (DVD video, DTS CD, etc.)
 "Dolby/DTS surround": Speakers B

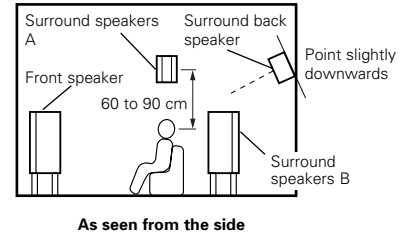

※ The speakers can be switched at the touch of a button by turning HOME THX CINEMA on when playing movies and off when playing multi-channel music.

[2] **When not using surround back speakers**

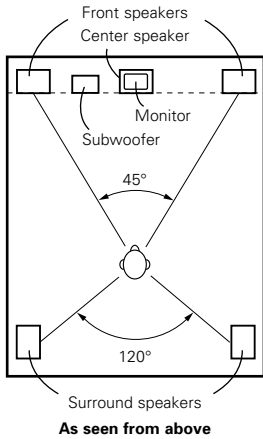

- Set the front speakers with their front surfaces as flush with the TV or monitor screen as possible. Set the center speaker between the front left and right speakers and no further from the listening position than the front speakers.
- Consult the owner's manual for your subwoofer for advice on placing the subwoofer within the listening room.
- If the surround speakers are direct-radiating (monopolar) then place them slightly behind and at an angle to the listening position and parallel to the walls at a position 60 to 90 centimeters (2 to 3 feet) above ear level at the prime listening position.
- Connect the surround speakers to the surround speaker A jacks on the AVR-5805 and set settings on the setup menu to "A". (This is the factory default setting. For details, see page 27.)

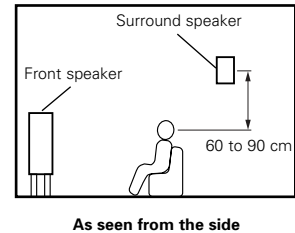

The surround speakers can be switched freely during playback with the surround parameter adjustment. (For instructions, see page 131.)

Surround

The AVR-5805 is equipped with a digital signal processing circuit that lets you play program sources in the surround mode to achieve the same sense of presence as in a movie theater.

[1] Dolby Surround

① Dolby Digital

Dolby Digital is the multi-channel digital signal format developed by Dolby Laboratories.

Dolby Digital consists of up to "5.1" channels - front left, front right, center, surround left, surround right, and an additional channel exclusively reserved for additional deep bass sound effects (the Low Frequency Effects – LFE – channel, also called the ".1" channel, containing bass frequencies of up to 120 Hz).

Unlike the analog Dolby Pro Logic format, Dolby Digital's main channels can all contain full range sound information, from the lowest bass, up to the highest frequencies – 22 kHz. The signals within each channel are distinct from the others, allowing pinpoint sound imaging, and Dolby Digital offers tremendous dynamic range from the most powerful sound effects to the quietest, softest sounds, free from noise and distortion.

■ Dolby Digital and Dolby Pro Logic

Comparison of home surround systems	Dolby Digital	Dolby Pro Logic
No. recorded channels (elements)	5.1 ch	2 ch
No. playback channels	5.1 ch	4 ch
Playback channels (max.)	L, R, C, SL, SR, SW	L, R, C, S (SW - recommended)
Audio processing	Digital discrete processing Dolby Digital (AC-3) encoding/decoding	Analog matrix processing Dolby Surround
High frequency playback limit of surround channel	20 kHz	7 kHz

■ Dolby Digital compatible media and playback methods

Marks indicating Dolby Digital compatibility:  .

The following are general examples. Also refer to the player's operating instructions.

Media	Dolby Digital output jacks	Playback method (reference page)
DVD	Optical or coaxial digital output (same as for PCM) ※ 1	Set the input mode to "AUTO". (Page 126)
Others (satellite broadcasts, CATV, etc.)	Optical or coaxial digital output (same as for PCM)	Set the input mode to "AUTO". (Page 126)

※ 1 Some DVD digital outputs have the function of switching the Dolby Digital signal output method between "bit stream" and "(convert to) PCM". When playing in Dolby Digital surround on the AVR-5805, switch the DVD player's output mode to "bit stream". In some cases players are equipped with both "bit stream + PCM" and "PCM only" digital outputs. In this case connect the "bit stream + PCM" jacks to the AVR-5805.

② Dolby Pro Logic IIx

- Dolby Pro Logic IIx furthers the matrix decoding technology of Dolby Pro Logic II to decode audio signals recorded on two channels into up to 7.1 playback channels, including the surround back channel. Dolby Pro Logic IIx also allows 5.1-channel sources to be played in up to 7.1 channels.

The mode can be selected according to the source. The Music mode is best suited for playing music, the Cinema mode for playing movies, and the Game mode for playing games. The Game mode can only be used with 2-channel audio sources.

③ **Dolby Pro Logic II**

- Dolby Pro Logic II is a new multi-channel playback format developed by Dolby Laboratories using feedback logic steering technology and offering improvements over conventional Dolby Pro Logic circuits.
- Dolby Pro Logic II can be used to decode not only sources recorded in Dolby Surround (※) but also regular stereo sources into five channels (front left, front right, center, surround left and surround right) to achieve surround sound.
- Whereas with conventional Dolby Pro Logic the surround channel playback frequency band was limited, Dolby Pro Logic II offers a wider band range (20 Hz to 20 kHz or greater). In addition, the surround channels were monaural (the surround left and right channels were the same) with previous Dolby Pro Logic, but Dolby Pro Logic II they are played as stereo signals.
- Various parameters can be set according to the type of source and the contents, so it is possible to achieve optimum decoding (see page 143).

※ Sources recorded in Dolby Surround

These are sources in which three or more channels of surround have been recorded as two channels of signals using Dolby Surround encoding technology.

Dolby Surround is used for the sound tracks of movies recorded on DVDs, LDs and video cassettes to be played on stereo VCRs, as well as for the stereo broadcast signals of FM radio, TV, satellite broadcasts and cable TV.

Decoding these signals with Dolby Pro Logic makes it possible to achieve multi-channel surround playback. The signals can also be played on ordinary stereo equipment, in which case they provide normal stereo sound.

There are two types of DVD Dolby surround recording signals.

- ① 2-channel PCM stereo signals
- ② 2-channel Dolby Digital signals

■ **Sources recorded in Dolby Surround are indicated with the logo mark shown below.**

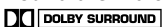
Dolby Surround support mark: 

Manufactured under license from Dolby Laboratories. "Dolby", "Pro Logic", "Surround EX" and the double-D symbol are trademarks of Dolby Laboratories.

④ **Dolby Headphone**

- This is a three-dimensional sound technology developed jointly by Dolby Laboratories and Lake Technology Ltd. of Australia for achieving surround sound using regular headphones.
- Previously, when using headphones all the sounds resonated inside the head and it was uncomfortable to listen with headphones for long periods of time. Dolby Headphone simulates speaker playback in a room and places the sound at the front or the sides, outside the head, to achieve a powerful sound like the sound of movie or home theaters. This technology is mainly for multichannel audio/video equipment with Dolby Digital or Dolby Pro Logic Surround decoding functions and works with a high performance digital signal processing (DSP) chip.
- Dolby Headphone is effective not only for multichannel sources but also for stereo programs.
- On the AVR-5805, it is possible to output signals encoded in the Dolby Headphone mode from the recording output terminal and record them on a separate recorder.

[2] **DTS Digital Surround**

DTS Digital Surround (also called simply DTS) is a multi-channel digital signal format developed by Digital Theater Systems. DTS offers the same "5.1" playback channels as Dolby Digital (front left, front right and center, surround left and surround right) as well as the stereo 2-channel mode. The signals for the different channels are fully independent, eliminating the risk of deterioration of sound quality due to interference between signals, crosstalk, etc.



DTS features a relatively higher bit rate as compared to Dolby Digital (1234 kbps for CDs and LDs, 1536 kbps for DVDs) so it operates with a relatively low compression rate. Because of this the amount of data is great, and when DTS playback is used in movie theaters, a separate CD-ROM synchronized with the film is played.

With LDs and DVDs, there is of course no need for an extra disc; the pictures and sound can be recorded simultaneously on the same disc, so the discs can be handled in the same way as discs with other formats.

There are also music CDs recorded in DTS. These CDs include 5.1-channel surround signals (compared to two channels on current CDs). They do not include picture data, but they offer surround playback on CD players that are equipped with digital outputs (PCM type digital output required).

DTS surround track playback offers the same intricate, grand sound as in a movie theater, right in your own listening room.

■ **DTS compatible media and playback methods**

Marks indicating DTS compatibility:  and .

The following are general examples. Also refer to the player's operating instructions.

Media	DTS Digital output jacks	Playback method (reference page)
CD	Optical or coaxial digital output (same as for PCM) ※ 2	Set the input mode to "AUTO" or "DTS" (page 126). Never set the mode to "ANALOG" or "PCM". ※ 1
DVD	Optical or coaxial digital output (same as for PCM) ※ 3	Set the input mode to "AUTO" or "DTS" (page 126).

- ※ 1 DTS signals are recorded in the same way on CDs and LDs as PCM signals. Because of this, the un-decoded DTS signals are output as random “hissy” noise from the CD or LD player’s analog outputs. If this noise is played with the amplifier set at a very high volume, it may possibly cause damage to the speakers. To avoid this, be sure to switch the input mode to “AUTO” or “DTS” before playing CDs or LDs recorded in DTS. Also, never switch the input mode to “ANALOG” or “PCM” during playback. The same holds true when playing CDs or LDs on a DVD player or LD/DVD compatible player. For DVDs, the DTS signals are recorded in a special way so this problem does not occur.
- ※ 2 The signals provided at the digital outputs of a CD or LD player may undergo some sort of internal signal processing (output level adjustment, sampling frequency conversion, etc.). In this case the DTS-encoded signals may be processed erroneously, in which case they cannot be decoded by the AVR-5805, or may only produce noise. Before playing DTS signals for the first time, turn down the master volume to a low level, start playing the DTS disc, then check whether the DTS indicator on the AVR-5805 (see page 140) lights before turning up the master volume.
- ※ 3 A DVD player with DTS-compatible digital output is required to play DTS DVDs. A DTS Digital Output logo is featured on the front panel of compatible DVD players. Recent DENON DVD player models feature DTS-compatible digital output – consult the player’s owner’s manual for information on configuring the digital output for DTS playback of DTS-encoded DVDs.

MANUFACTURED UNDER LICENSE FROM DIGITAL THEATER SYSTEMS, INC.
 U.S. PAT. NO’S. 5,451,942; 5,956,674; 5,974,380; 5,978,762; 6,226,616; 6,487,535 AND OTHER U.S. AND WORLD-WIDE PATENTS ISSUED AND PENDING.
 “DTS”, “DTS-ES”, “Neo:6”, AND “DTS 96/24” ARE TRADEMARKS OF DIGITAL THEATER SYSTEMS, INC. © 1996, 2003 DIGITAL THEATER SYSTEMS, INC. ALL RIGHTS RESERVED.

[3] DTS-ES Extended Surround™

DTS-ES Extended Surround is a new multi-channel digital signal format developed by Digital Theater Systems Inc. While offering high compatibility with the conventional DTS Digital Surround format, DTS-ES Extended Surround greatly improves the 360-degree surround impression and space expression thanks to further expanded surround signals. This format has been used professionally in movie theaters since 1999.

In addition to the 5.1 surround channels (FL, FR, C, SL, SR and LFE), DTS-ES Extended Surround also offers the SB (Surround Back, sometimes also referred to as “surround center”) channel for surround playback with a total of 6.1 channels. DTS-ES Extended Surround includes two signal formats with different surround signal recording methods, as described below.

■ DTS-ES™ Discrete 6.1

DTS-ES Discrete 6.1 is the newest recording format. With it, all 6.1 channels (including the SB channel) are recorded independently using a digital discrete system. The main feature of this format is that because the SL, SR and SB channels are fully independent, the sound can be designed with total freedom and it is possible to achieve a sense that the acoustic images are moving about freely among the background sounds surrounding the listener from 360 degrees.

Though maximum performance is achieved when sound tracks recorded with this system are played using a DTS-ES decoder, when played with a conventional DTS decoder the SB channel signals are automatically down-mixed to the SL and SR channels, so none of the signal components are lost.

■ DTS-ES™ Matrix 6.1

With this format, the additional SB channel signals undergo matrix encoding and are input to the SL and SR channels beforehand. Upon playback they are decoded to the SL, SR and SB channels. The performance of the encoder used at the time of recording can be fully matched using a high precision digital matrix decoder developed by DTS, thereby achieving surround sound more faithful to the producer’s sound design aims than with conventional 5.1- or 6.1-channel systems.

In addition, the bit stream format is 100% compatible with conventional DTS signals, so the effect of the Matrix 6.1 format can be achieved even with 5.1-channel signal sources. Of course it is also possible to play DTS-ES Matrix 6.1 encoded sources with a DTS 5.1-channel decoder.

When DTS-ES Discrete 6.1 or Matrix 6.1 encoded sources are decoded with a DTS-ES decoder, the format is automatically detected upon decoding and the optimum playing mode is selected. However, some Matrix 6.1 sources may be detected as having a 5.1-channel format, so the DTS-ES Matrix 6.1 mode must be set manually to play these sources.

(For instructions on selecting the surround mode, see page 139.)

The DTS-ES decoder includes another function, the DTS Neo:6 surround mode for 6.1-channel playback of digital PCM and analog signal sources.

■ DTS Neo:6™ surround

This mode applies conventional 2-channel signals to the high precision digital matrix decoder used for DTS-ES Matrix 6.1 to achieve 6.1-channel surround playback. High precision input signal detection and matrix processing enable full band reproduction (frequency response of 20 Hz to 20 kHz or greater) for all 6.1 channels, and separation between the different channels is improved to the same level as that of a digital discrete system.

DTS Neo:6 surround includes two modes for selecting the optimum decoding for the signal source.

• DTS Neo:6 Cinema

This mode is optimum for playing movies. Decoding is performed with emphasis on separation performance to achieve the same atmosphere with 2-channel sources as with 6.1-channel sources.

This mode is effective for playing sources recorded in conventional surround formats as well, because the in-phase component is assigned mainly to the center channel (C) and the reversed phase component to the surround (SL, SR and SB channels).

• DTS Neo:6 Music

This mode is suited mainly for playing music. The front channel (FL and FR) signals bypass the decoder and are played directly so there is no loss of sound quality, and the effect of the surround signals output from the center (C) and surround (SL, SR and SB) channels add a natural sense of expansion to the sound field.

[4] DTS 96/24

The sampling frequency, number of bits and number of channels used for recording of music, etc., in studios has been increasing in recent years, and there are a growing number of high quality signal sources, including 96 kHz/24 bit 5.1-channel sources.

For example, there are high picture/sound quality DVD video sources with 96 kHz/24 bit stereo PCM audio tracks.

However, because the data rate for these audio tracks is extremely high, there are limits to recording them on two channels only, and since the quality of the pictures must be restricted it is common to only include still pictures.

In addition, 96 kHz/24 bit 5.1-channel surround is possible with DVD audio sources, but DVD audio players are required to play them with this high quality.

DTS 96/24 is a multi-channel digital signal format developed by Digital Theater Systems Inc. in order to deal with this situation.

Conventional surround formats used sampling frequencies of 48 or 44.1 kHz, so 20 kHz was about the maximum playback signal frequency. With DTS 96/24, the sampling frequency is increased to 96 or 88.2 kHz to achieve a wide frequency range of over 40 kHz.

In addition, DTS 96/24 has a resolution of 24 bits, resulting in the same frequency band and dynamic range as 96 kHz/24 bit PCM.

As with conventional DTS Surround, DTS 96/24 is compatible with a maximum of 5.1 channels, so sources recorded using DTS 96/24 can be played in high sampling frequency, multiple channel audio with such normal media as DVD videos and CDs.

Thus, with DTS 96/24, the same 96 kHz/24 bit multi-channel surround sound as with DVD-Audio can be achieved while viewing DVD-Video images on a conventional DVD-Video player (*1). Furthermore, with DTS 96/24 compatible CDs, 88.2 kHz/24 bit multi-channel surround can be achieved using normal CD/LD players (*1).

Even with the high quality multi-channel signals, the recording time is the same as with conventional DTS surround sources.

What's more, DTS 96/24 is fully compatible with the conventional DTS surround format, so DTS 96/24 signal sources can be played with a sampling frequency of 48 kHz or 44.1 kHz on conventional DTS or DTS-ES surround decoders (*2).

*1: A DVD player with DTS digital output capabilities (for CD/LD players, a player with digital outputs for conventional DTS CDs/LDs) and a disc recorded in DTS 96/24 are required.

*2: The resolution is 24 or 20 bits, depending on the decoder.

[5] Home THX Cinema Surround

THX is an exclusive set of standards and technologies established by the world-renowned film production company, THX Ltd. THX grew from George Lucas' personal desire to make your experience of the film soundtrack, in both movie theaters and in your home theater, as faithful as possible to what the director intended.

Movie soundtracks are mixed in special movie theaters called dubbing stages and are designed to be played back in movie theaters with similar equipment and conditions. The soundtrack created for movie theaters is then transferred directly onto Laserdisc, VHS tape, DVD, etc., and is not changed for playback in a small home theater environment.

THX engineers developed patented technologies to accurately translate the sound from the movie theater environment into the home, correcting the tonal and spatial errors that occur. On the AVR-5805, when the Home THX Cinema mode is on, THX post-processing is automatically added after the Dolby Pro Logic, Dolby Digital or DTS decoder:

Re-Equalization™

The tonal balance of a film soundtrack will be excessively bright and harsh when played back over audio equipment in the home because film soundtracks are designed to be played back in large movie theaters using very different professional equipment. Re-Equalization restores the correct tonal balance for listening to a movie soundtrack in a normal home environment.

Timbre Matching™

The human ear changes our perception of a sound depending on the direction from which the sound is coming. In a movie theater, there is an array of surround speakers so that the surround information is all around you. In a home theater, only two speakers located to the side of your head are used. The Timbre Matching feature filters the information going to the surround speakers so that they more closely match the tonal characteristics of the sound coming from the front speakers. This ensures seamless panning between the front and surround speakers.

Adaptive Decorrelation™

In a movie theater, a large number of surround speakers help create an enveloping surround sound experience, while in a home theater there are usually only two speakers. This can make the surround speakers sound like headphones that lack spaciousness and envelopment. The surround sounds will also collapse into the closest speaker as you move away from the middle seating position. Adaptive Decorrelation slightly changes one surround channel's time and phase relationship with respect to the other surround channel. This expands the listening position and creates—with only two speakers—the same spacious surround experience as in a movie theater.

THX Ultra2™

Before any home theater component can be THX Ultra2 certified, it must incorporate all the features above and also pass a rigorous series of quality and performance tests. Only then can a product feature the THX Ultra2 logo, which is your guarantee that the Home Theater products you purchase will give you superb performance for many years to come. THX Ultra2 requirements cover every aspect of the product including power amplifier performance, pre-amplifier performance and operation, as well as hundreds of other parameters in both the digital and analog domain.

In addition to improvements to the power amplifier with respect to previous THX Ultra standards, two surround modes have been added: the THX Ultra2 Cinema mode, THX Music Mode and THX Games Mode.

THX Ultra2 Cinema

THX Ultra2 Cinema mode plays 5.1 movies using all 8 speakers giving you the best possible movie watching experience. In this mode, new THX processing blends the side surround speakers and back surround speakers providing the optimal mix of ambient and directional surround sounds.

DTS-ES (Matrix and 6.1 Discrete) and Dolby Digital Surround EX encoded soundtracks will be automatically detected in Ultra2 Cinema mode if the appropriate flag has been encoded.

Some Dolby Digital Surround EX soundtracks are missing the digital flag that allows automatic switching. If you know that the movie that you are watching is encoded in Surround EX, you can manually select the THX Surround EX playback mode, otherwise THX Ultra2 Cinema mode will apply processing to provide optimum replay.

THX Music Mode

For the replay of 5.1 multi-channel music the THX MusicMode should be selected. In this mode new THX processing is applied to the surround channels of all 5.1 encoded music sources such as DTS and Dolby Digital to provide a wide stable rear soundstage.

THX Games Mode

- THX Games Mode operating on 5.1 game material
Game Audio is mixed and monitored in a different environment than that of music and movies. The interactive nature of the audio requires a playback system which can provide 360 degree panning while preserving the ambient nature of background sound elements. When playing back 5.1 games, the THX Games Mode should be selected. Suitable sources are DTS 5.1 and Dolby Digital 5.1 game sources.
- THX Games Mode operating on 2.0 game material
2.0 game audio requires a different operation than that of multi channel game sources. When playing back 2.0 games, the THX Games Mode button should be selected. Suitable sources are 2.0 game audio tracks such as Stereo analog, 2.0 PCM, or 2.0 Dolby Digital and 2.0 DTS.

Advanced Speaker Array

ASA processing offers maximum effect when two surround back speakers are used and the speakers are placed near each other. This technology is used for Ultra2 Cinema, THX Music Mode, THX Games mode and THX Surround EX.

Boundary Gain Compensation

When using a THX Ultra2 compatible subwoofer or a subwoofer with ultra-low frequency playback capabilities (with a frequency response extending to approximately 20 Hz), the low frequency band may rise and the sound may seem booming. This technology compensates the gain and makes the audible level flat.

THX, Home THX, Re-Equalization, Timbre Matching, Adaptive Decorrelation, Advanced Speaker Array and THX Ultra are trademarks of THX Ltd.

[6] THX Surround EX

In 1999, a new surround system was launched simultaneously with the release of the movie "Star Wars Episode I". "Dolby Digital Surround EX" is a new movie sound track that greatly enhances the sense of spatial expression and the positioning of the surround channel sound. The result is 360 degrees of movement and moving sound effects that seem to pass right over the listener's head.

This system was developed jointly by THX and Dolby Laboratories, fusing THX's idea of improving spatial expression and achieving a uniform 360 degree sound positioning with Dolby Laboratories' matrix encoding technology. Emphasis was placed on compatibility with the existing system Dolby Digital 5.1-channel, and the new "surround back (SB) channel" was added to achieve improvements over the conventional 5.1-channel system in terms of the positioning of the sound at the rear, the acoustic image of sound moving from the two sides to the back as well as sound moving from the front to the center rear with the multi surround speaker systems used in movie theaters, thereby enabling various types of surround sound.

The surround back channel signal is a matrix-encoded signal inserted into both the Dolby Digital SL (surround left) and SR (surround right) channels. Upon playback, the signals are decoded by a high precision digital matrix decoder within the Dolby Digital decoder into the SL, SR and SB channels and output as 6.1 channels of signals. With the AVR-5805, the signals further undergo Home THX Cinema processing to achieve a THX Surround EX system.

Even without the proper environment for playing the SB channel, Dolby Digital Surround EX signals are 100% compatible with existing 5.1-channel playback systems, so they can be played as such. In this case, the SB channel signal is produced as a monaural signal from both the SL and SR channels, so none of the signal components are missing. The effects specific to THX Surround EX (the sense of spatial expression and the positioning of the sound), however, are the same as with conventional 5.1-channel surround systems.

THX and Ultra 2 are trademarks or registered trademarks of THX Ltd. Surround EX is a jointly developed technology of THX and Dolby Laboratories, Inc. and is a trademark of Dolby Laboratories, Inc. Used under authorization. All rights reserved.

Audyssey MultEQ XT

There are several factors that can degrade the sound from even the best loudspeakers in a listening room. One of the most important is the interaction of sound from the loudspeakers with large surfaces such as walls, the floor, and the ceiling in the room. Even with careful loudspeaker placement and acoustical treatments, there are significant problems that are caused by room acoustics. These include reflections from nearby surfaces and standing waves that are created between large parallel surfaces in the room.

In a home theater the situation is further complicated because there are several listening locations. The effects of room acoustics on the sound arriving at each person's ears are very different and the result is a listening experience that is degraded in a different way for every person in the room. It is not uncommon to have variations in two adjacent seats that are as large as 10 dB, particularly in the frequency range below 250 Hz.

The solution to this problem is to apply room correction after precisely measuring how each loudspeaker interacts with the room. Because the room causes variations in the frequency response of the loudspeakers that are so large from seat to seat, it is important to measure each loudspeaker at several locations in the listening room. This should be done even if there is only one listener. Measurement at a single location is not representative of the acoustical problems in the room and will, in most cases, degrade overall performance.

Audyssey MultEQ XT is the only technology that can achieve room correction for multiple listeners in a large listening area. It does so by combining the data collected at several points in the room from each loudspeaker and then applying correction that minimizes the acoustical effects of the room and is matched to the frequency resolution of human perception (known as psychoacoustics). Furthermore, MultEQ XT correction is applied both in frequency and time domains and so there are no artifacts (such as smearing of sound or modal ringing) that are sometimes associated with traditional methods of room equalization.

In addition to correcting frequency response problems over a wide listening area, Audyssey MultEQ XT provides a completely automated sound system set-up process. It identifies how many loudspeakers are connected to the amplifiers and whether they are full-range, satellites, or subwoofers. If there is at least one subwoofer connected, Audyssey MultEQ XT determines the optimum crossover frequency between each satellite and the subwoofer(s). It automatically checks the polarity of each loudspeaker and alerts the user if there are any that may be wired out-of-phase relative to the others. It measures the distance to each loudspeaker from the main listening position and adjusts the delays so that sound from each loudspeaker arrives at the same time. Finally, Audyssey MultEQ XT determines the playback level of each loudspeaker and adjusts the volume trims so that all levels are equal.

The two diagrams below illustrate two examples of microphone placement for two types of seating arrangements. There are six measuring positions shown in each case. Increasing the number of measuring points will provide a better sampling of the listening area and produce better results. The dotted line represents the area in which the room correction provided by Audyssey MultEQ XT is optimal. The microphone must be placed at ear height at each location.

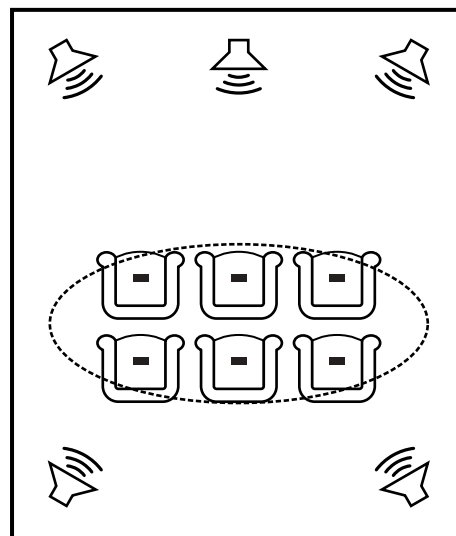
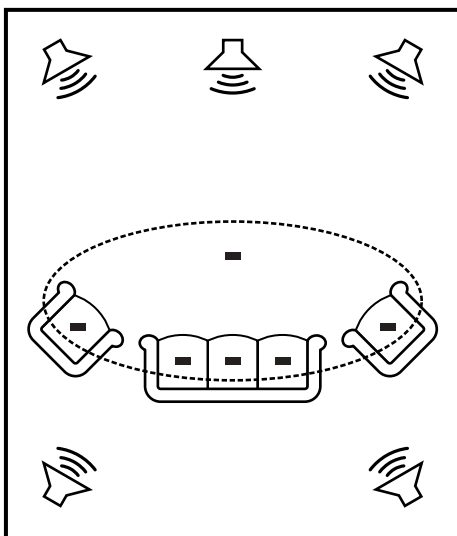

- Audyssey MultEQ XT is a trademark of Audyssey Laboratories. It is licensed under US and National Patent Applications 20030235318 and 10/700,220. Additional U.S. and Foreign Patents pending. MultEQ and the Audyssey MultEQ logo are trademarks of Audyssey Laboratories, Inc.. All rights reserved.

HDCD® (High Definition Compatible Digital®)

HDCD is an encoding/decoding technology that greatly reduces the distortion that occurs upon digital recording while maintaining compatibility with the conventional CD format, thus expanding the dynamic range and achieving a high resolution.

Conventional CDs and HDCD compatible CDs are identified automatically to select the optimum digital processing.



- ®, HDCD®, High Definition Compatible Digital® and Microsoft® are either registered trademarks or trademarks of Microsoft Corporation, Inc. in the United States and/or other countries. HDCD system manufactured under license from Microsoft Corporation, Inc. This product is covered by one or more of the following: In the USA: 5,479,168, 5,638,074, 5,640,161, 5,808,574, 5,838,274, 5,854,600, 5,864,311, 5,872,531, and in Australia: 669114. Other patents pending.

DENON LINK (DENON Digital Link)

High-grade LPCM 24-bit, 96-kHz, 6-channel or 24-bit, 192-kHz, 2-channel digital input is possible when the AVR-5805 is connected via a shielded twisted pair (STP) cable to a Denon DVD player that supports Denon Digital Link. Since Denon Digital Link uses low-voltage differential signaling (LVDS), transfer capabilities of greater than 1.2 Gbps at a differential voltage of approximately 0.3Vpp are possible.

About IEEE1394

IEEE1394 is an international standard established by the Institute of Electrical and Electronics Engineers (IEEE) of the United States.

The AVR-5805 can be connected to an IEEE1394 compatible device using an IEEE1394 cable to enable digital transfer of multi-channel audio sources (DVD Audio discs, Super Audio CDs, etc.) with a single cable.

- The AVR-5805's transfer format is compatible with A&M protocol.
In addition to A&M protocol, IEEE1394 transfer formats also include MPEG-TS, DV, etc.
- The AVR-5805 is compatible with a data transfer speed of up to S400.
The IEEE1394 maximum data transfer speeds are defined as approximately 100, 200 or 400 Mbps, expressed respectively as S100, S200 and S400.
- The AVR-5805 is compatible with the DTCP (Digital Transmission Content Protection) system.

■ Copyright protection system

In order to play the sound of DVD Audio discs, Super Audio CDs or DVDs (aside from freely copiable discs) using IEEE1394 connections, both the player and receiver must be compatible with the DTCP (Digital Transmission Content Protection) system.

DTCP is a copy protection technology that involves data encryption and authentication of the other device. Refer to your player's operating instructions.

The AVR-5805's IEEE1394 device interface is designed based on the standards below.

- 1) IEEE Std. 1394a-2000, Standard for High Performance Serial Bus
- 2) Audio and Music Data Transmission Protocol 2.0

It is compatible with IEC60958 bit stream, DVD-Audio and SACD within AM824 sequence adaptation layers within these standards.

About HDMI

"HDMI" is the abbreviation of "High Definition Multimedia Interface".

This is a digital interface standard for next generation TVs developed based on the DVI (Digital Visual Interface) used for computer displays, etc., and optimized for use in non-professional equipment. With it, non-compressed digital video and multi-channel audio signals can be transferred with a single connector, eliminating the need to use separate cables for the picture and sound and making it possible to make connectors smaller. HDMI is also compatible with HDCP (High-bandwidth Digital Contents Protection), a technology for protecting copyrights that encrypts digital video signals in the same way as with DVI.



HDMI, the HDMI logo and High-Definition Multimedia Interface are trademarks or registered trademarks of HDMI Licensing LLC.

Advanced AL24 Processing

■ Equipped with "Advanced AL24 Processing" – time base area data quantity extension

In addition to "AL24 Processing Plus", the conventional bit extension technology, the PCM signal (CD/digital) playback system also includes the newly developed "Advanced AL24 Processing", a unique high speed signal detection and processing technology that greatly improves the amount of data in the time base area. In addition to extension of the original 16-bit data into 24 bits, "Advanced AL24 Processing" conducts data interpolation on the time axis, in other words up-convert sampling, to achieve natural interpolation processing without harming the original data. In addition, the digital filter offers expanded flexibility, including pulse response with no ringing. Optimum filtering processing is performed even for pulsive music data and attack sounds. All this makes it possible to recreate the delicate nuances of the music and such space information as the positions of the performers, the width, height and depth of the place of the performance (stage), and so on.

Surround modes and parameters

Mode	Signals and adjustability in the different modes									
	Channel output					Parameter (default values are shown in parentheses)				
	FRONT L/R	CENTER	SURROUND L/R (A/B)	SURROUND BACK L/R	SUB-WOOFER	When playing Dolby Digital and DTS signals			SB CH OUT (MODE)	TONE CONTROL
						D. COMP	LFE	AFDM		
PURE DIRECT, DIRECT	○	×	×	×	⊙	○ (OFF)	○ (0dB)	×	×	×
MULTI CH DIRECT	○	⊙	⊙	⊙	⊙	×	×	×	○	×
STEREO	○	×	×	×	⊙	○ (OFF)	○ (0dB)	×	×	○ (0dB)
EXTERNAL INPUT	○	⊙	⊙	⊙	⊙	×	×	×	×	○ (0dB)
MULTI CH IN	○	⊙	⊙	⊙	⊙	×	×	×	○	○ (0dB)
WIDE SCREEN	○	⊙	⊙	⊙	⊙	○ (OFF)	○ (0dB)	×	○	○ (0dB)
HOME THX CINEMA	○	⊙	⊙	⊙	⊙	○ (OFF)	×	×	○	×
DOLBY PRO LOGIC IIx	○	⊙	⊙	⊙	⊙	○ (OFF)	×	×	○	○ (0dB)
DOLBY PRO LOGIC II	○	⊙	⊙	⊙	⊙	○ (OFF)	×	×	○	○ (0dB)
DOLBY DIGITAL	○	⊙	⊙	⊙	⊙	○ (OFF)	○ (0dB)	○	○	○ (0dB)
DTS SURROUND	○	⊙	⊙	⊙	⊙	○ (OFF)	○ (0dB)	○	○	○ (0dB)
DTS NEO:6	○	⊙	⊙	⊙	⊙	○ (OFF)	×	×	○	○ (0dB)
9CH STEREO	○	⊙	⊙	⊙	⊙	○ (OFF)	○ (0dB)	×	○	○ (0dB)
SUPER STADIUM	○	⊙	⊙	⊙	⊙	○ (OFF)	○ (0dB)	×	○	○ (Note 1)
ROCK ARENA	○	⊙	⊙	⊙	⊙	○ (OFF)	○ (0dB)	×	○	○ (Note 2)
JAZZ CLUB	○	⊙	⊙	⊙	⊙	○ (OFF)	○ (0dB)	×	○	○ (0dB)
CLASSIC CONCERT	○	⊙	⊙	⊙	⊙	○ (OFF)	○ (0dB)	×	○	○ (0dB)
MONO MOVIE	○	⊙	⊙	⊙	⊙	○ (OFF)	○ (0dB)	×	○	○ (0dB)
VIDEO GAME	○	⊙	⊙	⊙	⊙	○ (OFF)	○ (0dB)	×	○	○ (0dB)
MATRIX	○	⊙	⊙	⊙	⊙	○ (OFF)	○ (0dB)	×	○	○ (0dB)
VIRTUAL	○	×	×	×	⊙	○ (OFF)	○ (0dB)	×	×	○ (0dB)

○ : Signal / Adjustable
 × : No signal / Not adjustable
 ⊙ : Turned on or off by speaker configuration setting

○ : Able
 × : Unable
 Note1 : BASS +6 dB, TREBLE 0 dB
 Note2 : BASS +6 dB, TREBLE +4 dB

Mode	Signals and adjustability in the different modes											
	Parameter (default values are shown in parentheses)											EXT. IN ONLY
	CINEMA EQ.	MODE	ROOM SIZE	EFFECT LEVEL	DELAY TIME	SUBWOOFER ON/OFF	PRO LOGIC II/IIx MUSIC MODE ONLY			NEO:6 MUSIC MODE ONLY		
							PANORAMA	DIMENSION	CENTER WIDTH		CENTER IMAGE	
PURE DIRECT, DIRECT	×	×	×	×	×	○	×	×	×	×	×	×
MULTI CH DIRECT	×	×	×	×	×	×	×	×	×	×	×	×
STEREO	×	×	×	×	×	×	×	×	×	×	×	×
EXTERNAL INPUT	×	×	×	×	×	×	×	×	×	×	×	○
MULTI CH IN	×	×	×	×	×	×	×	×	×	×	×	×
WIDE SCREEN	○ (OFF)	×	×	○ (ON, 10)	×	×	×	×	×	×	×	×
HOME THX CINEMA	×	○ (PL IIx C)	×	×	×	×	×	×	×	×	×	×
DOLBY PRO LOGIC IIx	○ (OFF)	○ (CINEMA)	×	×	×	×	○ (OFF)	○ (3)	○ (3)	×	×	×
DOLBY PRO LOGIC II	○ (OFF)	○ (CINEMA)	×	×	×	×	○ (OFF)	○ (3)	○ (3)	×	×	×
DOLBY DIGITAL	○ (OFF)	×	×	×	×	×	×	×	×	×	×	×
DTS SURROUND	○ (OFF)	×	×	×	×	×	×	×	×	×	×	×
DTS NEO:6	○ (OFF)	○ (CINEMA)	×	×	×	×	×	×	×	○ (0.3)	×	×
9CH STEREO	×	×	×	×	×	×	×	×	×	×	×	×
SUPER STADIUM	×	×	○ (Medium)	○ (10)	×	×	×	×	×	×	×	×
ROCK ARENA	×	×	○ (Medium)	○ (10)	×	×	×	×	×	×	×	×
JAZZ CLUB	×	×	○ (Medium)	○ (10)	×	×	×	×	×	×	×	×
CLASSIC CONCERT	×	×	○ (Medium)	○ (10)	×	×	×	×	×	×	×	×
MONO MOVIE	×	×	○ (Medium)	○ (10)	×	×	×	×	×	×	×	×
VIDEO GAME	×	×	×	×	×	×	×	×	×	×	×	×
MATRIX	×	×	×	×	○ (30msec)	×	×	×	×	×	×	×
VIRTUAL	×	×	×	×	×	×	×	×	×	×	×	×

○ : Signal / Adjustable
 × : No signal / Not adjustable
 ⊙ : Turned on or off by speaker configuration setting

○ : Adjustable
 × : Not adjustable

■ Differences in surround mode names depending on the input signals

Surround Mode	Input signals						
	ANALOG	LINEAR PCM	DTS			DOLBY DIGITAL	
			DTS (5.1 ch)	DTS 96/24 (5.1 ch)	DTS (6.1 ch)	D. D. (2 ch)	D. D. (5.1 ch)
PURE DIRECT, DIRECT STEREO	○	○	○	○	○	○	○
HOME THX CINEMA	PLIIx C+THX PLII C+THX DOLBY PL+THX NEO:6 C+THX THX GAMES MODE	PLIIx C+THX PLII C+THX DOLBY PL+THX NEO:6 C+THX THX GAMES MODE	*THX MTRX6.1 THX Ultra2 Cinema THX MUSIC MODE THX GAMES MODE PLIIx C+THX THX5.1	*THX MTRX6.1 THX Ultra2 Cinema THX MUSIC MODE THX GAMES MODE PLIIx C+THX THX5.1	◎ THX DSCRT6.1 THX MTRX6.1 PLIIx C+THX	PLIIx C+THX PLII C+THX DOLBY PL+THX NEO:6 C+THX THX GAMES MODE	*THX SURROUND EX THX Ultra2 Cinema THX MUSIC MODE THX GAMES MODE PLIIx C+THX THX5.1
DTS SURROUND	×	×	Ⓜ DTS ES MTRX DTS+Neo:6 DTS SURROUND DTS+PL IIx	Ⓜ DTS ES MTRX DTS 96/24 DTS 96/24+Neo:6 DTS+PL IIx	◎ DTS ES DSCRT6.1 DTS MTRX6.1 DTS+PL IIx	×	×
DTS NEO:6	DTS NEO:6	DTS NEO:6	×	×	×	DTS NEO:6	×
DOLBY DIGITAL	×	×	×	×	×	×	Ⓜ DOLBY DIGITAL EX DOLBY DIGITAL+PL IIx
DOLBY PRO LOGIC II DOLBY PRO LOGIC IIx	Ⓜ DOLBY PRO LOGIC IIx PRO LOGIC II	Ⓜ DOLBY PRO LOGIC IIx PRO LOGIC II	×	×	×	Ⓜ DOLBY PRO LOGIC IIx PRO LOGIC II	×
DSP SIMULATION	○	○	○	○	○	○	○

- : Selectable
- * The surround mode name differs depending on the "MODE/SB CH OUT" surround parameter setting.
- ◎ : The surround mode name differs depending on the input signal.
- Ⓜ : Not selectable

Relationship between the video input signal and monitor output according to the VIDEO CONVERT MODE settings of MAIN ZONE

VIDEO CONVERT Mode	VIDEO SCALER setting	Input signals			MONITOR OUT		
		COMPONENT	S-VIDEO	VIDEO	COMPONENT	S-VIDEO	VIDEO
AUTO	Not applicable	×	×	○	VIDEO	VIDEO	VIDEO
	Not applicable	×	○	×	S-VIDEO	S-VIDEO	S-VIDEO
	Not applicable	×	○	○	S-VIDEO	S-VIDEO	S-VIDEO
	Other than 480i/576i	○ (Other than 480i/576i)	×	×	COMPONENT	×	×
	480i / 576i	○ (480i / 576i)	×	×	COMPONENT	COMPONENT	COMPONENT
	Other than 480i/576i	○ (480i / 576i)	×	×	COMPONENT	COMPONENT	COMPONENT
	Not applicable	○ (Other than 480i/576i)	×	○	COMPONENT *1	VIDEO	VIDEO
	480i / 576i	○ (480i / 576i)	×	○	COMPONENT *1	VIDEO	VIDEO
	Other than 480i/576i	○ (480i / 576i)	×	○	COMPONENT *1	COMPONENT	COMPONENT
	Not applicable	○ (Other than 480i/576i)	○	×	COMPONENT *2	S-VIDEO	S-VIDEO
	480i / 576i	○ (480i / 576i)	○	×	COMPONENT *2	S-VIDEO	S-VIDEO
	Other than 480i/576i	○ (480i / 576i)	○	×	COMPONENT *2	COMPONENT	COMPONENT
	Not applicable	○ (Other than 480i/576i)	○	○	COMPONENT *2	S-VIDEO	S-VIDEO
	480i / 576i	○ (480i / 576i)	○	○	COMPONENT *2	S-VIDEO	S-VIDEO
Other than 480i/576i	○ (480i / 576i)	○	○	COMPONENT *2	COMPONENT	COMPONENT	

VIDEO CONVERT Mode	Input signals			MONITOR OUT		
	COMPONENT	S-VIDEO	VIDEO	COMPONENT	S-VIDEO	VIDEO
COMPONENT	×	×	○	×	×	×
	×	○	×	×	×	×
	×	○	○	×	×	×
	○ (Other than 480i/576i)	×	×	COMPONENT	×	×
	○ (480i / 576i)	×	×	COMPONENT	COMPONENT	COMPONENT
	○ (Other than 480i/576i)	×	○	COMPONENT	×	×
	○ (480i / 576i)	×	○	COMPONENT	COMPONENT	COMPONENT
	○ (Other than 480i/576i)	○	×	COMPONENT	×	×
	○ (480i / 576i)	○	×	COMPONENT	COMPONENT	COMPONENT
	○ (Other than 480i/576i)	○	○	COMPONENT	×	×
○ (480i / 576i)	○	○	COMPONENT	COMPONENT	COMPONENT	

VIDEO CONVERT Mode	Input signals			MONITOR OUT		
	COMPONENT	S-VIDEO	VIDEO	COMPONENT	S-VIDEO	VIDEO
S-VIDEO	×	×	○	×	×	×
	×	○	×	S-VIDEO	S-VIDEO	S-VIDEO
	×	○	○	S-VIDEO	S-VIDEO	S-VIDEO
	○	×	×	×	×	×
	○	×	○	×	×	×
	○	○	×	S-VIDEO	S-VIDEO	S-VIDEO
	○	○	○	S-VIDEO	S-VIDEO	S-VIDEO

VIDEO CONVERT Mode	Input signals			MONITOR OUT		
	COMPONENT	S-VIDEO	VIDEO	COMPONENT	S-VIDEO	VIDEO
VIDEO	×	×	○	VIDEO	VIDEO	VIDEO
	×	○	×	×	×	×
	×	○	○	VIDEO	VIDEO	VIDEO
	○	×	×	×	×	×
	○	×	○	VIDEO	VIDEO	VIDEO
	○	○	×	×	×	×
	○	○	○	VIDEO	VIDEO	VIDEO

VIDEO CONVERT Mode	S-VIDEO MONITOR OUT	Input signals			MONITOR OUT		
		COMPONENT	S-VIDEO	VIDEO	COMPONENT	S-VIDEO	VIDEO
OFF	Not applicable	×	×	○	×	×	VIDEO
	Not applicable	×	○	×	×	S-VIDEO	×
	Used	×	○	○	×	S-VIDEO	* VIDEO
	Not used	×	○	○	×	-	VIDEO
	Not applicable	○	×	×	COMPONENT	×	×
	Not applicable	○	×	○	COMPONENT *1	×	VIDEO
	Not applicable	○	○	×	COMPONENT *2	S-VIDEO	×
	Used	○	○	○	COMPONENT *2	S-VIDEO	* VIDEO
	Not used	○	○	○	COMPONENT *1	-	VIDEO

○ : Signal input
 × : No signal

× : Not output
 * VIDEO : No OSD
 COMPONENT : On-screen display only displayed for SYSTEM SETUP, Surr.PARA and ON SCREEN buttons
 COMPONENT *1 : On-screen display superimposed on video signal and output
 COMPONENT *2 : On-screen display superimposed on S-video signal and output

- The MAIN ZONE video conversion function is compatible with the following formats: NTSC, PAL, SECAM, NTSC 4.43, PAL-N, PAL-M and PAL-60.
- When composite input SECAM signals are up-converted, the signals are output in PAL format from the S-Video connector.

Relationship between the video input signal and monitor output according to the VIDEO CONVERT MODE settings of ZONE2

VIDEO CONVERT Mode	Input signals			MONITOR OUT		
	COMPONENT	S-VIDEO	VIDEO	COMPONENT	S-VIDEO	VIDEO
AUTO	×	×	○	VIDEO	VIDEO	VIDEO
	×	○	×	S-VIDEO	S-VIDEO	S-VIDEO
	×	○	○	S-VIDEO	S-VIDEO	S-VIDEO
	○	×	×	COMPONENT	×	×
	○	×	○	COMPONENT *1	VIDEO	VIDEO
	○	○	×	COMPONENT *2	S-VIDEO	S-VIDEO
	○	○	○	COMPONENT *2	S-VIDEO	S-VIDEO

VIDEO CONVERT Mode	Input signals			MONITOR OUT		
	COMPONENT	S-VIDEO	VIDEO	COMPONENT	S-VIDEO	VIDEO
COMPONENT	×	×	○	×	×	×
	×	○	×	×	×	×
	×	○	○	×	×	×
	○	×	×	COMPONENT	×	×
	○	×	○	COMPONENT	×	×
	○	○	×	COMPONENT	×	×
	○	○	○	COMPONENT	×	×

VIDEO CONVERT Mode	Input signals			MONITOR OUT		
	COMPONENT	S-VIDEO	VIDEO	COMPONENT	S-VIDEO	VIDEO
S-VIDEO	×	×	○	×	×	×
	×	○	×	S-VIDEO	S-VIDEO	S-VIDEO
	×	○	○	S-VIDEO	S-VIDEO	S-VIDEO
	○	×	×	×	×	×
	○	×	○	×	×	×
	○	○	×	S-VIDEO	S-VIDEO	S-VIDEO
	○	○	○	S-VIDEO	S-VIDEO	S-VIDEO

VIDEO CONVERT Mode	Input signals			MONITOR OUT		
	COMPONENT	S-VIDEO	VIDEO	COMPONENT	S-VIDEO	VIDEO
VIDEO	×	×	○	VIDEO	VIDEO	VIDEO
	×	○	×	×	×	×
	×	○	○	VIDEO	VIDEO	VIDEO
	○	×	×	×	×	×
	○	×	○	VIDEO	VIDEO	VIDEO
	○	○	×	×	×	×
	○	○	○	VIDEO	VIDEO	VIDEO

VIDEO CONVERT Mode	S-VIDEO MONITOR OUT	Input signals			MONITOR OUT		
		COMPONENT	S-VIDEO	VIDEO	COMPONENT	S-VIDEO	VIDEO
OFF	Not applicable	×	×	○	×	×	VIDEO
	Not applicable	×	○	×	×	S-VIDEO	×
	Used	×	○	○	×	S-VIDEO	* VIDEO
	Not used	×	○	○	×	-	VIDEO
	Not applicable	○	×	×	COMPONENT	×	×
	Not applicable	○	×	○	COMPONENT	×	VIDEO
	Not applicable	○	○	×	COMPONENT	S-VIDEO	×
	Used	○	○	○	COMPONENT	S-VIDEO	* VIDEO
Not used	○	○	○	COMPONENT	-	VIDEO	

○ : Signal input
 × : No signal

× : Not output
 * VIDEO : No OSD
 COMPONENT : On-screen display only displayed for SYSTEM SETUP, SURRE.PARA and ON SCREEN buttons
 COMPONENT *1 : On-screen display superimposed on video signal and output
 COMPONENT *2 : On-screen display superimposed on S-video signal and output

- The ZONE 2 video conversion function is compatible with the NTSC and PAL formats.

18 SPECIFICATIONS

■ Audio section

- **Power amplifier**
Rated output:

Front:
170 W + 170 W (8 Ω/ohms, 20 Hz ~ 20 kHz with 0.05% T.H.D.)
200 W + 200 W (6 Ω/ohms, 20 Hz ~ 20 kHz with 0.05% T.H.D.)

Center:
170 W (8 Ω/ohms, 20 Hz ~ 20 kHz with 0.05% T.H.D.)
200 W (6 Ω/ohms, 20 Hz ~ 20 kHz with 0.05% T.H.D.)

Surround (A, B):
170 W + 170 W (8 Ω/ohms, 20 Hz ~ 20 kHz with 0.05% T.H.D.)
200 W + 200 W (6 Ω/ohms, 20 Hz ~ 20 kHz with 0.05% T.H.D.)

Surround Back:
170 W + 170 W (8 Ω/ohms, 20 Hz ~ 20 kHz with 0.05% T.H.D.)
200 W + 200 W (6 Ω/ohms, 20 Hz ~ 20 kHz with 0.05% T.H.D.)

Dynamic power:

190 W x 2 ch (8 Ω/ohms)
310 W x 2 ch (4 Ω/ohms)
All channels: 6 ~ 16 Ω/ohms

Output terminals:

- **Analog**

Input sensitivity / input impedance:

200 mV / 47 kΩ/kohms

Frequency response:

10 Hz ~ 100 kHz: +0, -3 dB (DIRECT mode)

S/N:

105 dB (DIRECT mode)

Distortion:

0.005% (20 Hz ~ 20 kHz) (DIRECT mode)

Rated output:

1.2 V

- **Digital**

D/A output:

Rated output — 2 V (at 0 dB playback)
Total harmonic distortion — 0.003% (1 kHz, at 0 dB)
S/N ratio — 125 dB
Dynamic range — 117 dB
Format — Digital audio interface

Digital input:

- **Phono equalizer (PHONO input — REC OUT)**

Input sensitivity:

2.5 mV

RIAA deviation:

±1 dB (20 Hz to 20 kHz)

S/N:

74 dB (A weighting, with 5 mV input)

Rated output / Maximum output:

150 mV / 8 V

Distortion factor:

0.03% (1 kHz, 3 V)

■ Video section

- **Standard video jacks**

Input / output level and impedance:

1 Vp-p, 75 Ω/ohms

Frequency response:

5 Hz ~ 10 MHz — +0, -3 dB

- **S-video jacks**

Input / output level and impedance:

Y (brightness) signal — 1 Vp-p, 75 Ω/ohms

C (color) signal — 0.286 Vp-p, 75 Ω/ohms

Frequency response:

5 Hz ~ 10 MHz — +0, -3 dB

- **Color component video terminal**

Input / output level and impedance:

Y (brightness) signal — 1 Vp-p, 75 Ω/ohms

PB/CB (blue) signal — 0.7 Vp-p, 75 Ω/ohms

PR/CR (red) signal — 0.7Vp-p, 75 Ω/ohms

Frequency response:

5 Hz ~ 100 MHz — +0, -3 dB

■ Tuner section

Receiving Range:

[FM] (note: μV at 75 Ω/ohms, 0 dBf = 1×10^{-15} W)

87.5 MHz ~ 107.9 MHz

[AM]

520 kHz ~ 1710 kHz

Usable Sensitivity:

1.0 μV (11.2 dBf)

18 μV

50 dB Quieting Sensitivity:

MONO 1.6 μV (15.3 dBf)

STEREO 23 μV (38.5 dBf)

50 dB

S/N (IHF-A):

MONO 77 dB

STEREO 72 dB

Total Harmonic Distortion (at 1 kHz):

MONO 0.15%

STEREO 0.3%

■ **General**

Power supply:	AC 120 V, 60 Hz
Power consumption:	13 A
Maximum external dimensions:	434 (W) x 280 (H) x 505 (D) mm (17-3/32" x 11-1/32" x 19-7/8")
Mass:	44.0 kg (97 lbs)

■ **Remote control unit (RC-995)**

Batteries:	R03/AAA Type (four batteries)
External dimensions:	72 (W) x 238 (H) x 25.5 (D) mm (2-53/64" x 9-3/8" x 1-0")
Mass:	225 g (Approx. 8 oz) (including batteries)

* For purposes of improvement, specifications and design are subject to change without notice.

DENON, Ltd.

TOKYO, JAPAN
www.denon.com